

TOSHIBA

TOSHIBA Bar Code Printer

B-SV4D-GS/GC10-QM

External Equipment Interface Specification

First Edition: Jun. 02, 2003
Second Edition: Feb. 20, 2006

TOSHIBA TEC CORPORATION

TABLE OF CONTENTS

	Page
1. SCOPE.....	1
2. GENERAL DESCRIPTION.....	1
3. INTERFACE.....	2
3.1 SERIAL INTERFACE.....	2
3.2 PARALLEL INTERFACE.....	6
4. KEY OPERATION FUNCTIONS.....	8
4.1 SYSTEM MODE (POWER UP WITH KEY PRESSED).....	8
4.2 ON-LINE MODE FUNCTIONS.....	9
5. TRANSMISSION SEQUENCE.....	10
5.1 INITIALIZATION.....	10
5.2 LABEL ISSUE OPERATION.....	12
6. INTERFACE COMMANDS.....	14
6.1 OUTLINE OF COMMANDS.....	14
6.2 LIST OF COMMANDS.....	16
6.3 COMMANDS FOR CREATING APPLICATION.....	17
6.3.1 LABEL SIZE SET COMMAND.....	17
6.3.2 POSITION FINE ADJUST COMMAND.....	22
6.3.3 PRINT DENSITY FINE ADJUST COMMAND.....	27
6.3.4 IMAGE BUFFER CLEAR COMMAND.....	28
6.3.5 CLEAR AREA COMMAND.....	29
6.3.6 LINE FORMAT COMMAND.....	31
6.3.7 BIT MAP FONT FORMAT COMMAND.....	35
6.3.8 OUTLINE FONT FORMAT COMMAND.....	49
6.3.9 BAR CODE FORMAT COMMAND.....	63
6.3.10 BIT MAP FONT DATA COMMAND.....	94
6.3.11 OUTLINE FONT DATA COMMAND.....	97
6.3.12 BAR CODE DATA COMMAND.....	100
6.3.13 ISSUE COMMAND.....	113
6.3.14 FEED COMMAND.....	123
6.3.15 EJECT COMMAND.....	128
6.3.16 FORWARD/REVERSE FEED COMMAND.....	129
6.3.17 STORAGE AREA ALLOCATE COMMAND.....	131
6.3.18 MEMORY CARD FORMAT COMMAND.....	133
6.3.19 2-BYTE WRITABLE CHARACTER CODE RANGE COMMAND.....	134
6.3.20 BIT MAP WRITABLE CHARACTER COMMAND.....	135

	Page
6.3.21 GRAPHIC COMMAND	146
6.3.22 SAVE START COMMAND	154
6.3.23 SAVE TERMINATE COMMAND	156
6.3.24 SAVED DATA CALL COMMAND	157
6.3.25 RESET COMMAND	158
6.3.26 STATUS REQUEST COMMAND	159
6.3.27 RECEIVE BUFFER FREE SPACE STATUS REQUEST COMMAND	160
6.3.28 VERSION INFORMATION ACQUIRE COMMAND	162
6.3.29 MEMORY BOARD INFORMATION ACQUIRE COMMAND	163
6.3.30 PRINTER INFORMATION STORE COMMAND	165
6.3.31 PRINTER INFORMATION REQUEST COMMAND	166
6.4 COMMANDS FOR SYSTEM ADMINISTRATOR	167
6.4.1 PARAMETER SET COMMAND	167
6.4.2 FINE ADJUSTMENT VALUE SET COMMAND	170
6.4.3 BATCH RESET COMMAND	172
7. CONTROL CODE SELECTION	173
8. ERROR PROCESSING	174
8.1 COMMUNICATION ERRORS	174
8.2 ERRORS IN ISSUING OR FEEDING	174
8.3 ERRORS IN WRITABLE CHARACTER AND PC COMMAND SAVE MODES	176
9. STATUS RESPONSE	177
9.1 SERIAL INTERFACE	177
9.1.1 FUNCTIONS	177
9.1.2 STATUS FORMAT	177
9.1.3 DETAIL STATUS	178
9.2 PARALLEL INTERFACE	179
10. LED INDICATIONS	181

	Page
11. CHARACTER CODE TABLE	183
11.1 TIMES ROMAN, HELVETICA, LETTER GOTHIC, PRESTIGE ELITE, COURIER.....	183
11.2 PRESENTATION.....	190
11.3 TEC OUTLINE FONT 1	194
11.4 TrueType FONT.....	201
12. BAR CODE TABLE	208
13. DRAWING OF BAR CODE DATA.....	221
14. AUTOMATIC ADDING OF START/STOP CODE	242

1. SCOPE

This specification applies to the external equipment interface for use with the Model B-SV4D general-purpose thermal label/tag printers.

2. GENERAL DESCRIPTION

The external equipment interface connects a printer to the host computer through a serial interface (RS-232C), parallel interface (Centronics), or a network for making various settings and printing labels.

This specification describes how to use the external equipment interface.

The model configuration is described below.

		B-SV4D
Memory	Flash ROM	1 MB
	DRAM	2 MB
Interface	Standard	RS-232C Centronics USB
	Option	LAN adapter
Cutter		Full cut
		Partial cut (option)
Strip module		Option

3. INTERFACE

3.1 SERIAL INTERFACE

- (1) Type : Conforming to RS-232C
- (2) Mode of Communication : Full duplex
- (3) Transmission Speed : 2400 BPS
4800 BPS
9600 BPS
19200 BPS
38400 BPS
57600 BPS
- (4) Synchronization Method : Start-stop synchronization
- (5) Start Bit : 1 bit
- (6) Stop Bit : 1 bit
2 bits
- (7) Data Length : 7 bits
8 bits
- (8) Parity : None
Even
Odd
- (9) Error Detection : Parity Error Vertical parity error check
Framing Error This error occurs if no stop bit is found in the frame specified starting with the start bit.
Overrun Error This error occurs if the next data is input before the data input to the UART from the host is read by the printer CPU.
- (10) Protocol : No-procedure method
- (11) Data Input Code : ASCII code
European character set 8 bit code
Graphics 8 bit code
- (12) Receive Buffer : 515K bytes

(13) Transmission Control : XON/XOFF (DC1/DC3) Protocol
READY/BUSY (DTR) Protocol
XON/XOFF (DC1/DC3) Protocol + READY/BUSY (DTR)

Protocol

RTS Protocol

① XON/XOFF (DC1/DC3) Protocol

- When initialized after power on, this printer becomes ready to receive data and sends an XON code (11H). (Transmission or non-transmission of the XON code is selectable by means of the parameter setting.)
- The printer sends an XOFF code (13H) when the blank positions in the receive buffer become 1K bytes or less.
- The printer sends an XON code (11H) when the blank positions in the receive buffer are 2K bytes or more.
- When there are no blank positions in the receive buffer, the printer discards data received exceeding the receive buffer capacity, without storing it in the buffer. (After detecting the XOFF code, the host computer must stop transmission before the printer receive buffer becomes full.)
- The printer sends an XOFF code (13H) when the power is off. (Transmission or non-transmission of the XOFF code is selectable by means of the parameter setting.)

② READY/BUSY (DTR) Protocol

- When initialized after power on, this printer becomes ready to receive data and turns the DTR signal to "High" level (READY).
- The printer turns the DTR signal to "Low" level (BUSY) when the blank positions in the receive buffer are 1K bytes or less.
- The printer turns the DTR signal to "High" level (READY) when the blank positions in the receive buffer are 2K bytes or more.
- When there are no blank positions in the receive buffer, the printer discards data received exceeding the receive buffer capacity, without storing it in the buffer. (After detecting the BUSY signal, the host computer must stop transmission before the printer receive buffer becomes full.)
- The RTS signal is always "High".

③ XON/XOFF (DC1/DC3) Protocol + READY/BUSY (DTR) Protocol

- When initialized after power on, this printer becomes ready to receive data and turns the DTR signal to “High” level (READY). The printer also sends an XON code (11H).
- When the blank positions in the receive buffer are 1K bytes or less, the printer turns the DTR signal to “Low” level (BUSY) and sends an XOFF code (13H).
- When the blank positions in the receive buffer are 2K bytes or more, the printer turns the DTR signal to “High” level (READY) and sends an XON code (11H).
- When there are no blank positions in the receive buffer, the printer discards data received exceeding the receive buffer capacity, without storing it in the buffer. (After detecting the XOFF code or BUSY signal, the host computer must stop transmission before the printer receive buffer becomes full.)
- The printer sends an XOFF code (13H) when the power is off.
- The RTS signal is always “High”.

④ RTS Protocol

- When initialized after the power is turned on, this printer turns the RTS signal to “High” (READY).
- The printer turns the RTS signal to “Low” (BUSY) when the blank positions in the receive buffer are 1K bytes or less.
- The printer turns the RTS signal to “High” (READY) when the blank positions in the receive buffer are 2K bytes or more.
- When there are no blank positions in the receive buffer, the printer discards data received exceeding the receive buffer capacity, without storing it in the buffer. (After detecting the BUSY signal, the host computer must stop transmission before the printer receive buffer becomes full.)
- The DTR signal is always “High” (READY).

(14) RS-232 Interface pin configuration

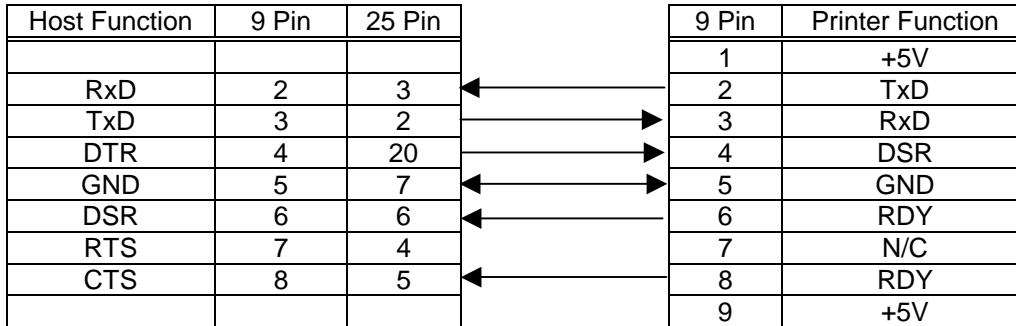

(15) Connector Pin Assignment and Signal Description

Pin No.	Signal Name	Function	Signal Direction
1	+5V	Provide the power of 5V	
2	TxD	Transmit data	Printer →
3	RxD	Receive data	← Host
4	DSR	Data set ready	← Host
5	GND	General Ground	
6	RDY	Printer ready	Printer →
7	N/C	Not connected	
8	RDY	Printer ready	Printer →
9	+5V	Provide the power of 5V	

3.2 PARALLEL INTERFACE

- (1) Type : Centronics
- (2) Mode : Conforms to IEEE1284 compatible mode
- (3) Data Input Method : Parallel 8 bits (DATA1 ~ 8)
- (4) Control Signals : $\overline{\text{ACK}}$, $\overline{\text{BUSY}}$, $\overline{\text{SELECT}}$, $\overline{\text{DATA} \bullet \text{STB}}$, $\overline{\text{FAULT}}$, PE, $\overline{\text{INIT}}$ (Not used),
 $\overline{\text{AUTOFD}}$ (Not used), $\overline{\text{SELECTIN}}$ (Not used)
- (5) Data Input Code : ASCII code
European character set 8 bit code
Graphics 8 bit code
- (6) Receive Buffer : 515K bytes
- (7) Connector : Printer
 - Amp. Japan 552742-1 or equivalent
 - DDK 57RE-40360-73B or equivalent
 - Cable
 - Amp. Japan 552470-1 or equivalent
 - DDK 57E-30360 or equivalent

(8) Connector Pin Diagram:

Pin No.	Signal Name	Pin No.	Signal Name
1	DATA • STB	19	TWISTED PAIR GND (PIN1)
2	DATA 1	20	TWISTED PAIR GND (PIN2)
3	DATA 2	21	TWISTED PAIR GND (PIN3)
4	DATA 3	22	TWISTED PAIR GND (PIN4)
5	DATA 4	23	TWISTED PAIR GND (PIN5)
6	DATA 5	24	TWISTED PAIR GND (PIN6)
7	DATA 6	25	TWISTED PAIR GND (PIN7)
8	DATA 7	26	TWISTED PAIR GND (PIN8)
9	DATA 8	27	TWISTED PAIR GND (PIN9)
10	ACK	28	TWISTED PAIR GND (PIN10)
11	BUSY	29	TWISTED PAIR GND (PIN11)
12	PE	30	TWISTED PAIR GND (PIN31)
13	SELECT	31	INIT (Not used)
14	AUTOFD (Not used)	32	FAULT
15	NC	33	0V
16	0V	34	NC
17	CHASSIS GND	35	NC
18	+5V	36	SELECTIN (Not used)

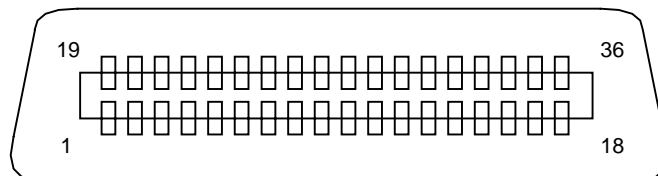

4. KEY OPERATION FUNCTIONS

4.1 SYSTEM MODE (POWER UP WITH KEY PRESSED)

There are 6 LED light indications with following sequence.

- (1) Solid orange indicates the printer has entered into system mode
- (2) Green and red alternate
- (3) Flashing orange
- (4) Green and orange alternate
- (5) Orange and red alternate
- (6) Solid green

4.1.1 Firmware downloading mode

- 1) Release FEED key at LED light sequence (2) and push again immediately.
- 2) Copy the firmware file to printer parallel port by the following command is MS-DOS prompt mode.
C:\>COPY XXXXXX.NEW /B LPT1:
- 3) The LED will change to green color and blinking every one-second. When firmware update is completed, printer will reset automatically.

4.1.2 Auto call cancellation

- 1) Release FEED key at LED light sequence (3).
- 2) The printer will cancel Auto Call execution. (Refer to 6.3.24)

4.1.3 Parameter clearance

- 1) Release FEED key at LED light sequence (4).
- 2) The printer will restore to manufacturer's default setting and reset automatically.

4.1.4 Sensor calibration

- 1) Install a label/tag roll with the sensor located at proper position.
- 2) Release FEED key at LED light sequence (5).
- 3) The printer will set the sensor property for the installed media and measures label length.

4.1.5 Self-test / Dump mode

- 1) Release FEED key at LED light sequence (6).
- 2) The printer will print self-test then enter the dump mode.

[Self-test printing]

a. Printing program version & check sum

b. Printing various parameters

Parameter	Initial value
Print density fine adjustment	0
Print position fine adjustment	0 mm
Amount for finely the cut position	0 mm
Type of character code	PC-850
Font of zero	0 (without slash)
Communication speed	9600 bps
Data length	8 bits
Stop bit length	1 bit
Parity	NONE
Transmission control	2
Forward feed wait	ON
Control code	AUTO
Feed key function	FEED
Euro code	B0 H
X-coordinate adjustment	0 mm
Sensor selection	Transmissive

4.2 ONLINE MODE FUNCTIONS

The online mode provides the following functions for issuing labels.

- (1) Issuing labels (by external equipment interface commands)
- (2) Paper feed (by the [FEED] key)
- (3) Error indication
- (4) Sensor selection

Transmissive sensor, reflective sensor and non-sensor mode are available.

To select the sensor for the media, turn on power to let printer online mode. Open printer cover, the LED will be turned off. Press FEED key for over 5 seconds, and then release the button, then printer will enter sensor selection mode.

In sensor selection mode, if LED is changed to green color and press FEED key again, then reflective sensor is selected.

If LED is changed to orange color and press FEED key again, then non-sensor is selected.

If LED is changed to red color and press FEED key again, then transmissive sensor is selected.

5. TRANSMISSION SEQUENCE

This section describes the outline of the transmission sequence.

5.1 INITIALIZATION

Writable characters, logo, and PC interface commands must be stored before the label issue operation.

(1) Storing writable characters and logo

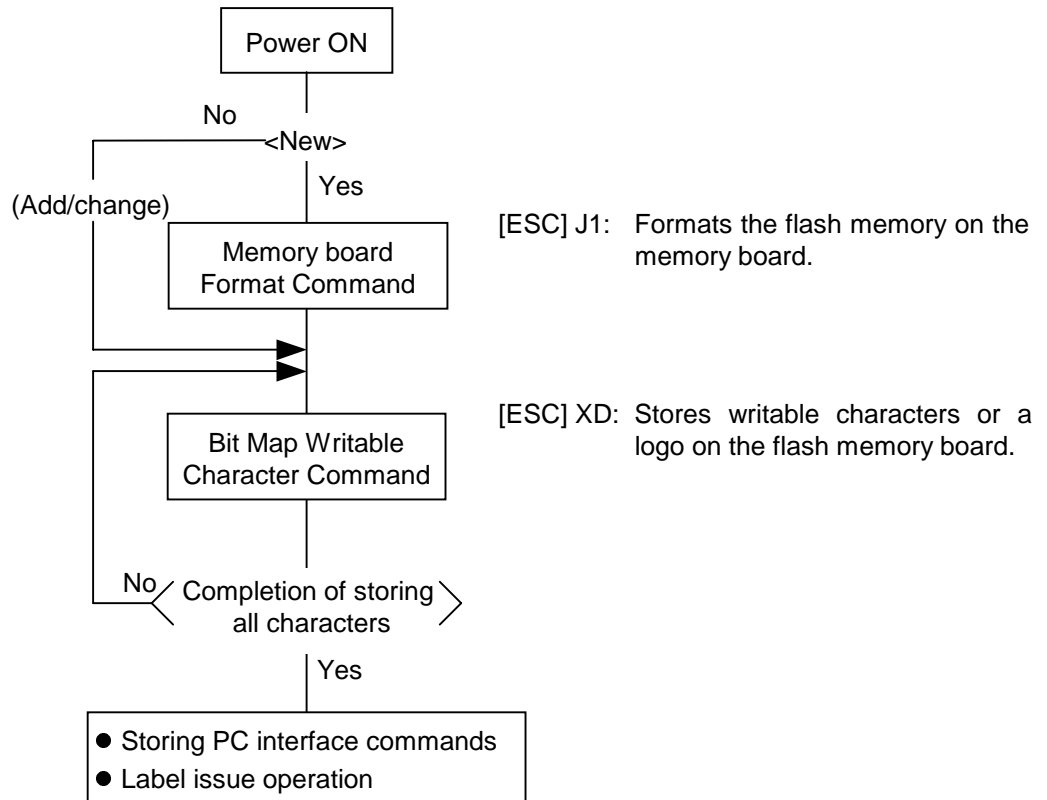

- NOTES:**
- (1) The storage of PC commands is only performed if it is required.
 - (2) When the flash memory board is used, and the Memory board Format Command is not sent before storing already stored writable characters or logos, memory will be taken up with every such storing.
 - (3) When the flash memory board is used, and another operation (storing PC interface commands or label issue operation) is performed after storing writable characters or logos, the image buffer will be cleared automatically.
 - (4) If another storing operation does not take place after storing writable characters or logos, the printer automatically enters the online mode (label issue operation) after about 10 seconds. In this case, when the flash memory board is used, the image buffer will be cleared automatically.

(2) Storing PC interface commands

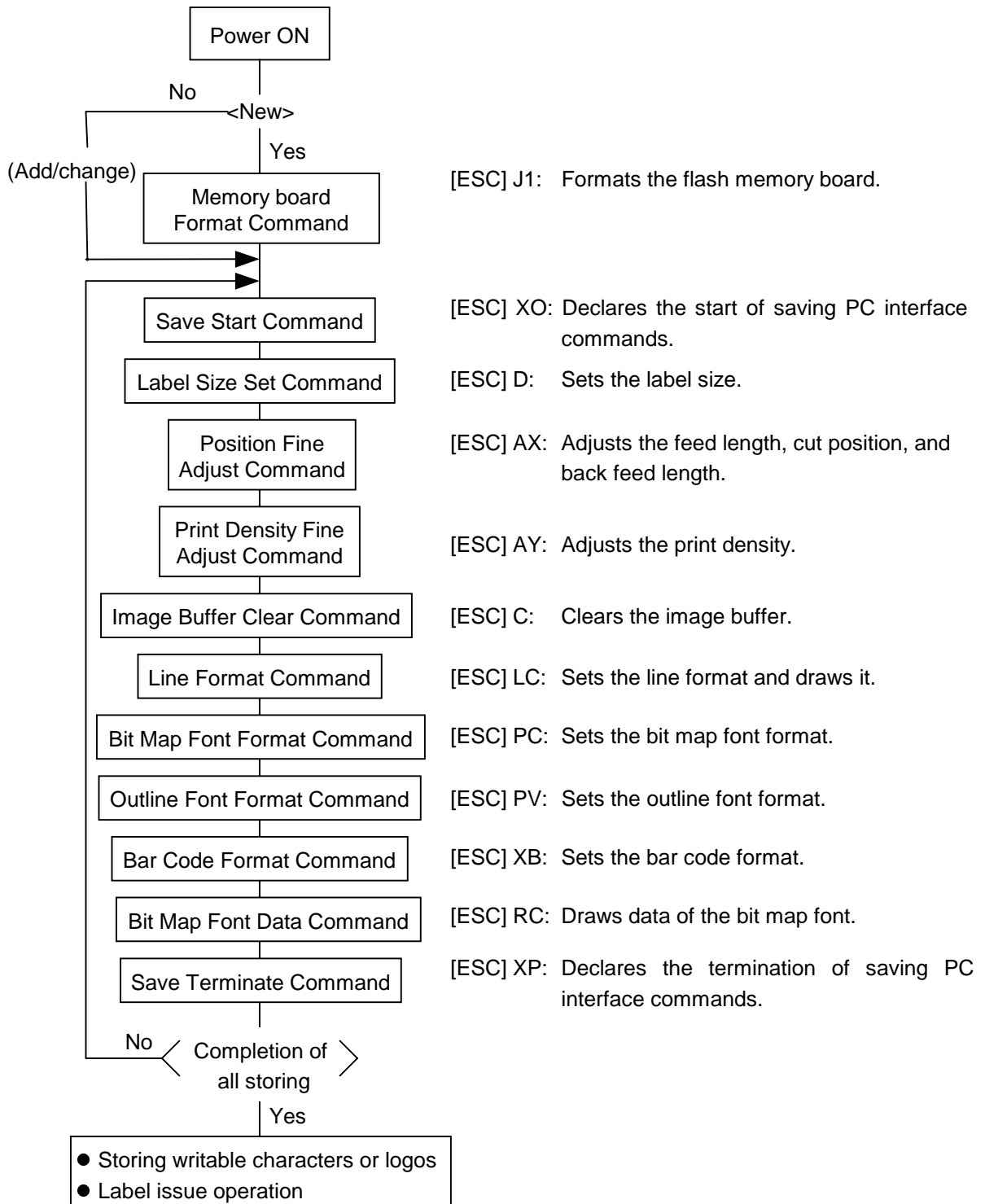

- NOTES:** (1) The storage of PC commands is only performed if it is required.
 (2) When the flash memory card is used, and the Memory board Format Command is not sent before storing already stored PC interface commands, memory will be taken up with every such storing.
 (3) When the flash memory board is used, and another operation (storing writable characters or logos, label issue operation) is performed after storing PC interface commands, the image buffer will be cleared automatically.
 (4) Select commands to be stored as the occasion demands.
 (5) If another storing operation does not take place after storing PC interface commands, the printer enters the online mode (label issue operation) after about 10 seconds. In this case, when the flash memory board is used, the image buffer will be cleared automatically.

5.2 LABEL ISSUE OPERATION

An example of the label issue operation is described below.

(1) Where the Saved Data Call Command is not used:

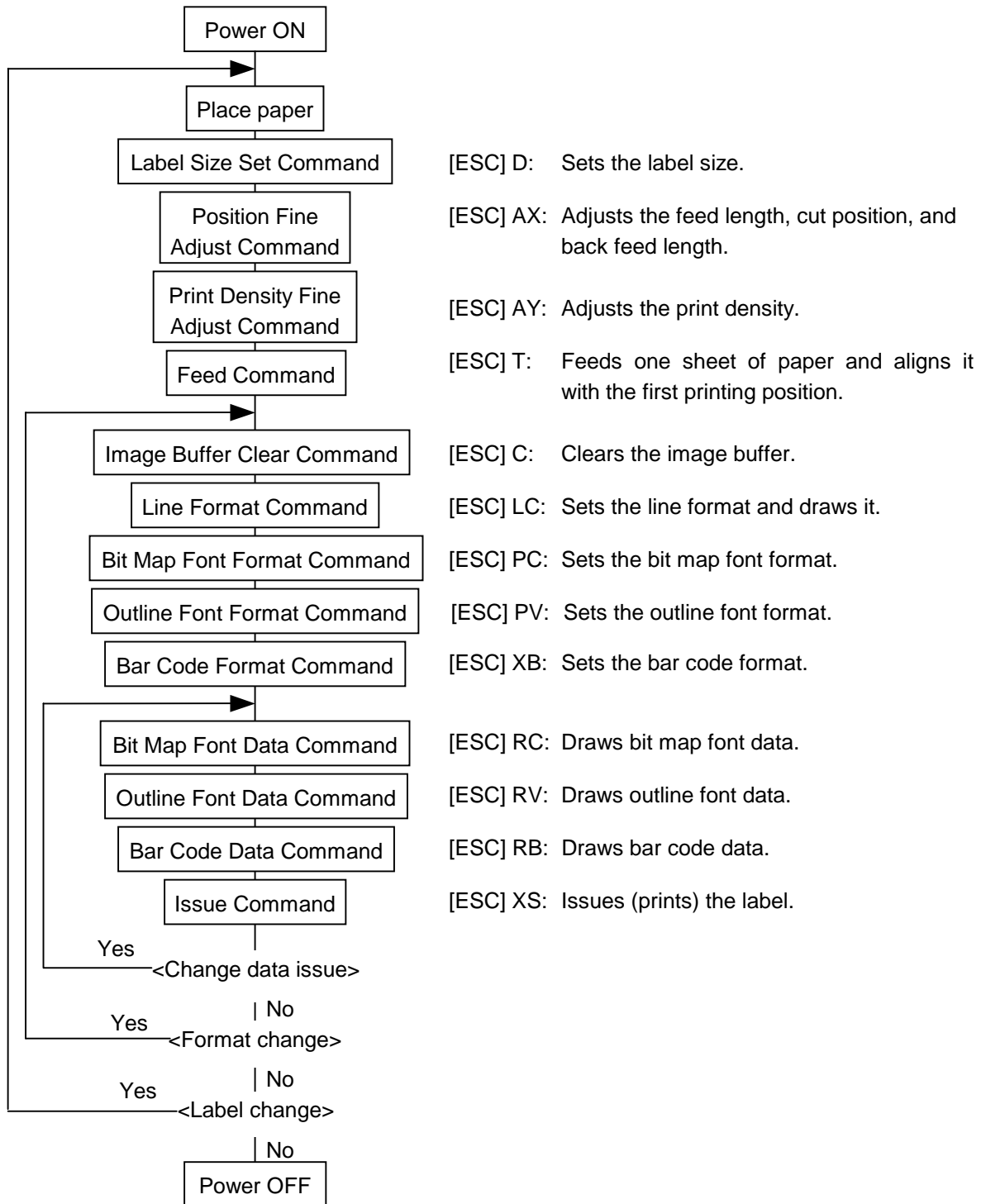

NOTES: (1) When placing new paper, the Label Size Set Command and Feed Command must always be sent. When using the same paper after the power is turned off and on, the Label Size Set Command and Feed Command may be omitted.

(2) After the power is turned off and on, the Bit Map Font Format Command, the Outline Font Format Command, and the Bar Code Format Command should be sent as occasion demands because they are not protected in memory.

(2) Where the Saved Data Call Command is used:

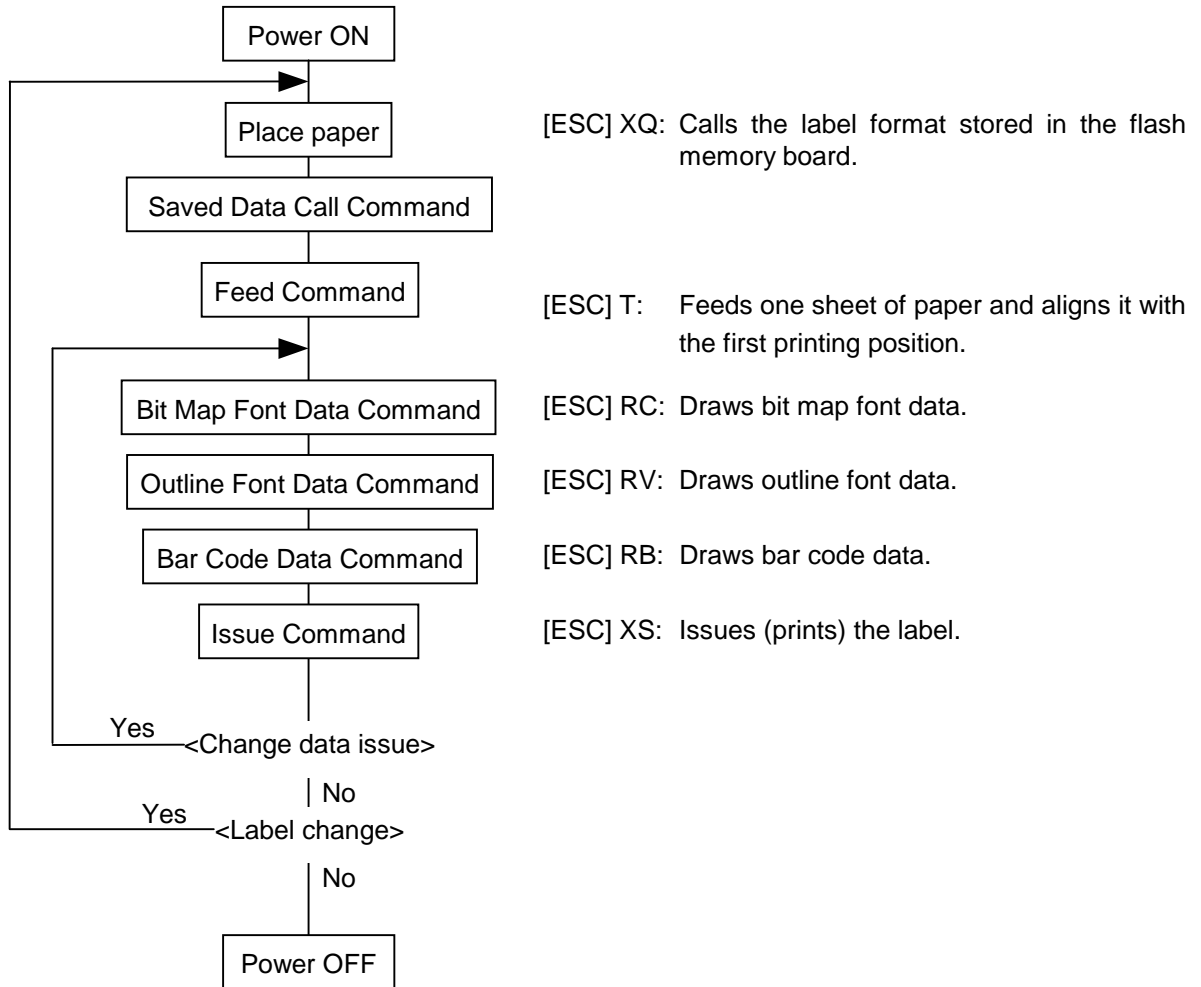

- NOTES:** (1) When placing new paper, the Feed Command must always be sent. When using the same paper after the power is turned off and on, the Feed Command may be omitted.
- (2) If the option for "automatic call at power on" for the Saved Data Call Command has previously been selected, the Saved Data Call Command may be omitted after the power is turned off and on.

6. INTERFACE COMMANDS

6.1 OUTLINE OF COMMANDS

(1) Format of Interface command

ESC	Command & Data	LF	NUL
-----	----------------	----	-----

- The length from [ESC] to [LF] [NUL] must be as specified by each command.
- There are the following three kinds of control codes:
 - ① ESC (1BH), LF (0AH), NUL(00H)
 - ② { (7BH), | (7CH), } (7DH)

(2) How to use reference

Function Describes the outline of the function of the command.

Format Shows the format of the command.

The format designation method should conform to the following rules:

- Each set of small letters (such as aa, bbbb) indicates a parameter item.
- An item enclosed in parentheses may be omitted.
- “...” indicates the repetition of an item.
- Brackets and parentheses are used only in coding, and must not be transmitted in practice.
- Other symbols must always be inserted at the designated positions before being transmitted.

Term Explains the term(s) used in the format.

- “0 to 999” described in the entry range indicates that up to 3-digit variable-length entry is allowed. (Entry of “001” or “009” is also possible.) “000 to 999” indicates that entry must be fixed as 3 digits.

Explanation Explains the command in detail.

Note Supplementary explanation of the command.

Refer to Related commands

Examples Explains the command examples.

[ESC] T20C30 [LF] [NUL]

The above corresponds to the transfer of the following:

1B 54 32 30 43 33 30 0A 00
 [ESC] T 2 0 C 3 0 [LF] [NUL]

(3) Precautions

The commands and parameters described in this specification must always be used. If any command or parameter other than those covered in this specification is used, the printer operation will not be guaranteed. The commands must be used in the online mode. If any command is transmitted in system mode, the printer will not operate. However, only the Reset Command can be used.

NOTES:

1. If a command is not recognized as a command, it is ignored.
e.g.) [ESC] H, [ESC]AA, and so on.
2. If the number of digits of the parameter is specified, when the number of input digits does not match the specified number of digits, a command error occurs.
3. When a parameter is set to any character/value other than specified characters/values, a command error occurs.
e.g.) In the case that a value should be set for parameter, "0001" is acceptable, however, "000A" results in an error.
In the case that a character should be set for parameter, "A" is acceptable, however, "1" results in an error.
4. If the value range of the parameter is specified, when any value beyond the range is entered, a command error occurs. (Except for the D command)
5. When a parameter is missing, which cannot be omitted, a command error occurs.
6. The parameter should be set to either a value or a character, even if the parameter is defined as "Ignore".
e.g.) a : Ignore
If it is omitted, a command error occurs, except when the parameter is omissible.
If the number of digits of the parameter is specified, when the number of input digits does not match the specified number of digits, a command error occurs.
7. When any value/character other than available values/characters for the parameter function is set, a command error occurs.
e.g.) Parameter "e" for the LC command.
e: Type of line
0: Line
1: Rectangle
If "2" is set to parameter "e", a command error occurs.
8. About D command
 - 1) Parameter "aaaa", "bbbb" and "cccc"
When any value larger than maximum value is entered for these three parameters, the entered value is internally changed to the maximum value.
When any value smaller than minimum value is entered for these three parameters, the entered value is internally changed to the minimum value.
 - 2) When "aaaa" is smaller than "cccc", a command error occurs.
 - 3) When "aaaa – cccc < 2mm", it is internally changed to "cccc = aaaa – 2mm".

6.2 LIST OF COMMANDS

(1) Commands related to setting	
Label Size Set Command	[ESC] D 17
(2) Commands related to fine adjustment	
Position Fine Adjust Command	[ESC] AX 22
Print Density Fine Adjust Command	[ESC] AY 27
(3) Commands related to clear	
Image Buffer Clear Command	[ESC] C 28
Clear Area Command	[ESC] XR 29
(4) Commands related to drawing format setting	
Line Format Command	[ESC] LC 31
Bit Map Font Format Command	[ESC] PC 35
Outline Font Format Command	[ESC] PV 49
Bar Code Format Command	[ESC] XB 63
(5) Commands related to print data	
Bit Map Font Data Command	[ESC] RC 94
Outline Font Data Command	[ESC] RV 97
Bar Code Data Command	[ESC] RB 100
(6) Commands related to issue and feed	
Issue Command	[ESC] XS 113
Feed Command	[ESC] T 123
Eject Command	[ESC] IB 128
Forward/Reverse Feed Command (Reserved for future)	[ESC] U1, [ESC] U2 129
(7) Commands related to writable characters	
Storage Area Allocate Command	[ESC] XF 131
Memory Card Format Command	[ESC] J1 133
2-byte Writable Character Code Range Command	[ESC] XE 134
Bit Map Writable Character Command	[ESC] XD 135
(8) Commands related to graphics	
Graphic Command	[ESC] SG 146
(9) Commands related to PC command saving	
Memory Card Format Command	[ESC] J1 133
Save Start Command	[ESC] XO 154
Save Terminate Command	[ESC] XP 156
Saved Data Call Command	[ESC] XQ 157
(10) Commands related to control	
Reset Command	[ESC] WR 158
Batch Reset Command	[ESC] Z0 172
(11) Commands related to status	
Status Request Command	[ESC] WS 159
Receive Buffer Free Space Status Request Command	[ESC] WB 160
Version Information Acquire Command	[ESC] WV, [ESC] WI 162
(12) Commands related to printer information	
Information Store Command	[ESC] IG 165
Information Request Command	[ESC] IR 166
(13) Commands related to parameter setting	
Parameter Set Command	[ESC] Z2;1 167
Fine Adjustment Value Set Command	[ESC] Z2;2 170

6.3 COMMANDS FOR CREATING APPLICATION

6.3.1 LABEL SIZE SET COMMAND

[ESC] D

Function	Sets the size of a label or tag.
Format	[ESC] Daaaa, bbbb, cccc (,ddd) [LF] [NUL]
Term	<p>aaaa: Pitch length of the label or tag 4 and 5 digits (in 0.1 mm units) 4 digits: Max. 6096(609.6 mm) 5 digits: Max. 06096 (609.6 mm)</p> <p>bbbb: Effective print width Fixed as 4 digits (in 0.1 mm units)</p> <p>cccc: Effective print length 4 and 5 digits (in 0.1 mm units) 4 digits: Max. 6096 (609.6 mm) 5 digits: Max. 06096 (609.6 mm)</p> <p>ddd: (Omissible) Function: Ignore</p>

Explanation

[Labels]

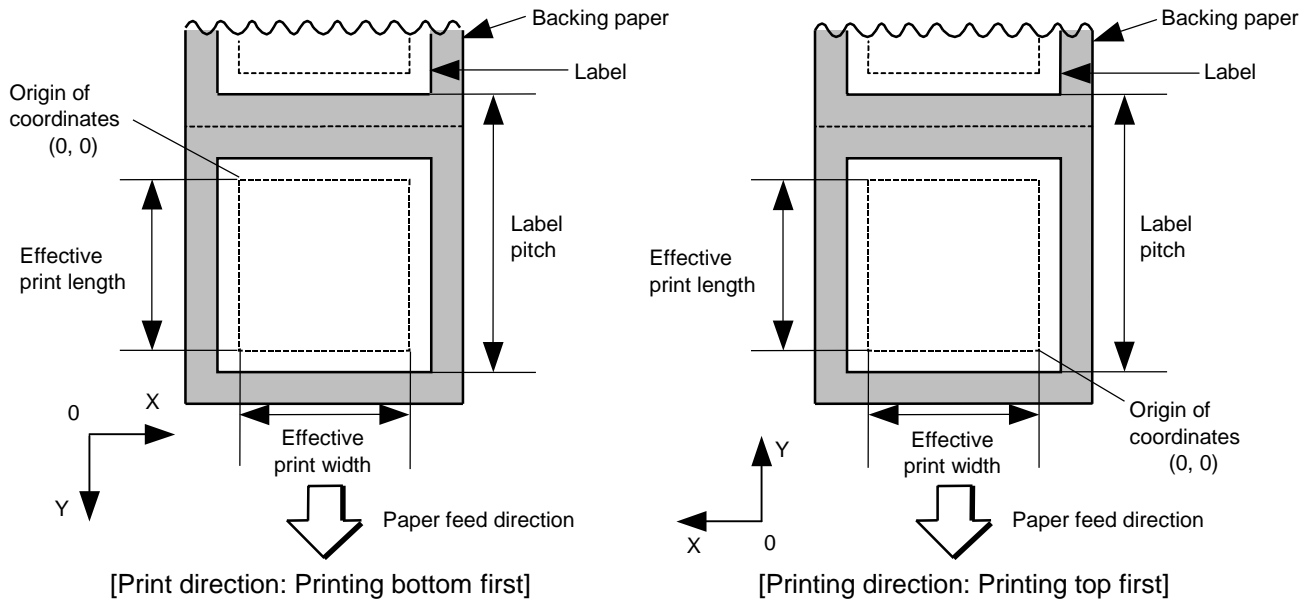

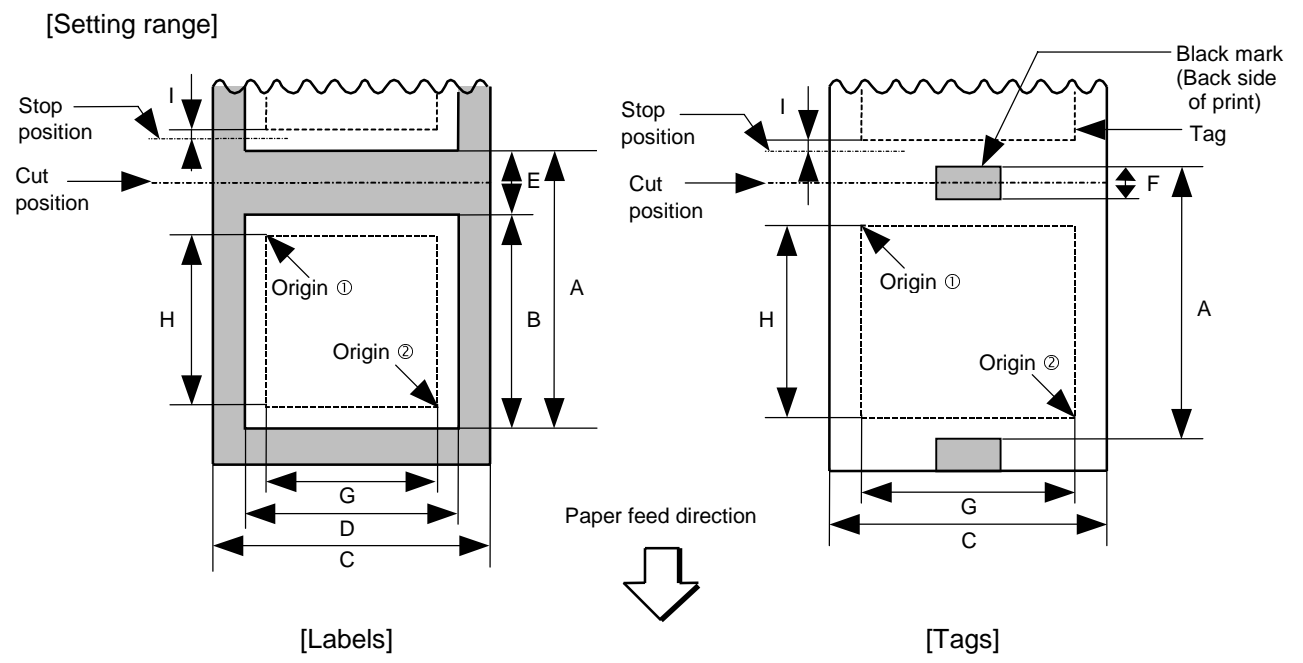
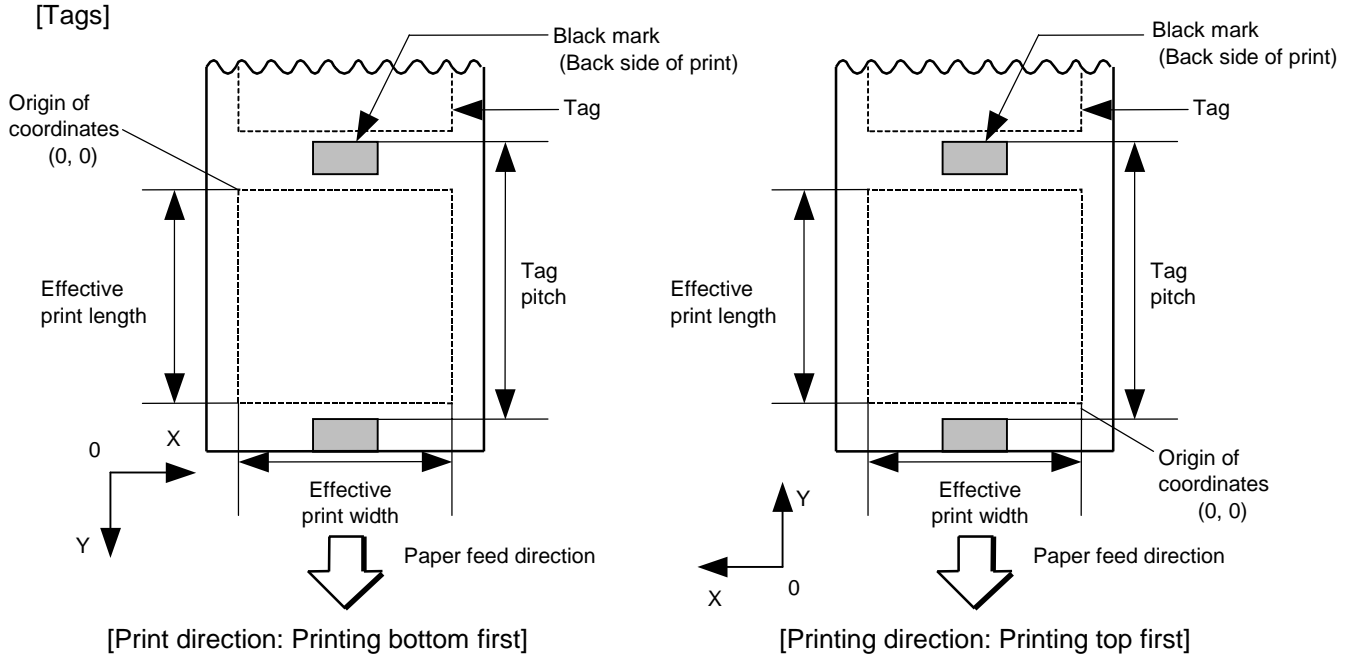

[mm]

Item		Model	B-SV4D		
		Method	Batch	Strip	Cutter
Thermal head dot density		8 dots/mm			
Thermal head width		108			
A: Label pitch Tag pitch	Label	Min.	10.0	25.4	15.0
		Max.	609.6		
	Tag	Min.	10.0	–	15.0
		Max.	609.6		
B: Label length	Min.	10.0	25.4	15.0	
	Max.	607.6			
C: Backing paper width Tag width	Min.	25.4			
	Max.	112			
D: Label width	Min.	22.4			
	Max.	109			
E: Label-to-label gap	Min.	2.0		6.0	
	Max.	10.0			
F: Black mark length	Min.	2.0		6.0	
	Max.	10.0			
G: Effective print width	Min.	13			
	Max.	108 ± 0.2			
H: Effective print length	Label	Min.	8.0	23.4	13.0
		Max.	607.6		
	Tag	Min.	8.0	–	13.0
		Max.	607.6	–	607.6
I: Slow up interval		1.0			

Notes

- (1) Before changing the label size or type of sensor, the Label Size Set Command must first be transmitted.
- (2) The Label Size Set Command is protected in memory (even if the power is turned off).
- (3) After sending the Label Size Set Command, one sheet of paper must be fed by the Feed Command ([ESC] T) and must be aligned with the first print position prior to printing.
- (4) The origin of drawing coordinates, print stop position (head position at stop), and cut position are determined according to the parameters of the Label Size Set Command as shown in the figure on the preceding page. For the print stop position in strip issue mode, refer to the section of the Position Fine Adjust Command. The effective print area is centered on the label/tag.
- (5) Printing cannot be performed in the slow up (1 mm) and slow down (1 mm) areas. Consequently, $[A : \text{label/tag pitch}] - [H : \text{effective print length}] \geq 2 \text{ mm}$ must be assumed.
- (6) The origin of drawing coordinates, print stop position (head position at stop), and cut position are adjustable by the Fine Adjust Commands and according to the fine adjustment settings in System mode.
- (7) The tag rotation designation of the Issue Command ([ESC] XS) causes the origin of drawing coordinates to be origin ① in the case of “printing bottom first” and to be origin ② in the case of “printing top first”, as shown in the figure.
- (8) The parameters must be as shown in the figure and table. Any value or paper outside the range results in a failure of printing or an error.
- (9) The setting for the backing paper width is used for the control of the backing paper rewind motor for a strip issue. Therefore, this setting is not effective for any mode other than strip issue mode.

Examples

(1) Labels

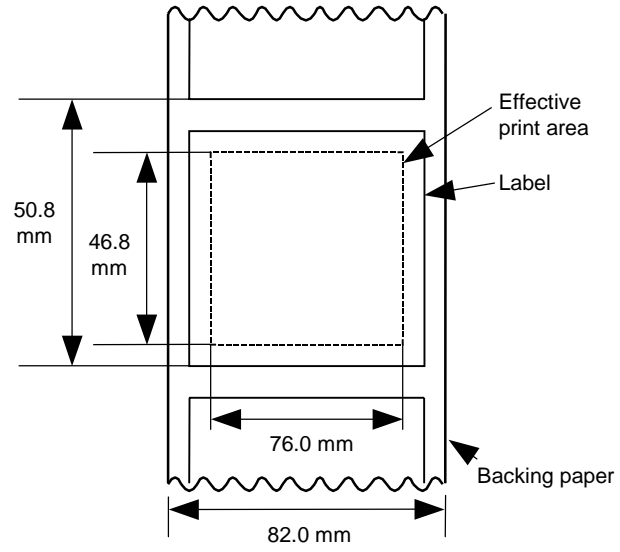

[ESC] D0508, 0760, 0468, 0820 [LF] [NUL]
[ESC] T20C30 [LF] [NUL]

(2) Tags

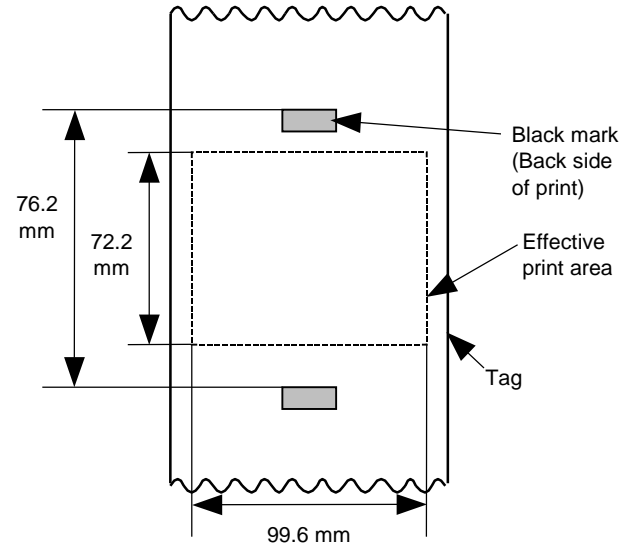

[ESC] D0762, 0996, 0722 [LF] [NUL]
[ESC] T10C30 [LF] [NUL]

6.3.2 POSITION FINE ADJUST COMMAND

[ESC] AX

Function	<ul style="list-style-type: none">① Adjusts the feed value so that the label will be shifted forward or backward from the automatically set first print start position.② Adjusts the cut position so that the label will be cut at a position shifted forward or backward from the automatically set cut position, or adjusts the strip position so that the label will be shifted forward or backward from the automatically set strip position.③ Adjusts the value for feeding the label back to the home position after cutting, or adjusts the value for feeding the label back to the home position after stripping.
Format	[ESC] AX; abbb, cddd, eff [LF] [NUL]
Term	<p>a: Indicates the direction, forward or backward, in which a fine adjustment is to be made. +: Backward -: Forward</p> <p>bbb: Feed value to be finely adjusted. 000 to 500 (in 0.1 mm units)</p> <p>c: Indicates the direction, forward or backward, in which a cut position (or strip position) fine adjustment is to be made. +: Backward -: Forward If cutter and strip module is not installed, this value is ignored.</p> <p>ddd: Amount for finely adjusting the cut position (or strip position). 000 to 350 (in 0.1 mm units) If cutter and strip module is not installed, this value is ignored.</p> <p>e: Indicates whether the back feed is to be increased or decreased. +: Increase -: Decrease</p> <p>ff: Amount for finely adjusting the back feed. 00 to 99 (in 0.1 mm units)</p>

Explanation

[Feed Length Fine Adjustment] (To finely adjust the feed for shifting backward or forward)

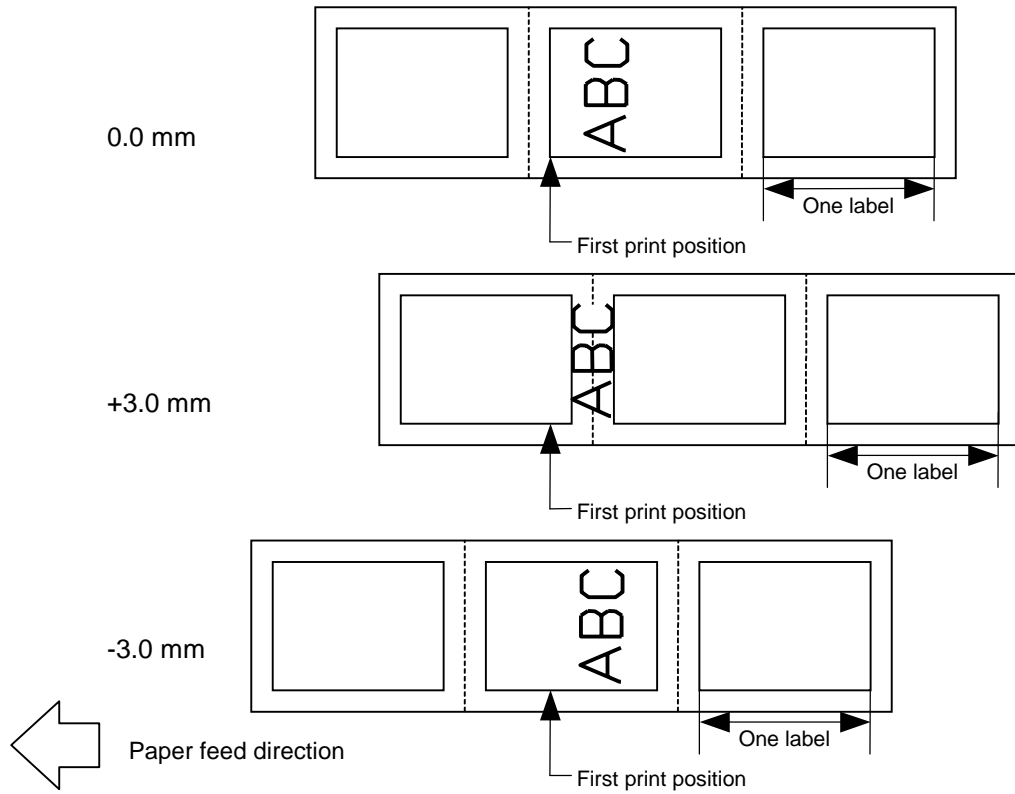

[Cut Position Fine Adjustment] (To finely adjust the cut position for shifting backward or forward)

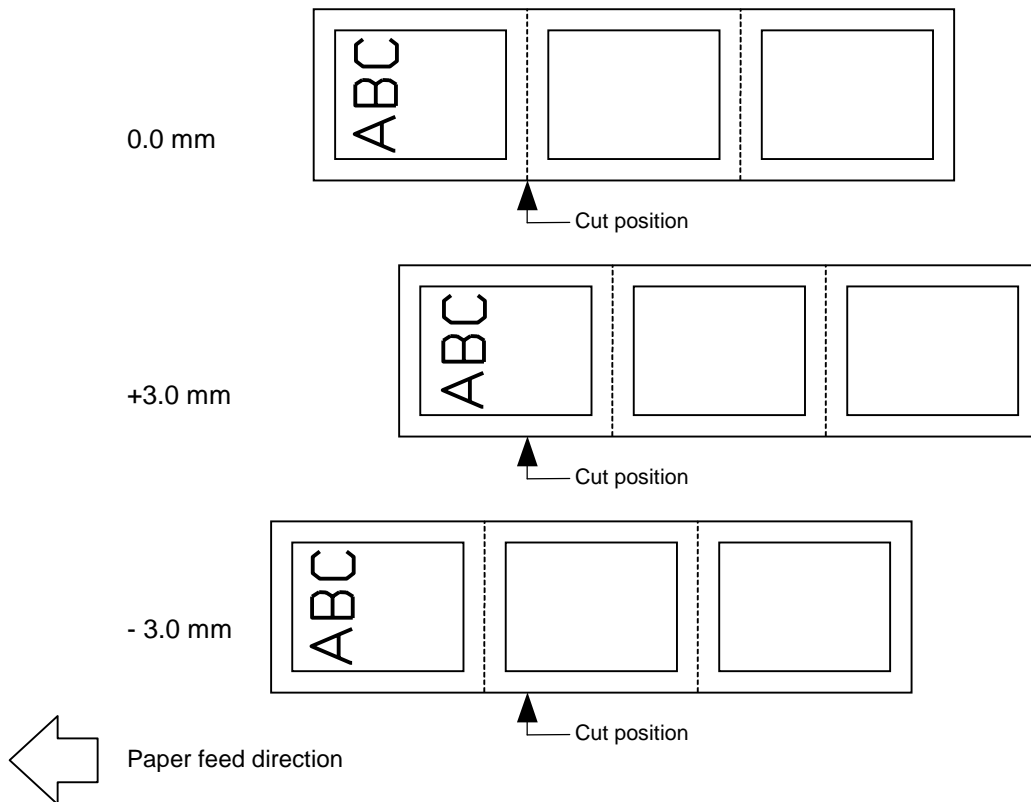

[Strip Position Fine Adjustment]

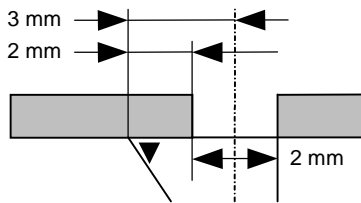
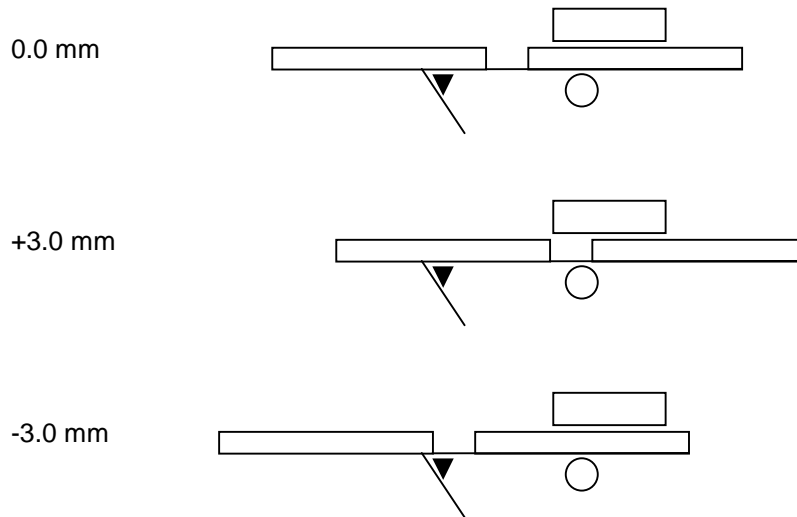

Printing in strip issue mode is stopped at the position where the distance from the middle point of the label-to-label gap to the end of the strip shaft is 3 mm, since the label-to-label gap is assumed to be 2 mm.

When the print stop position is not proper, the print stop position should be adjusted using the strip position fine adjust function. When the label-to-label gap is 5 mm or more, the effective print length should be set to the maximum (label pitch -2 mm). Then, the print stop position should be adjusted using the strip position fine adjust function.

[Back Feed Fine Adjustment] (To finely adjust the back feed for shifting backward or forward)

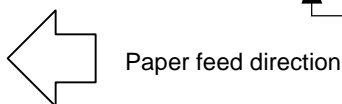
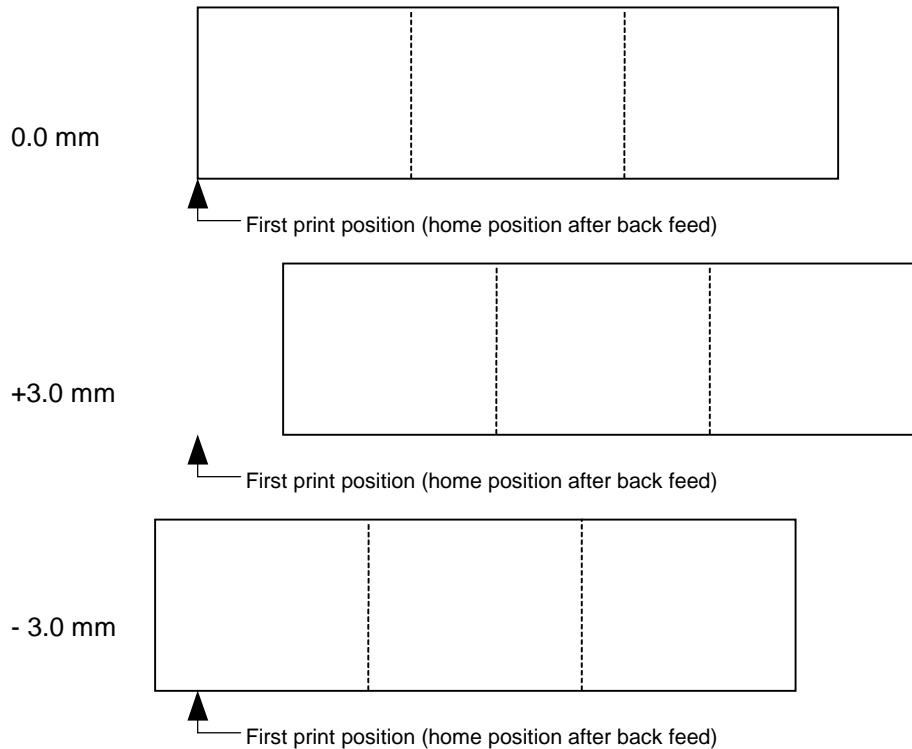

Notes

(1) If the feed value fine adjustment, cut position (or strip position) fine adjustment or back feed value fine adjustment has been set in system mode (key operation on the printer), the fine adjustment value will be the fine adjustment in system mode. The max. fine adjustment values are as follows. However, the max. feed fine adjustment value is limited within the label pitch.

- Feed value fine adjustment.....±50.0 mm
- Cut position (or strip position) fine adjustment.....±35.0 mm
- Back feed value fine adjustment.....±9.9 mm

(2) After changing the fine adjustment value by this command, one label must be fed by the Feed Command ([ESC] T) to adjust the first print position.

(3) Each fine adjustment value is protected in memory (even if the power is turned off).

(4) If a fine adjustment value is improper, printing will not be performed correctly.

(For example, if the back feed fine adjustment value is not set properly, the print positions without cutting and after cutting will be different from each other. If the label is fed back excessively, the paper will not be fed correctly during printing.
In the strip issue mode, the print position may differ between the first label and the second label. The back feed fine adjustment is used to adjust the length so that the label is correctly fed back to the position placed before the forward feed is performed.

(5) The cut position (or the strip position) fine adjustment and back feed value fine adjustment are effective only when the printer is in cut issue or strip issue mode.

Examples

(1) Cut issue

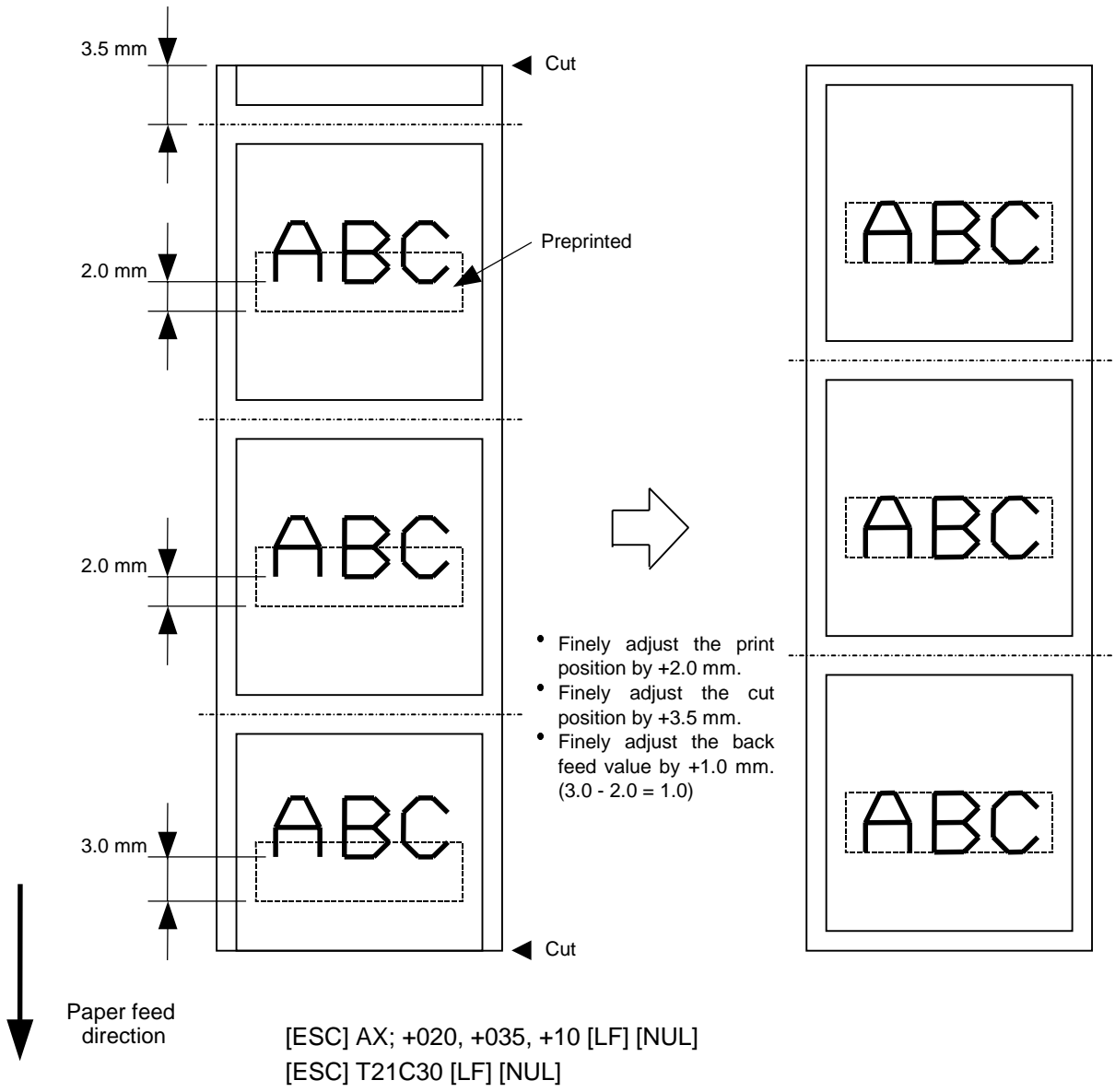

(2) Strip issue

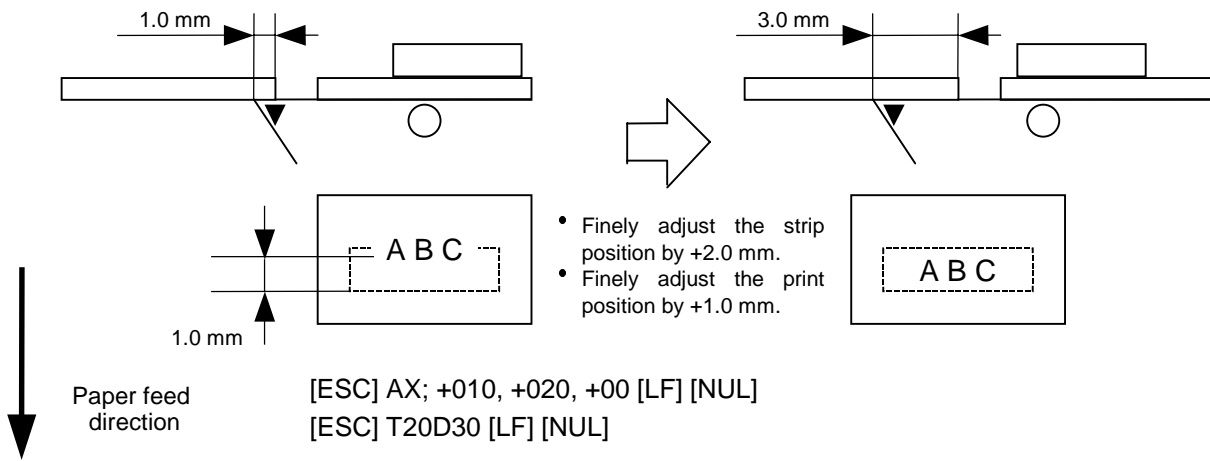

6.3.3 PRINT DENSITY FINE ADJUST COMMAND

[ESC] AY

Function	Adjusts the automatically set print density.
Format	[ESC] AY; abb, c [LF] [NUL]
Term	a: Indicates whether to increase or decrease the density. +: Increase (darker) -: Decrease (lighter) bb: Print density fine adjustment value 00 to 10 (in units of 1 step) c: Indicates the mode for fine adjustment, thermal transfer or direct thermal. 1: Direct thermal
Explanation	(1) The print density fine adjustment is performed by adjusting the time that voltage is applied to the thermal head. (2) If the print density fine adjustment value has been set in system mode (key operation on the printer), the fine adjustment value will be the sum of the fine adjustment by this command and the fine adjustment in system mode. The max. fine adjustment values for thermal transfer/direct thermal print modes are each ± 10 . (3) The fine adjustment values in thermal transfer print mode and direct thermal print mode can be set independently. (4) The Print Density Fine Adjust Command is protected in memory (even if the power is turned off). (5) The fine adjustment value for both the fine adjust command and the system mode fine adjustment is 00 at shipment from the factory.
Notes	Even if the print density is set to the value of +08 to +10, it will be automatically converted to +07 in order to protect the thermal head.
Examples	To set the density in thermal transfer print mode to -2. [ESC] AY; -02, 0 [LF] [NUL] To set the density in direct thermal print mode to +3. [ESC] AY; +03, 1 [LF] [NUL]

6.3.4 IMAGE BUFFER CLEAR COMMAND

[ESC] C

Function	Clears the image buffer for drawing characters, lines, bar codes, and graphics.
Format	[ESC] C [LF] [NUL]
Explanation	<ol style="list-style-type: none">(1) After changing the label size, the image buffer must be cleared.(2) The increment/decrement designation (described later) is valid until the Image Buffer Clear Command is transmitted.(3) The link field designation (described later) is effective until the Image Buffer Clear Command is sent.
Examples	[ESC] D0508, 0760, 0468 [LF] [NUL] [ESC] T20C51 [LF] [NUL] [ESC] C [LF] [NUL] [ESC] RC000; ABC [LF] [NUL] [ESC] RC001; DEF [LF] [NUL] [ESC] XS; I, 0001, 0002C3000 [LF] [NUL]

6.3.5 CLEAR AREA COMMAND

[ESC] XR

Function	Clears the designated area or reverses the white/black dot pattern in the designated area in the drawing area.
Format	[ESC] XR; aaaa, bbbb, cccc, dddd, e [LF] [NUL]
Term	<p>aaaa: Designated area start point X-coordinate Fixed as 4 digits (in 0.1 mm units)</p> <p>bbbb: Designated area start point Y-coordinate 4 or 5 digits (in 0.1 mm units)</p> <p>cccc: Designated area end point X-coordinate Fixed as 4 digits (in 0.1 mm units)</p> <p>dddd: Designated area end point Y-coordinate 4 or 5 digits (in 0.1 mm units)</p> <p>e: Type of clear A: Clears the contents in the designated area to zeros. B: Reverses the white/black dot pattern in the designated area.</p>

Explanation

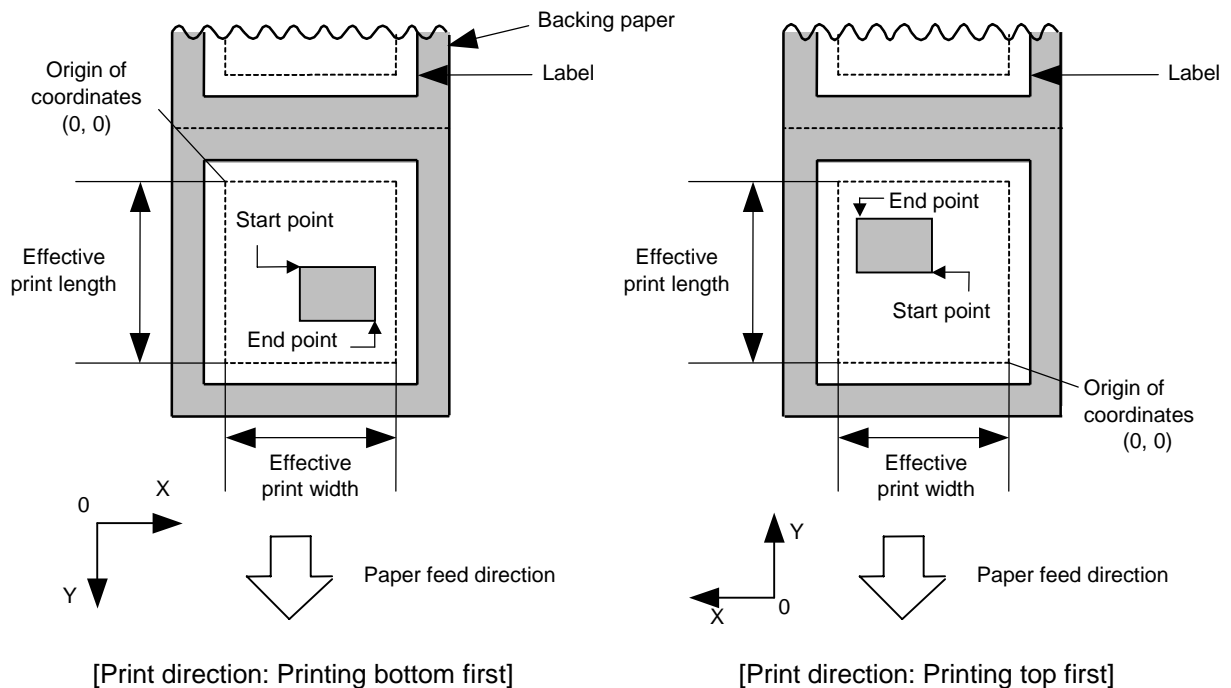

Notes	<ol style="list-style-type: none"> (1) The result is the same even if the start and end point coordinates are reversed. (2) The result is the same even if the start and end point coordinates are set to an upper right and a lower left points, respectively. (3) The start and end coordinates of the designated area must be set within the effective print area set by the Label Size Set Command ([ESC] D).
-------	--

[Effective print area]

[mm]

Item		Model	B-SV4D		
		Method	Batch	Strip	Cutter
Effective print width		Min.	13.0		
		Max.	108 ± 0.2		
Effective print length	Label	Min.	8.0	23.4	13.0
		Max.	607.6		
	Tag	Min.	8.0	-	13.0
		Max.	607.6	-	607.6

Examples

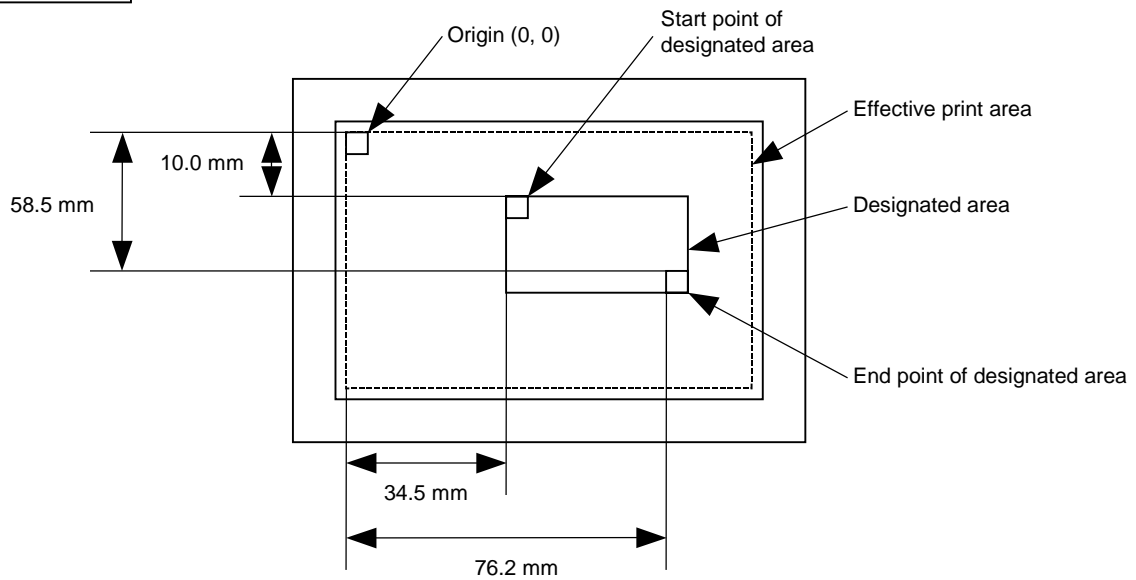

[ESC] XR; 0345, 0100, 0762, 0585, A [LF] [NUL]
 [ESC] RC000; ABC [LF] [NUL]
 [ESC] RC001; DEF [LF] [NUL]
 [ESC] XS; I, 0001, 0002C3000 [LF] [NUL]

6.3.6 LINE FORMAT COMMAND

[ESC] LC

Function	Sets the line format and draws the line.
Format	[ESC] LC; aaaa, bbbb, cccc, dddd, e, f (, ggg) [LF] [NUL]
Term	<p>aaaa: Start point X-coordinate Fixed as 4 digits (in 0.1 mm units)</p> <p>bbbb: Start point Y-coordinate 4 or 5 digits (in 0.1 mm units)</p> <p>cccc: End point X-coordinate Fixed as 4 digits (in 0.1 mm units)</p> <p>dddd: End point Y-coordinate 4 or 5 digits (in 0.1 mm units)</p> <p>e: Type of line 0: Line (horizontal, vertical, slant) 1: Rectangle</p> <p>f: No. of line width dots 1 to 9 (in 0.1 mm units)</p> <p>ggg: Radius of rounded corners of rectangles (Omissible. If omitted, the chamfering process for rectangle corners is not performed.) Fixed as 3 digits (in 0.1 mm units)</p>

Explanation

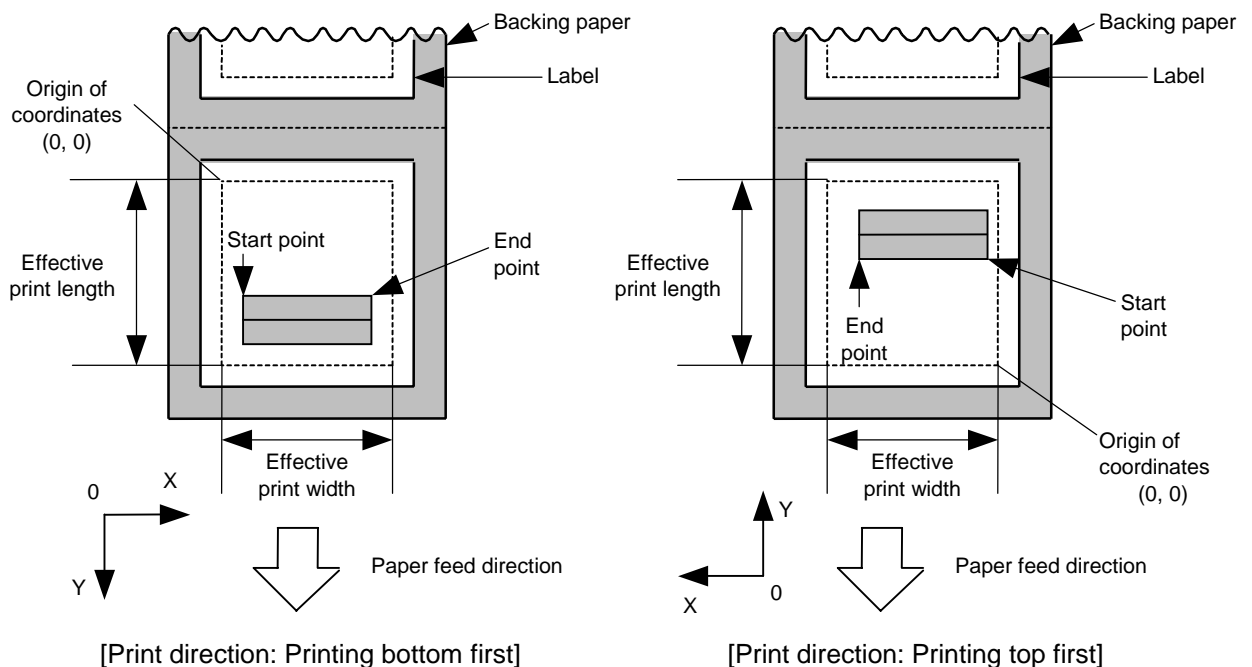

[Line]

- (1) Horizontal line (In the case of $|Y_2 - Y_1| = 0$)

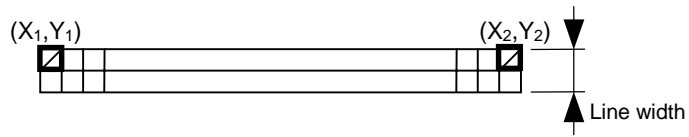

- (2) Vertical line (In the case of $|X_2 - X_1| = 0$)

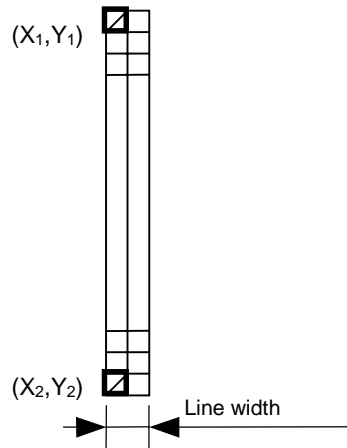

- (3) Slant line A ($|X_2 - X_1| \leq |Y_2 - Y_1|$)

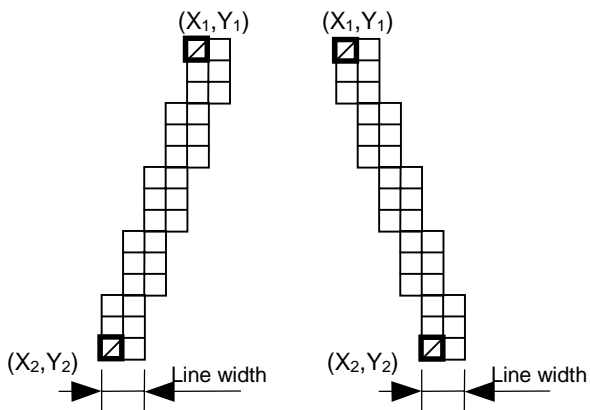

- (4) Slant line B ($|X_2 - X_1| > |Y_2 - Y_1|$)

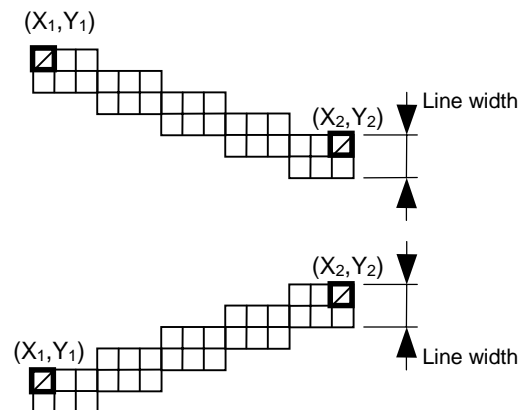

[Rectangle]

(1) Radius of rounded corners = 000 or parameter omitted

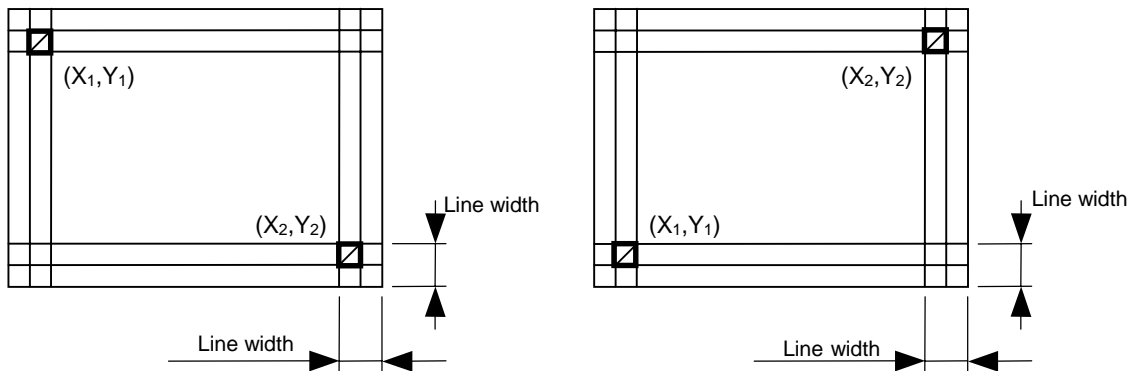

(2) Radius of rounded corners ≠ 000

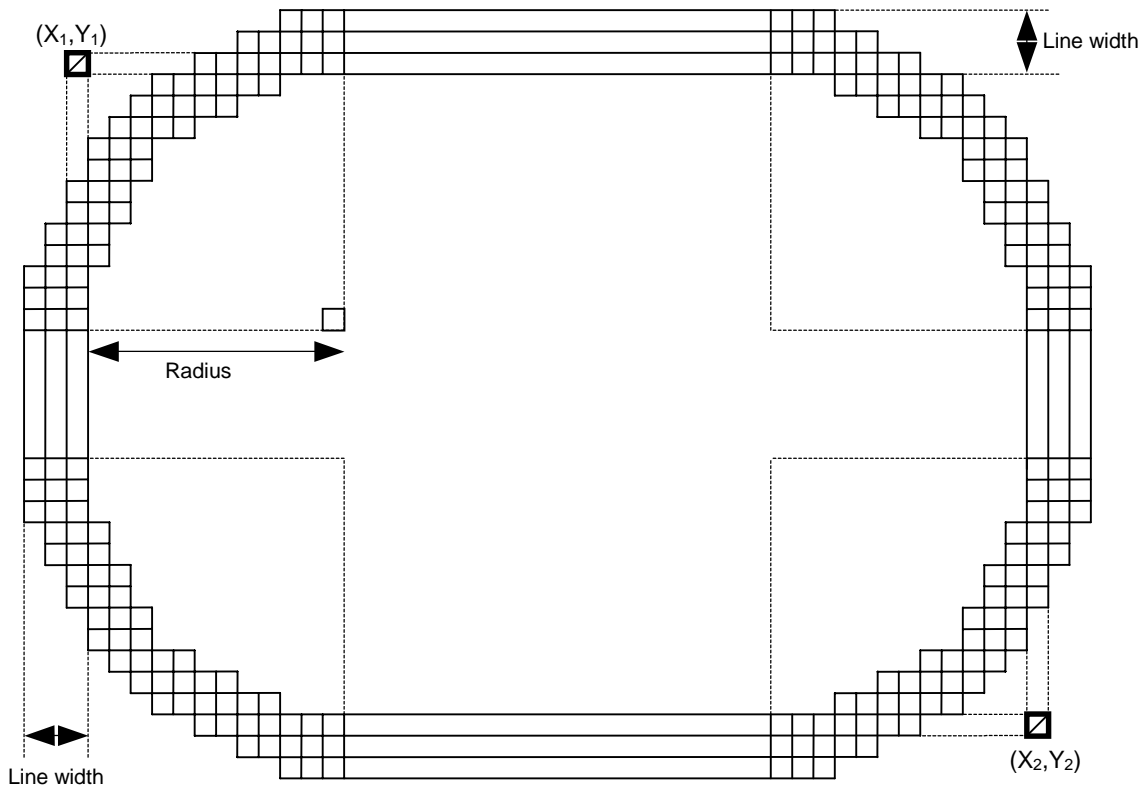

Notes

- (1) In line designation, a horizontal line, vertical line, or slant line A/B is drawn according to the start and end point coordinates.
- (2) The result is the same even if the start and end point coordinates are reversed.
- (3) The start and end point coordinates must be set so that the result of line drawing will be within the effective print area set by the Label Size Set Command ([ESC] D).

- (4) Programming the radius of the rounded corner is effective only when the type of line is 1 (rectangle). When the type of line is 0, designation of the radius is ignored.
When the type of line is 1, and the radius of the rounded corner is 000 or omitted, a rectangle is printed.

- (5) A circle is assumed when:

$$\frac{|X_2 - X_1|}{2} = \frac{|Y_2 - Y_1|}{2} \leq [\text{Radius of rounded corners}]$$

[Effective print area] [mm]

Item		Model	B-SV4D		
Item		Method	Batch	Strip	Cutter
Effective print width		Min.	13.0		
		Max.	108 ± 0.2		
Effective print length	Label	Min.	8.0	23.4	13.0
		Max.	607.6		
	Tag	Min.	8.0	-	13.0
		Max.	607.6	-	607.6

Examples

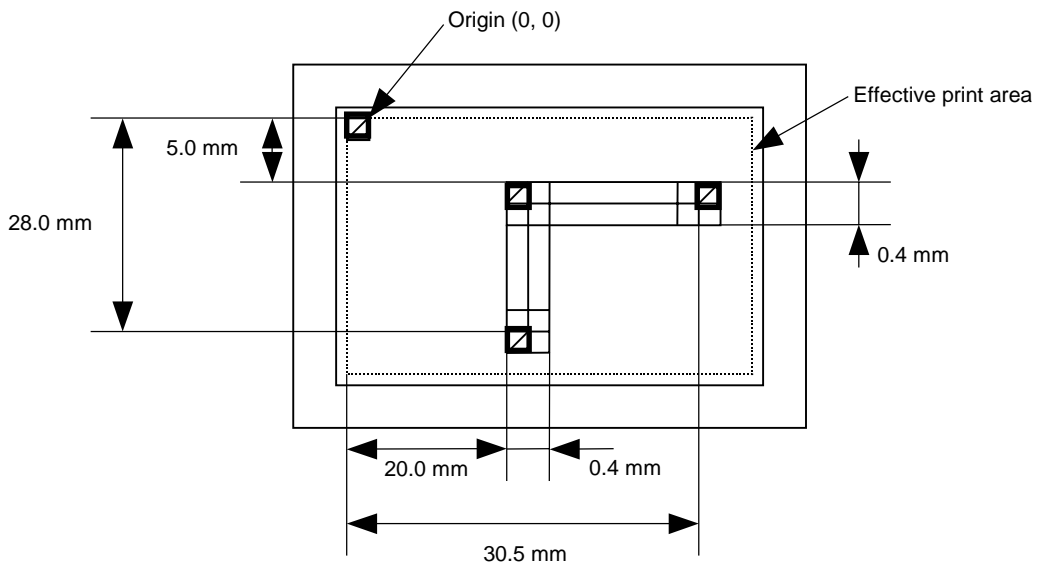

```
[ESC] C [LF] [NUL]
[ESC] LC; 0200, 0350, 0305, 0050, 0, 4 [LF] [NUL]
[ESC] LC; 0200, 0050, 0200, 0280, 0, 4 [LF] [NUL]
[ESC] XS; I, 0001, 0002C3000 [LF] [NUL]
```

6.3.7 BIT MAP FONT FORMAT COMMAND

[ESC] PC

Function	Sets the format indicating on the label at which the bit map font is to be printed and how it is to be printed.																														
Format	<p>① [ESC] PCaaa; bbbb, cccc, d, e, ff (, gh), ii, j (, Jkkll) (, Mm) (, noooooooooo) (, Zpp) (, Pq) (=rrr-----rrr) [LF] [NUL]</p> <p>② [ESC] PCaaa; bbbb, cccc, d, e, ff (, gh), ii, j (, Jkkll) (, Mm) (, noooooooooo) (, Zpp) (, Pq) (; ss₁, ss₂, ss₃, -----, ss₂₀) [LF] [NUL]</p>																														
Term	<p>aaa: Character string number 000 to 199 (two digits, 00 to 99, also acceptable)</p> <p>bbbb: Print origin of X-coordinate of character string Fixed as 4 digits (in 0.1 mm units)</p> <p>cccc: Print origin of Y-coordinate of character string 4 or 5 digits (in 0.1 mm units)</p> <p>d: Character horizontal magnification 1 to 9 (in magnifications) * Two digit designation enables magnifications in 0.5 units (05 ~ 95: 0.5 to 9.5 magnifications). The magnification can be designated in 0.1 units between 0.5 to 1. (06 ~ 09: 0.6 to 0.9 magnifications).</p> <div style="margin-left: 40px;"> <table border="0"> <tr> <td style="text-align: right;">d d</td> <td></td> </tr> <tr> <td style="border-left: 1px solid black; border-bottom: 1px solid black; padding-left: 5px;"></td> <td style="padding-left: 5px;">Designation in 0.5 magnification units : 0 or 5 (5 to 9, up to 1 magnification)</td> </tr> <tr> <td style="border-left: 1px solid black; border-bottom: 1px solid black; padding-left: 5px;"></td> <td style="padding-left: 5px;">Designation in magnifications : 0 to 9</td> </tr> </table> </div> <p>e: Character vertical magnification 1 to 9 (in magnifications) * Two digit designation enables magnifications in 0.5 units (05 ~ 95: 0.5 to 9.5 magnifications). The magnification can be designated in 0.1 units between 0.5 to 1. (06 ~ 09: 0.6 to 0.9 magnifications).</p> <div style="margin-left: 40px;"> <table border="0"> <tr> <td style="text-align: right;">e e</td> <td></td> </tr> <tr> <td style="border-left: 1px solid black; border-bottom: 1px solid black; padding-left: 5px;"></td> <td style="padding-left: 5px;">Designation in 0.5 magnification units : 0 or 5 (5 to 9, up to 1 magnification)</td> </tr> <tr> <td style="border-left: 1px solid black; border-bottom: 1px solid black; padding-left: 5px;"></td> <td style="padding-left: 5px;">Designation in magnifications : 0 to 9</td> </tr> </table> </div> <p>ff: Type of font</p> <table border="0" style="margin-left: 40px;"> <tr> <td>E: Times Roman</td> <td>(Bold)</td> <td>14 point</td> </tr> <tr> <td>J: Helvetica</td> <td>(Bold)</td> <td>12 point</td> </tr> <tr> <td>M: Presentation</td> <td>(Bold)</td> <td>18 point</td> </tr> <tr> <td>N: Letter Gothic</td> <td>(Medium)</td> <td>9.5 point</td> </tr> <tr> <td>O: Prestige Elite</td> <td>(Medium)</td> <td>7 point</td> </tr> <tr> <td>Q: Courier</td> <td>(Medium)</td> <td>10 point</td> </tr> </table> <p style="margin-left: 40px;">{ U: Kanji (16×16 dots)/Writable character (16×16 dots) (Square Gothic) V: Kanji (24×24 dots)/Writable character (24×24 dots) (Square Gothic) W: Kanji (32×32 dots)/Writable character (32×32 dots) (Square Gothic) X: Kanji (48×48 dots)/Writable character (48×48 dots) (Square Gothic)</p>	d d			Designation in 0.5 magnification units : 0 or 5 (5 to 9, up to 1 magnification)		Designation in magnifications : 0 to 9	e e			Designation in 0.5 magnification units : 0 or 5 (5 to 9, up to 1 magnification)		Designation in magnifications : 0 to 9	E: Times Roman	(Bold)	14 point	J: Helvetica	(Bold)	12 point	M: Presentation	(Bold)	18 point	N: Letter Gothic	(Medium)	9.5 point	O: Prestige Elite	(Medium)	7 point	Q: Courier	(Medium)	10 point
d d																															
	Designation in 0.5 magnification units : 0 or 5 (5 to 9, up to 1 magnification)																														
	Designation in magnifications : 0 to 9																														
e e																															
	Designation in 0.5 magnification units : 0 or 5 (5 to 9, up to 1 magnification)																														
	Designation in magnifications : 0 to 9																														
E: Times Roman	(Bold)	14 point																													
J: Helvetica	(Bold)	12 point																													
M: Presentation	(Bold)	18 point																													
N: Letter Gothic	(Medium)	9.5 point																													
O: Prestige Elite	(Medium)	7 point																													
Q: Courier	(Medium)	10 point																													

For the JA model only

- 01 (a): Writable character 1 (1×1 dot to 720×720 dots)
to
- 40 (a): Writable character 40 (1×1 dot to 720×720 dots)
- 51 (a): 2-byte code set writable character 1 (1×1 dot to 720×720 dots)
to
- 55 (a): 2-byte code set writable character 5 (1×1 dot to 720×720 dots)
- a: Drive
(Omissible. If omitted, flash ROM on the CPU board is selected.)
0: Flash ROM on the CPU board
1:Flash ROM on the memory board (Option)
2:Flash ROM on the memory board (Option)
- * The following fonts are proportional: E, J
- ghh: Fine adjustment of character-to-character space
(Omissible. If omitted, space is adjusted according to the designated font.)
g: Designates whether to increase or decrease the character-to-character space.
+: Increase
-: Decrease
- hh: No. of space dots between characters
00 to 99 (in dots)
- ii: Rotational angles of a character and character string
- | | | |
|-----|--------------|---------------------|
| 00: | 0° (char.) | 0° (char.-string) |
| 11: | 90° (char.) | 90° (char.-string) |
| 22: | 180° (char.) | 180° (char.-string) |
| 33: | 270° (char.) | 270° (char.-string) |
- j: Character attribution
- B: Black character
- W (aabb): Reverse character
- aa: No. of dots from the character string to the end of the black background in the horizontal direction
- bb: No. of dots from the character string to the end of the black background in the vertical direction
- aa: 01 to 99 (in units of dots)
- bb: 01 to 99 (in units of dots)
- F (aabb): Boxed character
- aa: No. of dots from the character string area to the box in the horizontal direction
- bb: No. of dots from the character string area to the box in the vertical direction
- aa: 01 to 99 (in units of dots)
- bb: 01 to 99 (in units of dots)
- C (aa): Stroked out character
- aa: No. of dots from the character string area to the end of the stroke
- aa: 01 to 99 (in units of dots)
- * Descriptions in parentheses are omissible.
(If omitted, it is character magnification (the larger one of horizontal or vertical magnifications) × 6 dots.)

Jkkl: Bold character designation
(Omissible. If omitted, this process is not performed.)

kk: No. of horizontal shift dots
00 to 16 (in dots)

ll: No. of vertical shift dots
00 to 16 (in dots)

Mm: Type of check digits to be attached.
(Omissible. If omitted, this process is not performed)

m: Type of check digit
0: Modulus 10 (Draws data and check digit)
1: Modulus 43 (Draws data and check digit)
2: DBP Modulus 10 (Draws data and check digit)

nooooooooo: Increment and decrement
(Omissible. If omitted, incrementing/decrementing is not performed.)
n: Designates whether to increment or decrement.
+: Increment
-: Decrement

oooooooooo: Skip value
0000000000 to 9999999999

Zpp: Zero suppression
(Omissible. If omitted, the zero suppression process is not performed.)
pp: No. of zeros to be suppressed
00 to 20

Pq: Alignment (Omissible, If omitted, the alignment is set to left.)
q: Designates the character position
1: Left
2: Center
3: Right
4aaaa: Equal space
aaaa: X direction of character string area
0050 to 1040 (in 0.1 mm units)
bbb: Line feed length
010 to 500 (in 1 mm units)
cc: Number of lines
01 to 99

rrr-----rrr: Data string to be printed (Omissible)
Max. 255 digits

ss₁, ss₂, ss₃, -----, ss₂₀: Link field No. (Omissible)
01 to 99 (1 to 99 can be also used.)
Up to 20 fields can be designated using commas.

Explanation

(1) Character string number

When drawing by the Data Command ([ESC] RC), the format designated by the character string number is selected.

(2) Print origin of coordinates

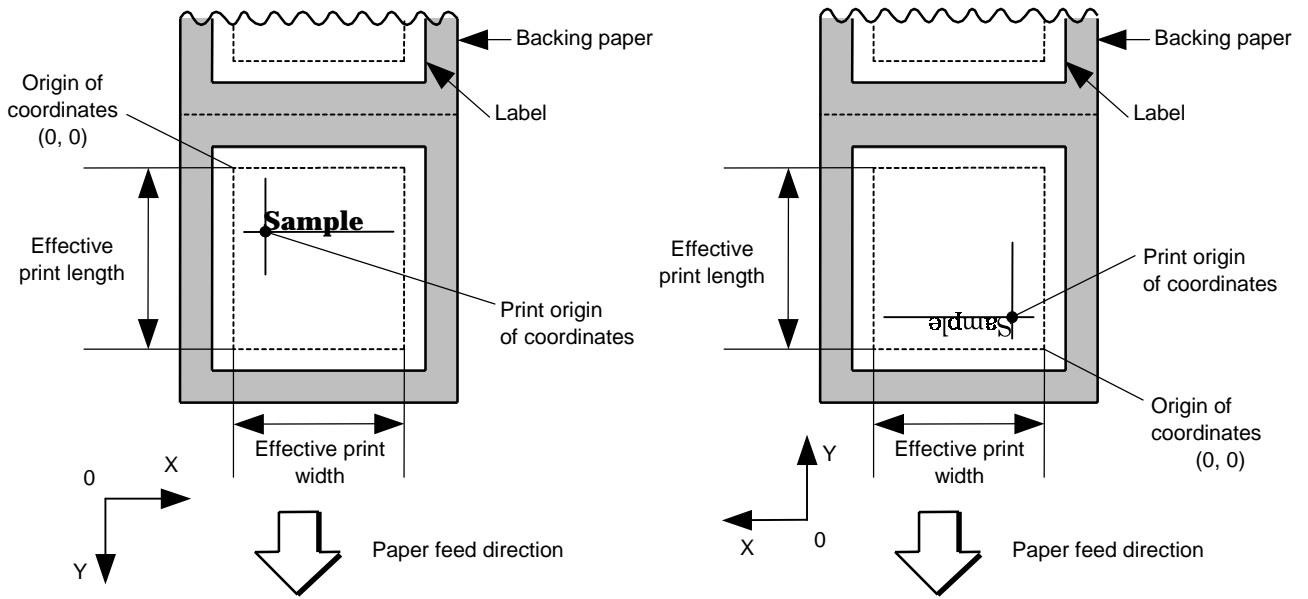

[Printing direction: Printing bottom first]

[Printing direction: Printing top first]

The print origin of coordinates must be set so that the result of character drawing will be within the effective print area set by the Label Size Set Command ([ESC] D).

[Effective print area]

[mm]

Item		Model	B-SV4D		
		Method	Batch	Strip	Cutter
Effective print width		Min.	13.0		
		Max.	108 ± 0.2		
Effective print length	Label	Min.	8.0	23.4	13.0
		Max.	607.6		
	Tag	Min.	8.0	-	13.0
		Max.	607.6	-	607.6

(3) Horizontal magnification and vertical magnification

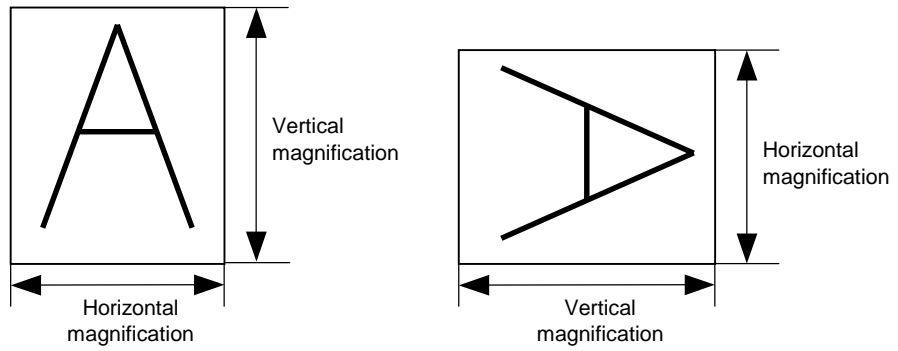

[Relationship between drawing coordinates and magnification]

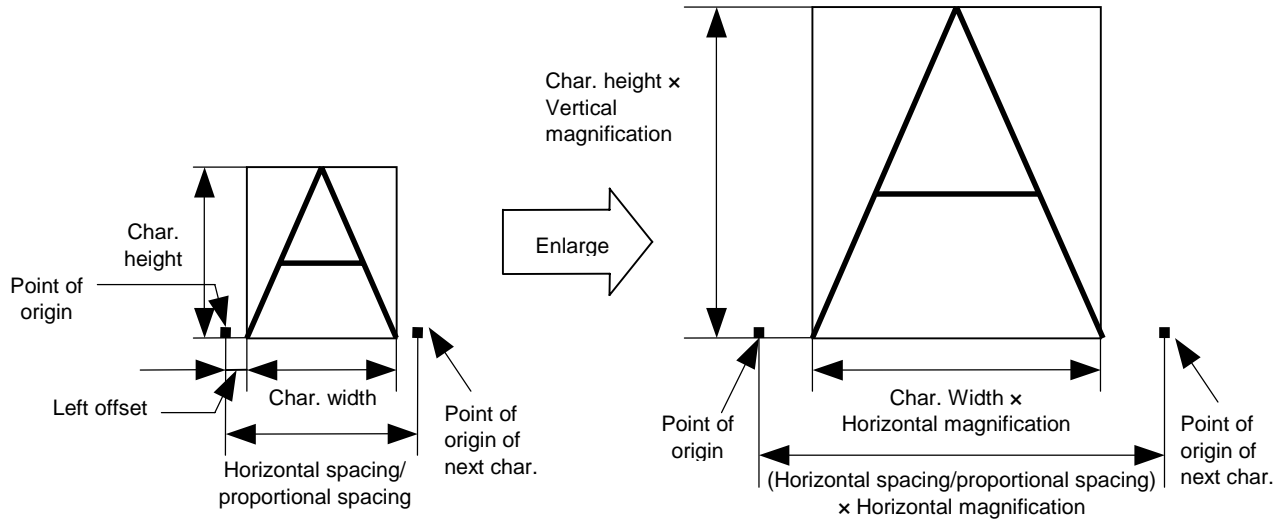

(4) Type of font

Times Roman	!"#\$%&'()*+,-./0123456789@ABCDEFGHIJabcdefghiÅÏØÆàìÆ
Helvetica	!"#\$%&'()*+,-./0123456789@ABCDEFGHIJabcdefghiÅÏØÆàìÆ
Presentation	!"#\$%&0123456789@ABCDEFABCDE
Letter Gothic	!"#\$%&'()*+,-./0123456789;=<=>?@ABCDEFGHIJKLMNOpqrstuvwxyzÅÏØÆàìÆ
Prestige Elite	!"#\$%&'()*+,-./0123456789;=<=>?@ABCDEFGHIJKLMNOpqrstuvwxyzÅÏØÆàìÆ
Courier	!"#\$%&'()*+,-./0123456789;=<=>?@ABCDEFGHIJabcdefghiÅÏØÆàìÆ

(5) Fine adjustment of character-to-character space

If no character-to-character space is specified or the number of space dots between characters is 0, drawing will take place according to the horizontal spacing/proportional spacing determined for each character. If character-to-character space is specified, drawing will take place according to the value obtained by adding the character spacing/proportional spacing to the specified value.

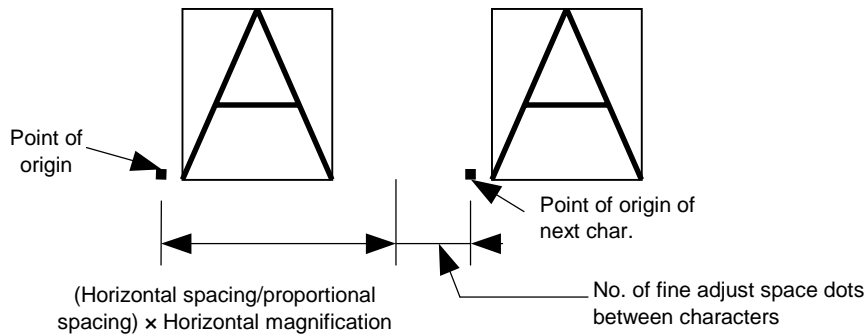

(6) Rotational angles of a character and character string

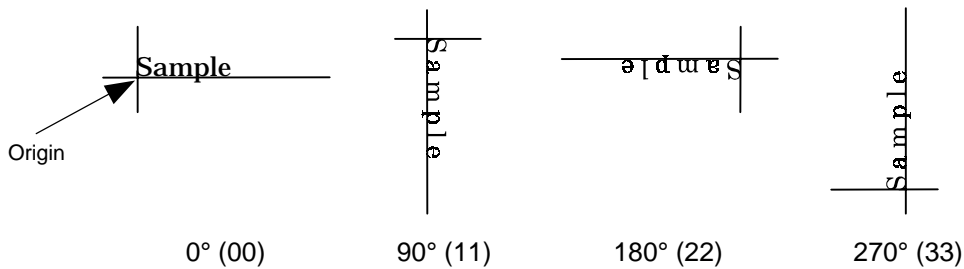

(7) Selection of character attribution

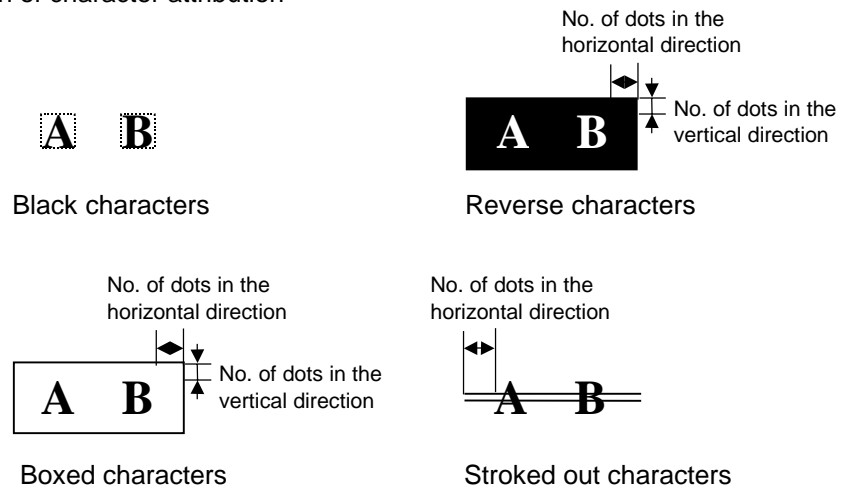

(8) Bold character designation

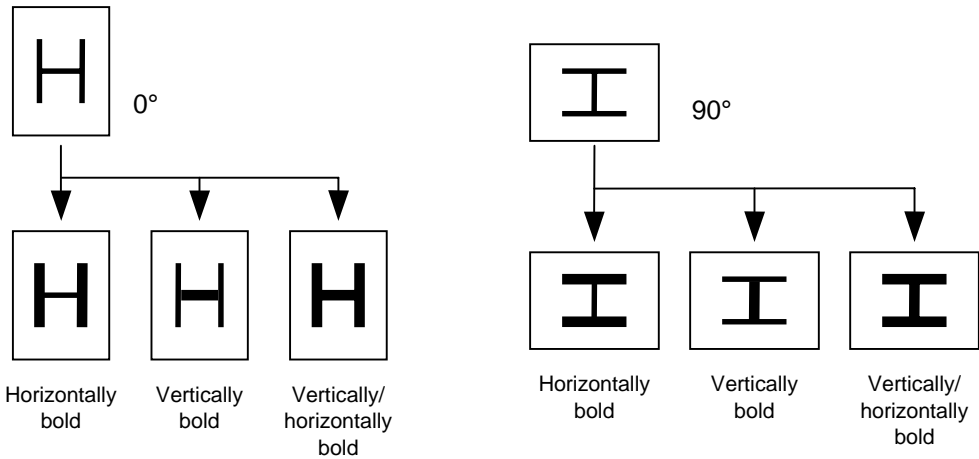

(9) Check digit to be attached

When Modulus 10 or Modulus 43 is selected, the check digit of a data row is calculated and attached to the data row for drawing.

When DBP Modulus 10 is selected, the check digit of a data row is calculated and only the check digit is drawn. When the data includes any data other than the numerals, drawing is not performed.

* DBP Modulus 10 is Modulus 10 for Deutsche Bundespost Postdienst only.

(10) Increment/decrement

Printing is performed while the data is incremented or decremented every time a label is issued. Where the data row exceeds the maximum number of digits (40), the data row will not be drawn. When the font type is 51, 52, 53, 54, or 55, the incrementing/decrementing cannot be designated. (If it is designated, it is ignored, and the printer operates as if there was no designation.)

Initial value	0000	0000	0000	0000	999999
INC/DEC	+10	+10	+10	+10	+1
Zero suppression	Not designated	5	3	0	3
1st label	0000	0000	└000	0000	999999
2nd label	0010	0010	└010	0010	└└└000
3rd label	0020	0020	└020	0020	└└└001
4th label	0030	0030	└030	0030	└└└002
5th label	0040	0040	└040	0040	└└└003

Letters and numerals for increment/decrement

For the data string, up to 40 digits (including letters, numerals, and symbols) are possible. Only the numerals are picked up and calculated for incrementing/decrementing, and then are returned to the previous position to draw the data.

Example of increment/decrement calculation

Initial value	00000	A0A0A	7A8/9	A2A0A
INC/DEC	+1	+1	+3	-3
1st label	00000	A0A0A	7A8/9	A2A0A
2nd label	00001	A0A1A	7A9/2	A1A7A
3rd label	00002	A0A2A	7A9/5	A1A4A
4th label	00003	A0A3A	7A9/8	A1A1A
5th label	00004	A0A4A	8A0/1	A0A8A

(11) Zero suppression

No. of zeros to be suppressed	0	1	2	2	3	4	5
Data	0000	0000	0000	0A12	0123	0123	0123
Print	0000	000	00	A12	123	0123	0123

The leading zero(s) in a data row is replaced by a space(s) according to the designated number of digits. However, if the number of digits to be suppressed is greater than the data row, the data row will be drawn without zero suppression. Where the data row exceeds the maximum number of digits (40), the data row will not be drawn. When the font type is 51, 52, 53, 54 or 55, zero suppression is not designated. If it is designated, it is ignored, and the printer operates as if there was no designation.

(12) Alignment

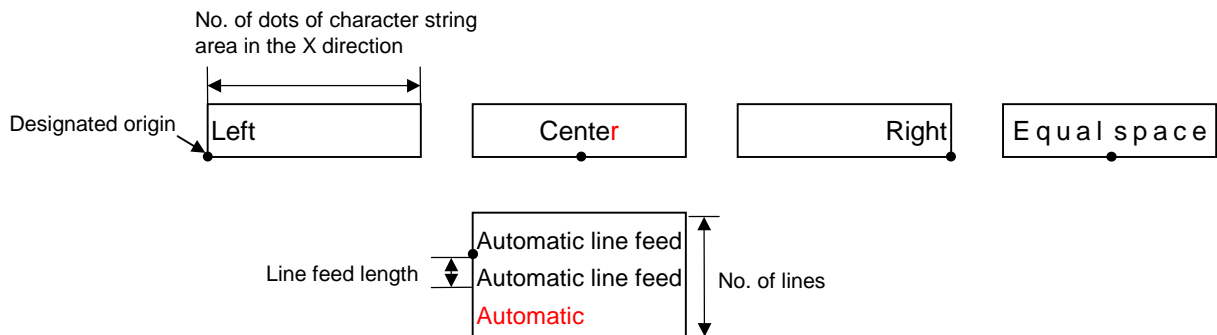

If characters are not placed on one line when equal space and automatic line feed is designated, the following steps should be performed.

Decrease the value of the character-to-character space. When characters are not placed on one line if the value is set to 0, return the value to its default, and then reduce the horizontal magnification for a character by 0.5.

If characters are still not placed on one line, repeatedly decrease the value of the character-to-character space, and then reduce the horizontal magnification. When characters are not placed on one line if the character magnification is set to 0.5 and the character-to-character space is set to 0, the field is not drawn. (The same previous field is also not drawn.)

(13) Data string to be printed

Drawing data can be programmed by designating the number of digits after the symbol “=” Up to 255 digits can be printed. If the number of digits exceeds 255, the excessive data will be discarded.

For the character code table, refer to the character code table mentioned later.

(14) Link field No.

The link field No. can be programmed by designating it after the symbol “;”. After the link field No. is designated using the Format Command, the data strings are linked by the Link Field Data Command to draw an image.

Up to 20 fields can be linked.

The following shows an example of linked fields on the two continuous labels.

[Format Command]

[ESC] PC01;..... ; 01 [LF] [NUL] : Link field No. 1 is designated.
[ESC] PC02;..... ; 03 [LF] [NUL] : Link field No. 3 is designated.
[ESC] PC03;..... ; 04 [LF] [NUL] : Link field No. 4 is designated.
[ESC] XB01; ; 03, 04 [LF] [NUL] : Link fields No. 3 and No. 4 are designated.

[ESC] PC04;..... ; 02 [LF] [NUL] : Link field No. 2 is designated.
[ESC] PC05;..... ; 03 [LF] [NUL] : Link field No. 3 is designated.
[ESC] PC06;..... ; 04 [LF] [NUL] : Link field No. 4 is designated.
[ESC] XB02; ; 03, 04 [LF] [NUL] : Link fields No. 3 and No. 4 are designated.

Designating link field No.

[Data Command]

[ESC] RC; A [LF] B [LF] ABCD [LF] 001 [LF] [NUL]
Link field No. 1 (A)
Link field No. 2 (B)
Link field No. 3 (ABCD)
Link field No. 4 (001)

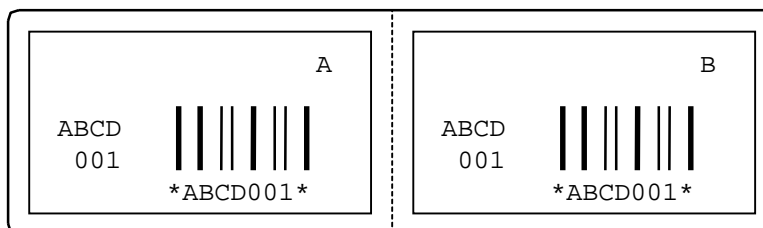

Notes

(1) The check digit attach, increment/decrement, and zero suppress processes are performed according to the following priority. If any of the conditions is improper, no drawing will take place.

[For example, the zero(s) is replaced by a space(s) as a result of zero suppression but the modulus 10 designated to be attached cannot be calculated.]

Increment/decrement > zero suppression > attachment of check digit

(2) Up to 32 fields for which incrementing/decrementing has been designated can be drawn. If the total of bit map font, outline font or bar code increment/decrement fields exceeds 32, drawing will take place without incrementing/decrementing any excessive field. The field to be incremented or decremented is incremented or decremented until the Image Buffer Clear Command ([ESC] C) is transmitted.

[Example]

- 1) Format Command (Increment character string No. 001 (+1))
- 2) Format Command (No incrementing for character string No. 002)
- 3) Format Command (Increment character string No. 003 (+2))
- 4) Image Buffer Clear Command
- 5) Data Command (Character string No. 001 "0001")
- 6) Data Command (Character string No. 002 "AB-")
- 7) Data Command (Character string No. 003 "0100")
- 8) Issue Command (2 labels)

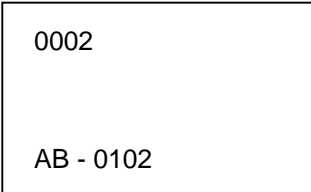
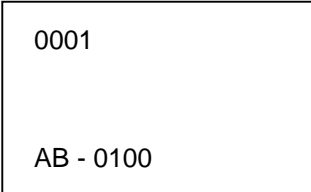

- 9) Issue Command (1 label)

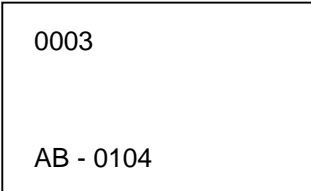

- 10) Image Buffer Clear Command
- 11) Data Command (Character string No. 002 "00000")
- 12) Issue Command (1 label)

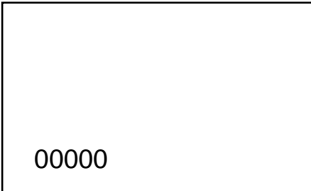

- (3) The Bit Map Font Format Command may be connected to the Outline Font Format Command when transmitted.

```
[ESC] P C001; 0100, 0150, 1, 1, A, 00, B [LF]
      C002; 0350, 0180, 1, 1, A, 00, B [LF]
      C005; 0200, 0300, 25, 2, C, +05, 00, B, +0000000001 [LF]
      V01; 0500, 0400, 0100, 0100, A, 00, B [LF] [NUL]
```

- (4) When the drawing data is changed per label issue during printing, the field of the drawing data for the previous label is automatically cleared using the character string number, then the next drawing data is printed. Therefore, the character string number which differs according to the drawing fields should be designated. Since the automatic field clear is not performed between the Clear Command ([ESC] C) and Issue Command ([ESC] XS), the fixed data may be drawn using the same character string number. In this case, the Format Command and Data Command should be sent alternately. (After the Issue Command is sent, the fields with the same character string number are automatically cleared until the Clear Command is sent.)
- (5) The link field designation is cleared by omitting the link field designation using the same character string No. and reformatting data. The link field designation can be also cleared by the Image Buffer Clear Command.
- (6) A print data string and link field No. cannot be programmed at the same time.
- (7) The same character string number cannot be programmed more than once in one format (one page).

Refer to

Bit Map Font Data Command ([ESC] RC)
Outline Font Format Command ([ESC] PV)
Bar Code Format Command ([ESC] XB)

Examples

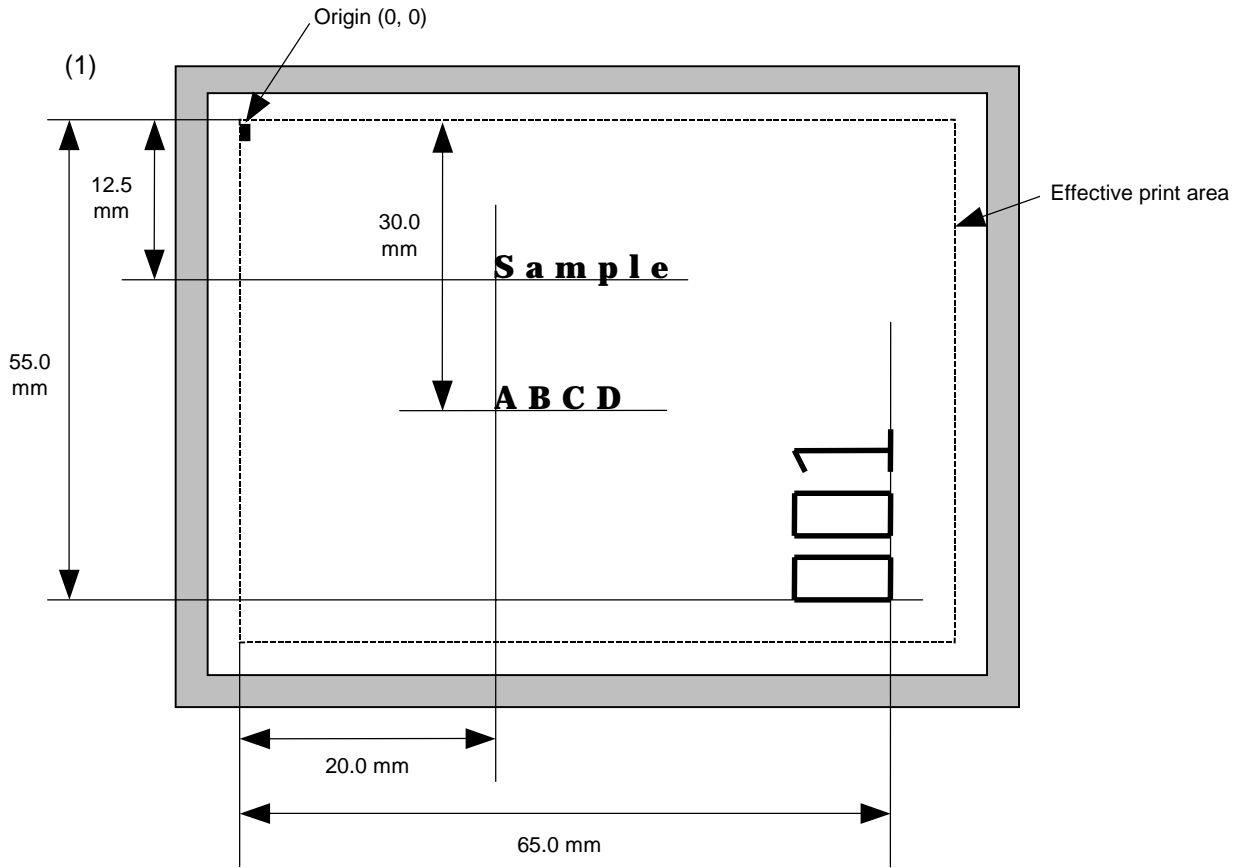

```
[ESC] C [LF] [NUL]
[ESC] PC000; 0200, 0300, 1, 1, A, 00, B=ABCD [LF] [NUL]
[ESC] PC001; 0200, 0125, 1, 1, C, 00, B [LF] [NUL]
[ESC] PC002; 0650, 0550, 2, 2, G, 33, B, +0000000001 [LF] [NUL]
[ESC] RC001; Sample [LF] [NUL]
[ESC] RC002; 001 [LF] [NUL]
[ESC] XS; I, 0002, 0002C3000 [LF] [NUL]
```

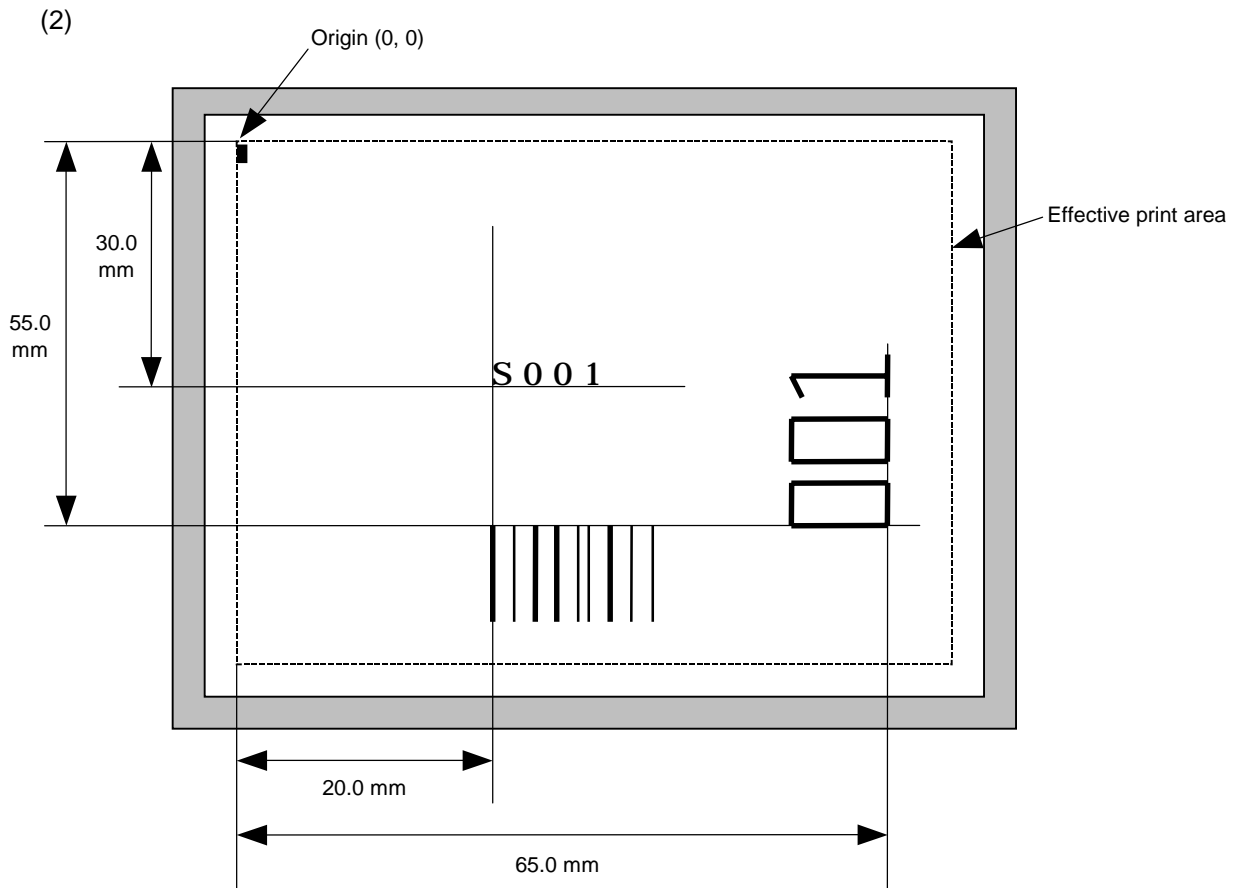

```
[ESC] C [LF] [NUL]
[ESC] PC001; 0200, 0300, 1, 1, C, 00, B; 01, 02 [LF] [NUL]
[ESC] PV01; 0650, 0550, 0200, 0150, B, 33, B; 02 [LF] [NUL]
[ESC] XB01; 0200, 0550, 3, 1, 03, 03, 08, 08, 03, 0, 0150; 01, 02 [LF] [NUL]
[ESC] RC; S [LF] 001 [LF] [NUL]
[ESC] XS; I, 0002, 0002C3000 [LF] [NUL]
```

6.3.8 OUTLINE FONT FORMAT COMMAND

[ESC] PV

Function	Sets the format to indicate the position on the label, at which the outline font is to be printed and how it is to be printed.
----------	--

⊙ Fonts other than TrueType font

Format	<p>① [ESC] PVaa; bbbb, cccc, dddd, eeee, f (, ghhh), ii, j (, Mk) (, lmmmmmmmmmm) (, Znn) (, Po) (=ppp-----ppp) [LF] [NUL]</p> <p>② [ESC] PVaa; bbbb, cccc, dddd, eeee, f (, ghhh), ii, j (, Mk) (, lmmmmmmmmmm) (, Znn) (, Po) (; qq₁, qq₂, qq₃, -----, qq₂₀) [LF] [NUL]</p>
--------	---

Term	<p>aa: Character string number 00 to 99</p> <p>bbbb: Print origin of X-coordinate of the character string Fixed as 4 digits (in 0.1 mm units)</p> <p>cccc: Print origin of Y-coordinate of the character string 4 or 5 digits (in 0.1 mm units)</p> <p>dddd: Character width 0020 to 0850 (in 0.1 mm units)</p> <p>eeee: Height of the character 0020 to 0850 (in 0.1 mm units)</p> <p>f: Type of font A: TEC FONT1 (Helvetica [bold]) B: TEC FONT1 (Helvetica [bold] proportional)</p> <p>ghhh: Fine adjustment of character-to-character space (Omissible. If omitted, space is adjusted according to the designated font.) g: Designates whether to increase or decrease the character-to-character space. +: Increase -: Decrease</p> <p>hhh: No. of space dots between characters 000 to 512 (in dots)</p> <p>ii: Rotational angles of a character and character string 00: 0° (char.) 0° (char.-string) 11: 90° (char.) 90° (char.-string) 22: 180° (char.) 180° (char.-string) 33: 270° (char.) 270° (char.-string)</p>
------	--

- j: Character attribution
- B: Black character
 - W (aabb): Reverse character
 - aa: No. of dots from the character string to the end of the black background in the horizontal direction.
 - bb: No. of dots from the character string to the end of the black background in the vertical direction.
 - aa: 01 to 99 (in units of dots)
 - bb: 01 to 99 (in units of dots)
 - F (aabb): Boxed character
 - aa: No. of dots from the character string area to the box in the horizontal direction.
 - bb: No. of dots from the character string area to the box in the vertical direction.
 - aa: 01 to 99 (in units of dots)
 - bb: 01 to 99 (in units of dots)
 - C (aa): Stroked out character
 - aa: No. of dots from the character string area to the end of the stroke
 - aa: 01 to 99 (in units of dots)
- * Descriptions in parentheses are omissible.
 (If omitted, it is character size (the larger character width or height) ÷ 8 dots.)
- Mk: Type of the check digit to be attached
 (Omissible. If omitted, the check digit is not drawn.)
- k: Type of check digit
 - 0: Modulus 10 (Draws data and check digit)
 - 1: Modulus 43 (Draws data and check digit)
 - 2: DBP Modulus 10 (Draws check digit only)
- lmmmmmmmm: Increment and decrement
 (Omissible. If omitted, incrementing/decrementing is not performed.)
- l: Designates whether to increment or decrement.
 - +: Increment
 - : Decrement
 - mmmmmmmmmm: Skip value
 0000000000 to 9999999999
- Znn: Zero suppression
 (Omissible. If omitted, the zero suppression process is not performed.)
- nn: No. of zeros to be suppressed
 00 to 20

Po: Alignment (Omissible. If omitted, the alignment is set to left.)
o: Designates the character position.
1: Left
2: Center
3: Right
4aaaa: Equal space
aaaa: X direction of character string area
0050 to 1040 (in 0.1 mm units)

ppp-----ppp: Data string to be printed (Omissible)
Max. 255 digits

qq₁, qq₂, qq₃, -----, qq₂₀: Link field No. (Omissible)
01 to 99 (1 to 99 can be also used.)
Up to 20 fields can be designated using commas.

⊙ TrueType font

Format	[ESC] PVaa; bbbb, cccc, dddd, eeee, ff, g (, hiii), jj, k (,Lmm)(=ppp ----- ppp) [LF] [NUL]
--------	---

Term	<p>aa: Character string number 00 to 99</p> <p>bbbb: Print origin of X-coordinate of the character string Fixed as 4 digits (in 0.1 mm units)</p> <p>cccc: Print origin of Y-coordinate of the character string 4 or 5 digits (in 0.1 mm units)</p> <p>dddd: Character width 0020 to 0850 (in 0.1 mm units)</p> <p>eeee: Height of the character 0020 to 0850 (in 0.1 mm units)</p> <p>ff: Type of font</p> <ul style="list-style-type: none"> 01: BalloonPExtBol (File name: Ballp_eb.ttf) 02: BlacklightD (File name: Blklt_rg.ttf) 03: BrushScrD (File name: Brush_rg.ttf) 04: CG Times (File name: Tec_cgt.ttf) 05: CG Times Bold (File name: Tec_cgtb.ttf) 06: CG Times Italic (File name: Tec_cgti.ttf) 07: Clarendon Condensed Bold (File name: Tec_clcd.ttf) 08: FlashPBol (File name: Flash_bd.ttf) 09: Garamond Kursiv Halbfett (File name: Tec_gmkh.ttf) 10: GoudyHeaP (File name: Gdyhp_rg.ttf) 11: GilliesGotDBol (File name: Gilli_bd.ttf) 12: GilliesGotLig (File name: Gilli_lt.ttf) 13: NimbusSanNovTUltLigCon (File name: Nsnct_ul.ttf) 14: Ryahd (File name: ryahd.ttf) 15: Ryahd Bold (File name: ryahdbd.ttf) 16: CG Triumvirate (File name: Trium.ttf) 17: CG Triumvirate Condensed Bold (File name: Triumcb.ttf) 18: Univers Medium (File name: Tec_uni.ttf) 19: Univers Bold (File name: Tec_unib.ttf) 20: Univers Medium Italic (File name: Tec_unii.ttf) 21: add_on TrueType font 1 (File name: addttf01.ttf) 22: add_on TrueType font 2 (File name: addttf02.ttf) 23: add_on TrueType font 3 (File name: addttf0e.ttf) 24: add_on TrueType font 4 (File name: addttf04.ttf) 25: add_on TrueType font 5 (File name: addttf05.ttf) <p>(*1) The font types 21 to 25 are the fonts that a user adds. These fonts can be used by specifying “addttf01.ttf” to “addttf05.ttf” for the file names and installing these in the memory board.</p> <p>(*2) For the fonts stored in flash ROM on the CPU board, parameter “ff” for the type of font corresponds to the font type according to the setting made when fonts are stored.</p>
------	--

- g: Drive
Indicates where the TrueType font files are stored.
- 0: Flash ROM on the CPU board
 - 1: Flash ROM on the memory board (Option)
 - 2: Flash ROM on the memory board (Option)
- hiii: Fine adjustment of character-to-character space
(Omissible. If omitted, space is adjusted according to the designated font.)
- h: Designates whether to increase or decrease the character-to-character space.
 - +: Increase
 - : Decrease
 - iii: No. of space dots between characters
000 to 512 (in dots)
- jj: Rotational angles of a character and character string
- | | | | | |
|-----|--------------|---|---------------------|-----------------------|
| 00: | 0° (char.) |) | 0° (char.-string) | (Reserved for future) |
| 11: | 90° (char.) | | 90° (char.-string) | |
| 22: | 180° (char.) | | 180° (char.-string) | |
| 33: | 270° (char.) | | 270° (char.-string) | |
- k: Character attribution
B: Black character
- Lmm: True Type font size (Omissible)
Points (1/72 inch per point)
- ppp-----ppp: Data string to be printed (Omissible)
Max. 255 digits

* TrueType fonts are not included in the standard character generator data. Therefore, they must be installed in flash ROM on the CPU board, or the memory board. For installation of TrueType font and details, refer to the TrueType Font Specification (TAA-1184).

* If Arabic is selected as the character code, letters are written from right to left.

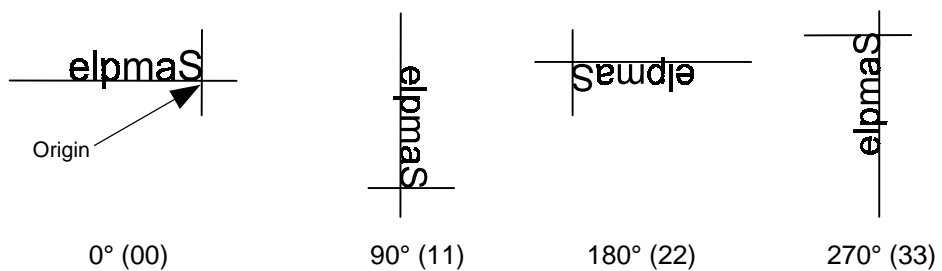

Explanation

(1) Character string number

When drawing by the Data Command ([ESC] RV), the format designated by the character string number is selected.

(2) Print origin of coordinates

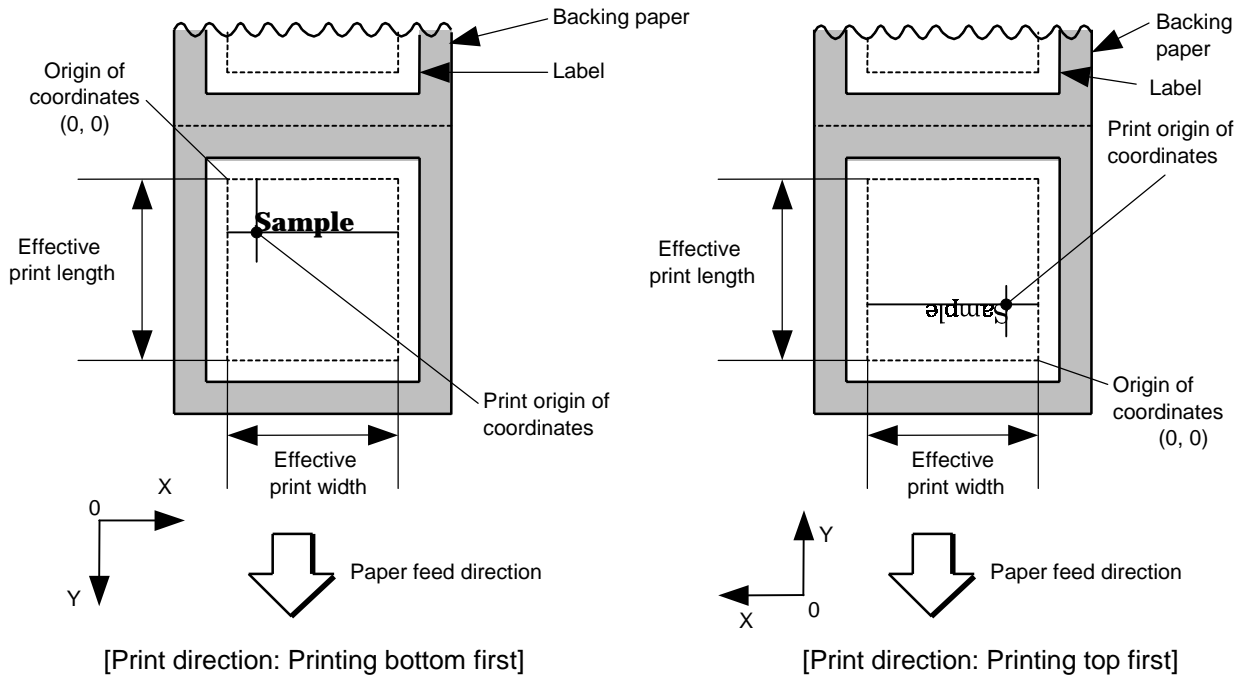

- The print origin of coordinates must be set so that the result of character drawing will be within the effective print area set by the Label Size Set Command ([ESC] D).

(3) True Type Font Size

To designate the font size and the unit is 1/72 inch per point.

[Effective print area]

[mm]

Item		Model	B-SV4D		
		Method	Batch	Strip	Cutter
Effective print width		Min.	13.0		
		Max.	108 ± 0.2		
Effective print length	Label	Min.	8.0	23.4	13.0
		Max.	607.6		
	Tag	Min.	8.0	-	13.0
		Max.	607.6	-	607.6

(4) Character width and character height

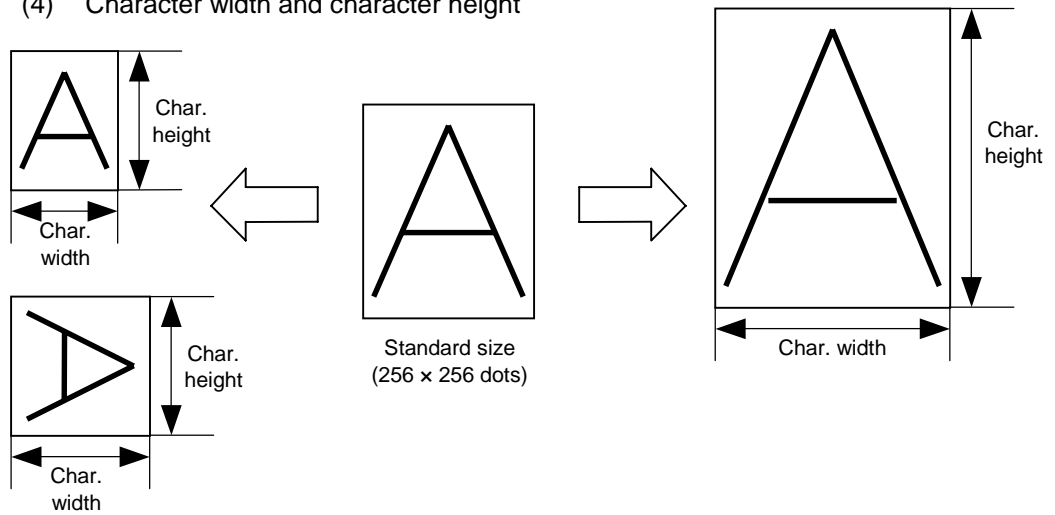

(5) Fine adjustment of character-to-character space

If no character-to-character space is specified or the number of space dots between characters is 0, drawing will take place according to the horizontal spacing/proportional spacing determined for each character. If character-to-character space is specified, drawing will take place according to the value obtained by adding the character spacing/proportional spacing to the specified value. When equal space is selected for the alignment, the character-to-character space setting is invalid. (The horizontal spacing/proportional spacing are increased or decreased depending on the character size.)

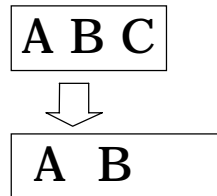

(6) Rotational angles of a character and character string

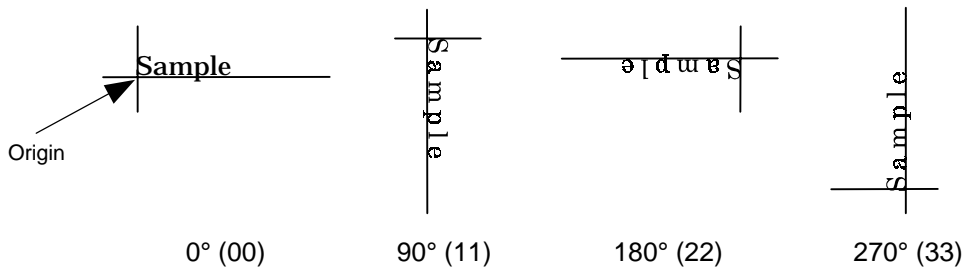

(7) Selection of character attribution

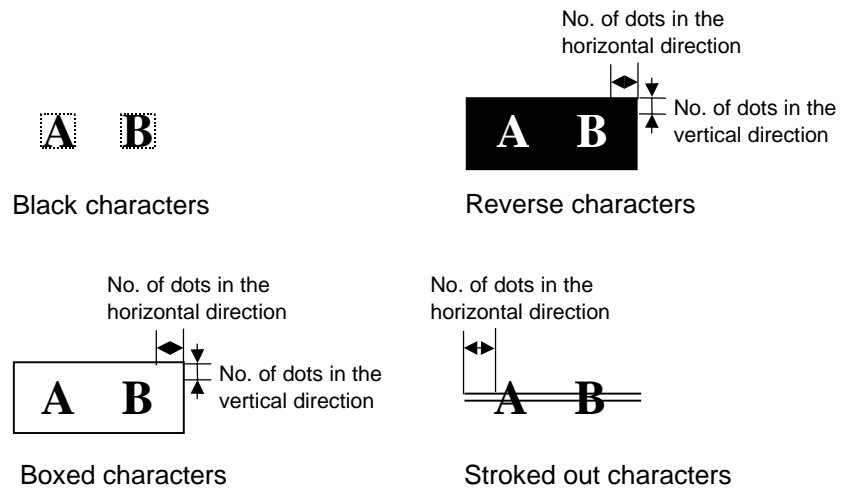

(8) Increment/decrement

Printing is performed while the data is incremented or decremented each time a label is issued. Where the data row exceeds the maximum number of digits (40), the data row will not be drawn.

Initial value	0000	0000	0000	0000	999999
INC/DEC	+10	+10	+10	+10	+1
Zero suppression	Not designated	5	3	0	3
1st label	0000	0000	└000	0000	999999
2nd label	0010	0010	└010	0010	└└└000
3rd label	0020	0020	└020	0020	└└└001
4th label	0030	0030	└030	0030	└└└002
5th label	0040	0040	└040	0040	└└└003

Letters and numerals for increment/decrement

For the data string, up to 40 digits (including letters, numerals and symbols) are possible. Only the numerals are picked up and calculated for incrementing/decrementing, and then are returned to the previous position to draw the data.

Example of increment/decrement calculation

Initial value	00000	A0A0A	7A8/9	A2A0A
INC/DEC	+1	+1	+3	-3
1st label	00000	A0A0A	7A8/9	A2A0A
2nd label	00001	A0A1A	7A9/2	A1A7A
3rd label	00002	A0A2A	7A9/5	A1A4A
4th label	00003	A0A3A	7A9/8	A1A1A
5th label	00004	A0A4A	8A0/1	A0A8A

(9) Data string to be printed

Drawing data can be programmed by designating the number of digits after the symbol “=” Up to 255 digits can be printed. When the number of digits exceeds 255, the excessive data will be discarded.

For the character code table, refer to the character code table mentioned later.

(10) Link field No.

The link field No. can be programmed by designating it after the symbol “;.” After the link field No. is designated using the Format Command, the data strings are linked by the Link Field Data Command to draw an image.

Up to 20 fields can be linked.

The following shows an example of linked fields on the two continuous labels.

[Format Command]

[ESC] PV01; ; 01 [LF] [NUL] : Link field No. 1 is designated.
 [ESC] PV02; ; 03 [LF] [NUL] : Link field No. 3 is designated.
 [ESC] PV03; ; 04 [LF] [NUL] : Link field No. 4 is designated.
 [ESC] XB01; ; 03, 04 [LF] [NUL] : Link fields No. 3 and No. 4 are designated.

[ESC] PV04; ; 02 [LF] [NUL] : Link field No. 2 is designated.
 [ESC] PV05; ; 03 [LF] [NUL] : Link field No. 3 is designated.
 [ESC] PV06; ; 04 [LF] [NUL] : Link field No. 4 is designated.
 [ESC] XB02; ; 03, 04 [LF] [NUL] : Link fields No. 3 and No. 4 are designated.

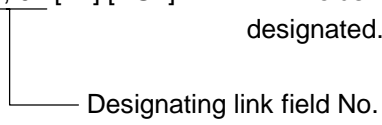

[Data Command]

[ESC] RV; A [LF] B [LF] ABCD [LF] 001 [LF] [NUL]

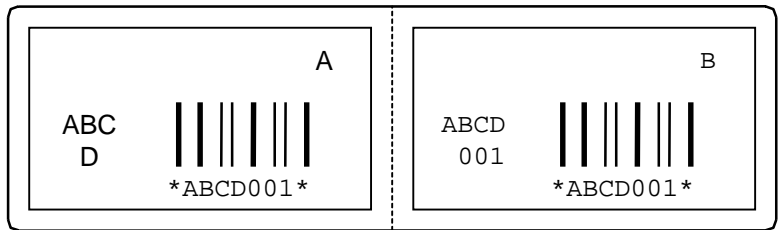
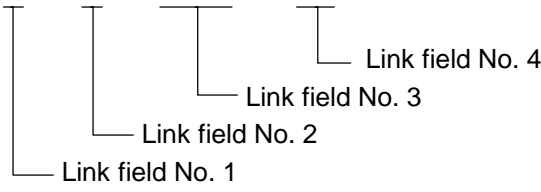

Notes

(1) The check digit attach, increment/decrement, and zero suppress processes are performed according to the following priority. If any of the conditions is improper, no drawing will take place.

[For example, the zero(s) is replaced by a space(s) as a result of zero suppression]
 [but the modulus 10 designated to be attached cannot be calculated.]

Increment/decrement > zero suppression > attachment of check digit

(2) Up to 32 fields for which incrementing/decrementing has been designated can be drawn. If the total of bit map font, outline font, or bar code increment/decrement fields exceeds 32, drawing will take place without incrementing/decrementing any excessive field. The field to be incremented or decremented is incremented or decremented until the Image Buffer Clear Command ([ESC] C) is transmitted.

[Examples]

- 1) Format Command (Increment character string No. 01 (+1))
- 2) Format Command (No incrementing for character string No. 02)
- 3) Format Command (Increment character string No. 03 (+2))
- 4) Image Buffer Clear Command
- 5) Data Command (Character string No. 01 "0001")
- 6) Data Command (Character string No. 02 "AB-")
- 7) Data Command (Character string No. 03 "0100")
- 8) Issue Command (2 labels)

0001
AB-0100

0002
AB-0102

- 9) Issue Command (1 label)

0003
AB-0104

- 10) Image Buffer Clear Command
- 11) Data Command (Character string No. 02 "00000")
- 12) Issue Command (1 label)

00000

- (3) The Outline Font Format Command may be connected to the Bit Map Font Format Command when transmitted.

[ESC] PC001; 0100, 0150, 1, 1, A, 00, B [LF]

C002; 0350, 0180, 1, 1, A, 00, B [LF]

C005; 0200, 0300, 25, 2, C, +05, 00, B, +0000000001 [LF]

V01; 0500, 0400, 0100, 0100, A, 00, B [LF] [NUL]

- (4) When the drawing data is changed per label issue during printing, the field of the drawing data for the previous label is automatically cleared using the character string number, then the next drawing data is printed. Therefore, the character string number which differs according to the drawing fields should be designated. Since the automatic field clear is not performed between the Clear Command ([ESC] C) and Issue Command ([ESC] XS), the fixed data may be drawn using the same character string number. In this case, the Format Command and Data Command should be sent alternately. (After the Issue Command is sent, the fields with the same character string number are automatically cleared until the Clear Command is sent.)
- (5) When characters overlap due to the character-to-character space fine adjustment, the outline font is not painted properly. Program the fine adjust value so that characters will not overlap. Also, when drawings such as lines or characters are on the outline font drawing position, the outline font is not painted properly. For font types A and B, the fine adjustment value should be set so that other drawings do not overlap the area in which the outline font is to be drawn. For font types C, E, F and G, the fine adjustment value should be set so that other drawings do not overlap the area for the designated character width and height.
- (6) The link field designation is cleared by omitting the link field designation using the same character string No. and reformatting data.
The link field designation can be also cleared by the Image Buffer Clear Command.
- (7) A print data string and link field No. cannot be programmed at the same time.
- (8) The same character string number cannot be programmed more than once in one format (one page).

Refer to

Outline Font Data Command ([ESC] RV)
Bit Map Font Format Command ([ESC] PC)
Bar Code Format Command ([ESC] XB)

Examples

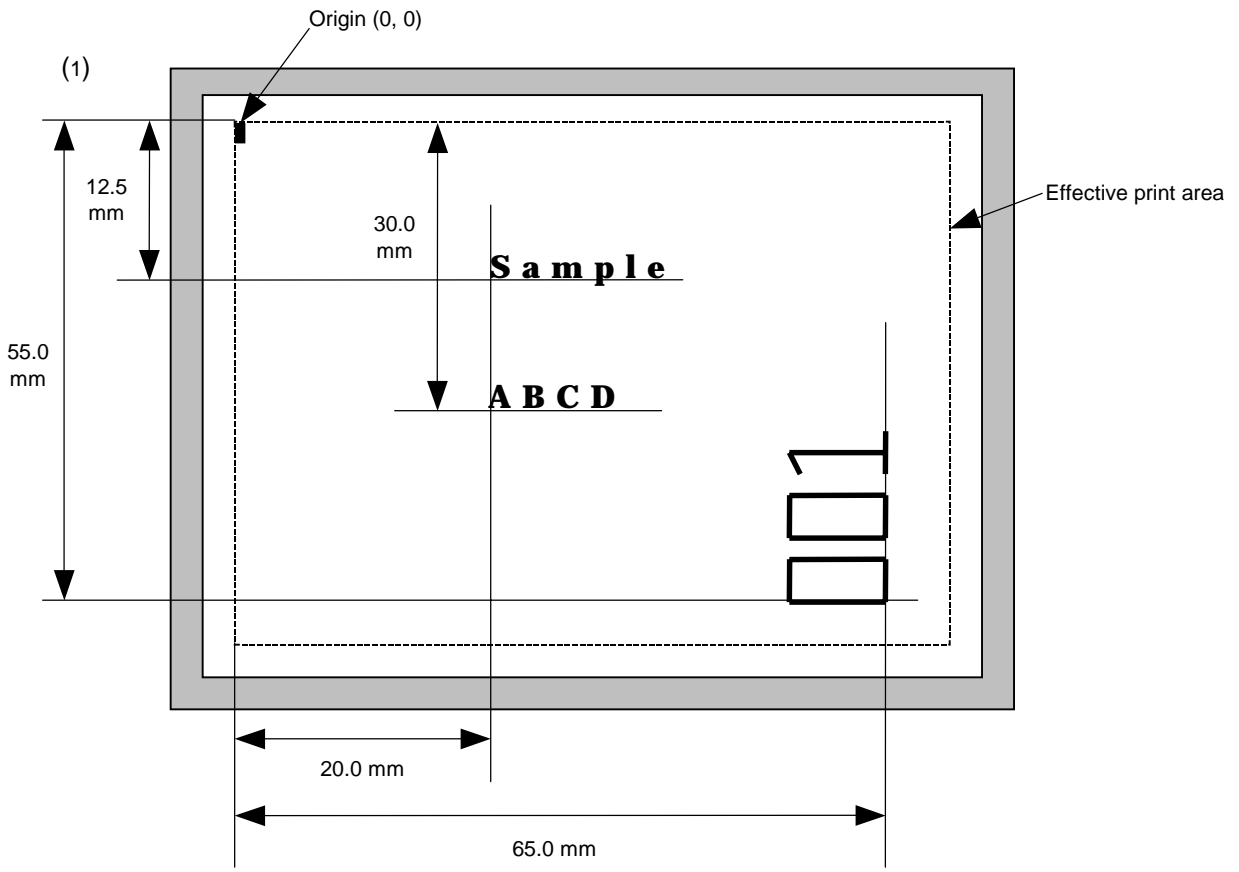

```
[ESC] C [LF] [NUL]
[ESC] PV00; 0200, 0300, 0080, 0080, B, 00, B=ABCD [LF] [NUL]
[ESC] PV01; 0200, 0125, 0100, 0100, B, 00, B [LF] [NUL]
[ESC] PV02; 0650, 0550, 0200, 0150, B, 33, B, +0000000001 [LF] [NUL]
[ESC] RV01; Sample [LF] [NUL]
[ESC] RV02; 001 [LF] [NUL]
[ESC] XS; I, 0002, 0002C3000 [LF] [NUL]
```

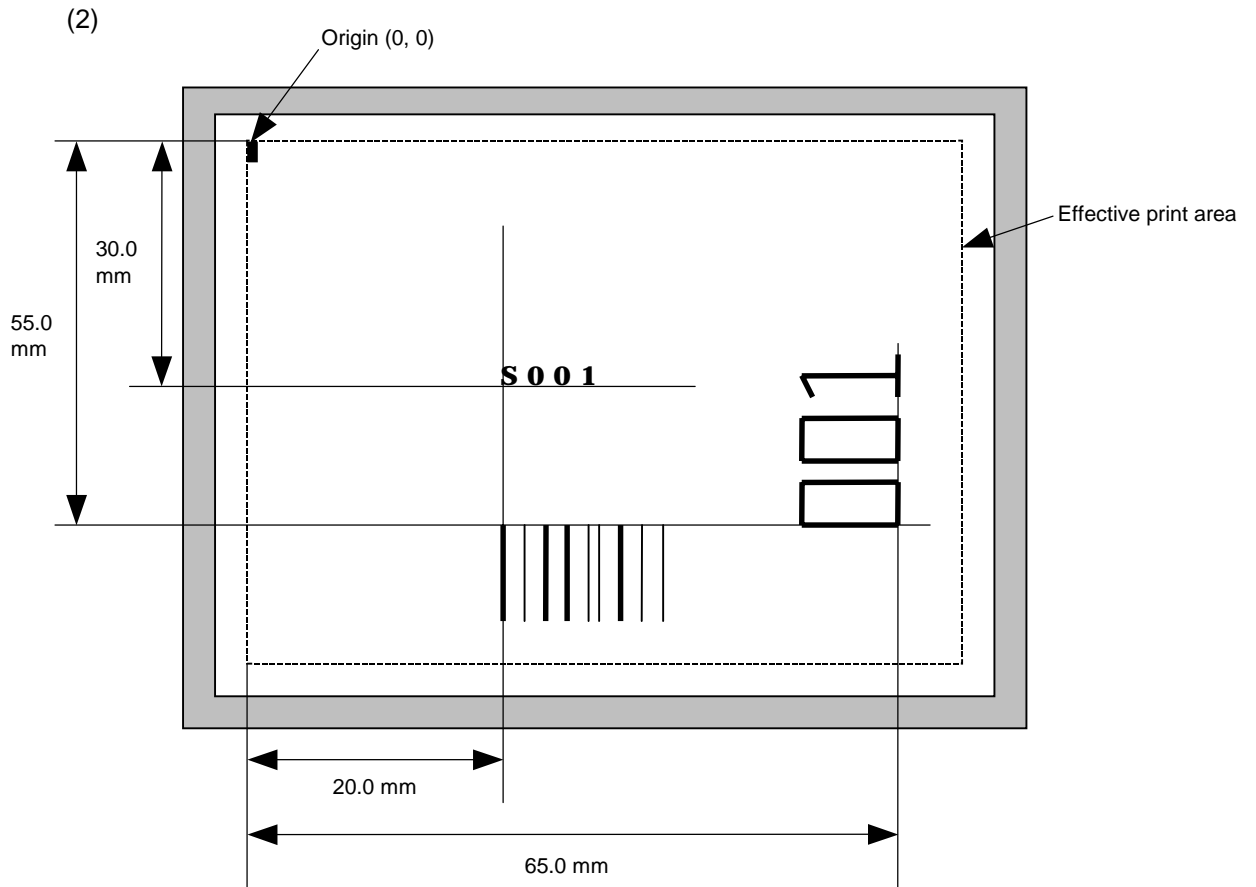

```
[ESC] C [LF] [NUL]
[ESC] PC001; 0200, 0300, 1, 1, C, 00, B; 01, 02 [LF] [NUL]
[ESC] PV01; 0650, 0550, 0200, 0150, B, 33, B; 02 [LF] [NUL]
[ESC] XB01; 0200, 0550, 3, 1, 03, 03, 08, 08, 03, 0, 0150; 01, 02 [LF] [NUL]
[ESC] RV; S [LF] 001 [LF] [NUL]
[ESC] XS; I, 0002, 0002C3000"; LF$; NUL$;
```

6.3.9 BAR CODE FORMAT COMMAND

[ESC] XB

Function	Sets the format to indicate the position on the label, at which the bar code is to be printed and how it is to be printed.
----------	--

⊙ In the case of WPC, CODE93, CODE128, UCC/EAN128, Customer bar code, POSTNET, RM4SCC, KIX CODE
(WPC is the generic name for bar codes of JAN, EAN and UPC.)

Format	① [ESC] XBaa; bbbb, cccc, d, e, ff, k, llll (, mnnnnnnnnnn, ooo, p, qq) (= sss ----- sss) [LF] [NUL] ② [ESC] XBaa; bbbb, cccc, d, e, ff, k, llll (, mnnnnnnnnnn, ooo, p, qq) (; tt ₁ , tt ₂ , tt ₃ , -----, tt ₂₀) [LF] [NUL]
--------	---

Term	aa: Bar code number 00 to 31 bbbb: Print origin of X-coordinate of the bar code Fixed as 4 digits (in 0.1 mm units) cccc: Print origin of Y-coordinate of the bar code 4 or 5 digits (in 0.1 mm units) d: Type of bar code 0: JAN8, EAN8 5: JAN13, EAN13 6: UPC-E 7: EAN13 + 2 digits 8: EAN13 + 5 digits 9: CODE128 (with auto code selection) A: CODE128 (without auto code selection) C: CODE93 G: UPC-E + 2 digits H: UPC-E + 5 digits I: EAN8 + 2 digits J: EAN8 + 5 digits K: UPC-A L: UPC-A + 2 digits M: UPC-A + 5 digits N: UCC/EAN128 R: Customer bar code (Postal code for Japan) S: Highest priority customer bar code (Postal code for Japan) U: POSTNET (Postal code for U.S) V: RM4SCC (ROYAL MAIL 4 STATE CUSTOMER CODE) (Postal code for U.K) W: KIX CODE (Postal code for Belgium)
------	--

- e: Type of check digit
- 1: Without attaching check digit
 - 2: Check digit check
 - WPC Modulus 10
 - CODE93 Modulus 47
 - CODE128 PSEUDO 103
 - 3: Check digit auto attachment (1)
 - WPC Modulus 10
 - CODE93 Modulus 47
 - CODE128 PSEUDO 103
 - UCC/EAN128 Modulus 10 + Modulus 103
 - Customer code Special check digit
 - POSTNET Special check digit
 - RM4SCC Special check digit
 - 4: Check digit auto attachment (2)
 - WPC Modulus 10 + Price C/D 4 digits
 - 5: Check digit auto attachment (3)
 - WPC Modulus 10 + Price C/D 5 digits

* For the Customer bar code, POSTNET, and RMC4SCC, only "3: Check digit auto attachment (1)" is effective.
- ff: 1-module width
01 to 15 (in dots)
- k: Rotational angle of bar code
- 0: 0°
 - 1: 90°
 - 2: 180°
 - 3: 270°
- lll: Height of the bar code
0001 to 1000 (in 0.1 mm units)
- For the Customer bar code, POSTNET, RMC4SCC, KIX CODE, the height of the long bar is specified.
- mnnnnnnnnn: Increment/decrement
(Omissible. If omitted, incrementing/decrementing is not performed.)
- m: Indicates whether to increment or decrement
- +: Increment
 - : Decrement
- nnnnnnnnnn: Skip value
0000000000 to 9999999999
- ooo: Length of WPC guard bar
(Omissible. If omitted, the guard bar is not attached.)
000 to 100 (in 0.1 mm units)
- p: Selection of print or non-print of numerals under bars
(Omissible. If omitted, the numerals under the bars are not printed.)
- 0: Non-print
 - 1: Print

qq: No. of zeros to be suppressed
(Omissible. If omitted, the zero suppression process is not performed.)
00 to 20

sss ----- sss: Data string to be printed (Omissible)
Max. 126 digits. However, it varies depending on the type of bar code.

tt₁, tt₂, tt₃, -----, tt₂₀: Link field No. (Omissible)
01 to 99 (1 to 99 can be also used.)
Up to 20 fields can be designated using commas.

* Omissible parameters (such as "Increment/decrement", "Selection of print or non-print of numerals under bars" and "No. of zeros to be suppressed") cannot be set when the postal code (Customer bar code, POSTNET, RM4SCC, KIX CODE) is selected.

⊙ In the case of MSI, Interleaved 2 of 5, CODE39, NW7, and Industrial 2 of 5

Format	<p>① [ESC] XBaa; bbbb, cccc, d, e, ff, gg, hh, ii, jj, k, llll (, mnnnnnnnnnn, p, qq) (, r) (=sss-----sss) [LF] [NUL]</p> <p>② [ESC] XBaa; bbbb, cccc, d, e, ff, gg, hh, ii, jj, k, llll (, mnnnnnnnnnn, p, qq) (, r) (; tt₁, tt₂, tt₃, -----, tt₂₀) [LF] [NUL]</p>
--------	---

Term	<p>aa: Bar code number 00 to 31</p> <p>bbbb: Print origin of X-coordinate of the bar code Fixed as 4 digits (in 0.1 mm units)</p> <p>cccc: Print origin of Y-coordinate of the bar code 4 or 5 digits (in 0.1 mm units)</p> <p>d: Type of bar code 1: MSI 2: Interleaved 2 of 5 (ITF) 3: CODE39 (standard) 4: NW7 B: CODE39 (full ASCII) O: Industrial 2 of 5</p> <p>e: Type of check digit 1: Without attaching check digit 2: Check digit check CODE39 Modulus 43 MSI IBM modulus 10 ITF Modulus 10 Industrial 2 of 5 Modulus check character 3: Check digit auto attachment (1) CODE39 Modulus 43 MSI IBM modulus 10 ITF Modulus 10 Industrial 2 of 5 Modulus check character 4: Check digit auto attachment (2) MSI IBM modulus 10 + IBM modulus 10 ITF DBP Modulus 10 5: Check digit auto attachment (3) MSI IBM modulus 11 + IBM modulus 10</p> <p>ff: Narrow bar width 01 to 99 (in dots)</p> <p>gg: Narrow space width 01 to 99 (in dots)</p> <p>* In the case of industrial 2 of 5, an element-to-element space is designated.</p> <p>hh: Wide bar width 01 to 99 (in dots)</p>
------	--

- ii: Wide space width
01 to 99 (in dots)
* In the case of industrial 2 of 5, the value is fixed to 00.
- jj: Character-to-character space width
01 to 99 (in dots)
* In the case of MSI and ITF, character-to-character space width is set to 00.
- k: Rotational angle of bar code
0: 0°
1: 90°
2: 180°
3: 270°
- lll: Height of the bar code
0000 to 1000 (in 0.1 mm units)
- mnnnnnnnnn: Increment/decrement
(Omissible. If omitted, incrementing/decrementing is not performed.)
m: Indicates whether to increment or decrement
+: Increment
-: Decrement
- nnnnnnnnnn: Skip value
0000000000 to 9999999999
- p: Selection of print or non-print of numerals under bars
(Omissible. If omitted, the numerals under the bars are not printed.)
0: Non-print
1: Print
- qq: No. of zeros to be suppressed
(Omissible. If omitted, the zero suppression process is not performed.)
00 to 20
- r: Designates the attachment of start/stop code
(Omissible. If omitted, the start/stop code is automatically attached.)
T: Attachment of start code only
P: Attachment of stop code only
N: Start/stop code unattached
- sss-----sss: Data string to be printed (Omissible)
Max. 126 digits. However, the number of digits varies depending on the type of bar code.
- tt₁, tt₂, tt₃, -----, tt₂₀: Link field No. (Omissible)
01 to 99 (1 to 99 can be also used.)
Up to 20 fields can be designated using commas.

⊙ In the case of Data Matrix (Two-dimensional code)

- | | |
|--------|---|
| Format | <p>① [ESC] XBaa; bbbb, cccc, d, ee, ff, gg, h (, Ciiijj) (, Jkklmmnnn) (= 000 -----000) [LF] [NUL]</p> <p>② [ESC] XBaa; bbbb, cccc, d, ee, ff, gg, h (, Ciiijj) (, Jkklmmnnn) (= pp₁, pp₂, pp₃, -----, pp₂₀) [LF] [NUL]</p> |
|--------|---|

- | | |
|------|---|
| Term | <p>aa: Bar code number
00 to 31</p> <p>bbbb: Print origin of X-coordinate of the bar code
Fixed as 4 digits (in 0.1 mm units)</p> <p>cccc: Print origin of Y-coordinate of the bar code
4 or 5 digits (in 0.1 mm units)</p> <p>d: Type of bar code
Q: Data Matrix (Two-dimensional code)</p> <p>ee: ECC type
00 to 14: If value "00" to "14" is designated, barcode command is ignored.
20: ECC200</p> <p>ff: 1-cell width
00 to 99 (in dots)</p> <p>gg: Format ID
No function (ignore)</p> <p>h: Rotational angle of bar code
0: 0°
1: 90°
2: 180°
3: 270°</p> <p>Ciiijj: No. of cells
(Omissible. If omitted, it is automatically set.)
iii: No. of cells in X direction 000 to 144
jjj: No. of cells in Y direction 000 to 144</p> |
|------|---|

* Cell setting varies according to the ECC type.

	ECC200
No. of cells to be designated	Even numbers only
Min./Max. No. of cells	10 × 10 to 144 × 144
Rectangular code	18 × 8
	32 × 8
	26 × 12
	36 × 12
	36 × 16
	48 × 16

- When this parameter is omitted, the number of cells is automatically set. Also, when any data other than the above values is designated for the number of cells in X and Y directions, the number of cells is automatically set.

Jkklmmnnn: Connection setting
(Omissible. No connection if this parameter is omitted.)

kk:	Code number	01 to 16
ll:	No. of divided codes	02 to 16
mmm:	ID number 1	001 to 254
nnn:	ID number 2	001 to 254

ooo ----- ooo: Data string to be printed (Omissible)
Max. 2048 digits.

pp1, pp2, pp3, -----, pp20: Link field No. (Omissible)
01 to 99 (1 to 99 can also be used.)
Up to 20 fields can be designated using commas.

⊙ In the case of PDF417 (Two-dimensional code)

Format	
	① [ESC] XBaa; bbbb, cccc, d, ee, ff, gg, h, iiiii (=jjj-----jjj) [LF] [NUL]
	② [ESC] XBaa; bbbb, cccc, d, ee, ff, gg, h, iiiii (; kk ₁ , kk ₂ , kk ₃ , -----, kk ₂₀) [LF] [NUL]
Term	
aa:	Bar code number 00 to 31
bbbb:	Print origin of X-coordinate of the bar code Fixed as 4 digits (in 0.1 mm units)
cccc:	Print origin of Y-coordinate of the bar code 4 or 5 digits (in 0.1 mm units)
d:	Type of bar code P: PDF417 (Two-dimensional code)
ee:	Security level 00: Level 0 01: Level 1 02: Level 2 03: Level 3 04: Level 4 05: Level 5 06: Level 6 07: Level 7 08: Level 8
ff:	1-module width 01 to 10 (in dots)
gg:	No. of columns (strings) 01 to 30
h:	Rotational angle of bar code 0: 0° 1: 90° 2: 180° 3: 270°
iiii:	Bar height 0000 to 0100 (in 0.1 mm units)
jjj-----jjj:	Data string to be printed (Omissible) Max. 2,048 digits
kk ₁ , kk ₂ , kk ₃ , -----, kk ₂₀ :	Link field No. (Omissible) 01 to 99 (1 to 99 can be also used.) Up to 20 fields can be designated using commas.

⊙ In the case of MicroPDF417 (Two-dimensional code)

Format	
	① [ESC] XBaa; bbbb, cccc, d, ee, ff, gg, h, iiiii (=jjj-----jjj) [LF] [NUL]
	② [ESC] XBaa; bbbb, cccc, d, ee, ff, gg, h, iiiii (; kk ₁ , kk ₂ , kk ₃ , -----, kk ₂₀) [LF] [NUL]
Term	<p>aa: Bar code number 00 to 31</p> <p>bbbb: Print origin of X-coordinate of the bar code Fixed as 4 digits (in 0.1 mm units)</p> <p>cccc: Print origin of Y-coordinate of the bar code 4 or 5 digits (in 0.1 mm units)</p> <p>d: Type of bar code X: MicroPDF417 (Two-dimensional code)</p> <p>ee: Security level 00: Fixed</p> <p>ff: 1-module width 01 to 10 (in dots)</p> <p>gg: No. of columns/rows 00 to 38</p> <p>h: Rotational angle of bar code 0: 0° 1: 90° 2: 180° 3: 270°</p> <p>iiii: Bar height 0000 to 0100 (in 0.1 mm units)</p> <p>jjj-----jjj: Data string to be printed (Omissible) Max. 366 digits</p> <p>kk₁, kk₂, kk₃, -----, kk₂₀: Link field No. (Omissible) 01 to 99 (1 to 99 can also be used.) Up to 20 fields can be designated using commas.</p>

The maximum number of columns and rows for the MicroPDF417

Parameter (gg)	No. of columns	No. of rows	Max. number of digits for binary mode	Max. number of digits for upper case letter/space mode	Max. number of digits for numeric mode
00	–	–	150	250	366
01	1	–	22	38	55
02	2	–	43	72	105
03	3	–	97	162	237
04	4	–	150	250	366
05	1	11	3	6	8
06		14	7	12	17
07		17	10	18	26
08		20	13	22	32
09		24	18	30	44
10		28	22	38	55
11	2	8	8	14	20
12		11	14	24	35
13		14	21	36	52
14		17	27	46	67
15		20	33	56	82
16		23	38	64	93
17		26	43	72	105
18	3	6	6	10	14
19		8	10	18	26
20		10	15	26	38
21		12	20	34	49
22		15	27	46	67
23		20	39	66	96
24		26	54	90	132
25		32	68	114	167
26		38	82	138	202
27		44	97	162	237
28	4	4	8	14	20
29		6	13	22	32
30		8	20	34	49
31		10	27	46	67
32		12	34	58	85
33		15	45	76	111
34		20	63	106	155
35		26	85	142	208
36		32	106	178	261
37		38	128	214	313
38		44	150	250	366

“–” for parameter 00 to 04 indicates that the numbers of columns/rows are automatically set by the printer. In this case, the pattern which has a smaller number of code words is automatically selected. When the numbers of code words is equal, the smaller number of columns is selected.

⊙ In the case of QR code (Two-dimensional code)

Format	<p>① [ESC] XBaa; bbbb, cccc, d, e, ff, g, h (, Mi) (, Kj) (, Jkklmm) (= nnn --- nnn) [LF] [NUL]</p> <p>② [ESC] XBaa; bbbb, cccc, d, e, ff, g, h (, Mi) (, Kj) (, Jkklmm) (= oo₁, oo₂, oo₃ ----- oo₂₀) [LF] [NUL]</p>
Term	<p>aa: Bar code number 00 to 31</p> <p>bbbb: Print origin of X-coordinate of the bar code Fixed as 4 digits (in 0.1 mm units)</p> <p>cccc: Print origin of Y-coordinate of the bar code 4 or 5 digits (in 0.1 mm units)</p> <p>d: Type of bar code T: QR code (Two-dimensional code)</p> <p>e: Designation of error correction level L: High density level M: Standard level Q: Reliability level H: High reliability level</p> <p>ff: 1-cell width 00 to 52 (in dots)</p> <p>g: Selection of mode M: Manual mode A: Automatic mode</p> <p>h: Rotational angle of the bar code 0: 0° 1: 90° 2: 180° 3: 270°</p> <p>Mi: Selection of model (Omissible. If omitted, Model 1 is automatically selected.) i = 1: Model 1 2: Model 2</p> <p>Kj: Mask number (Omissible. If omitted, the number is automatically set.) j = 0 to 7: Mask number 0 to 7 8: No mask</p> <p>Jkklmm: Connection setting (Omissible. No connection if this parameter is omitted.) kk = 01 to 16: Value indicating which divided code is connected. ll = 01 to 16: Number of divided codes mm = 00 to FF: A value for all data to be printed, to which XOR is applied in units of bytes (Not divided)</p> <p>nnn --- nnn: Data string to be printed (Omissible) Max. 2000 digits</p> <p>oo₁ --- oo₂₀: Link field No. (Omissible) 01 to 99 (1 to 99 can also be used.) Up to 20 digits can be designated using commas.</p>

⊙ In the case of MaxiCode (Two-dimensional code)

Format	① [ESC] XBaa; bbbb, cccc, d (, e) (, Jffgg) (, Zh) [LF] [NUL]
Term	<p>aa: Bar code number 00 to 31</p> <p>bbbb: Print origin of X-coordinate of the bar code Fixed as 4 digits (in 0.1 mm units)</p> <p>cccc: Print origin of Y-coordinate of the bar code 4 or 5 digits (in 0.1 mm units)</p> <p>d: Type of bar code Z: MaxiCode (Two-dimensional code)</p> <p>e: Mode selection (Omissible) Omitted: Mode 2 0: Mode 0 (Old specification) 1: Mode 1 (Old specification) 2: Mode 2 (New specification) 3: Mode 3 (New specification) 4: Mode 4 (New specification) 5: Mode 2 (New specification) 6: Mode 6 (New specification) 7: Mode 2 (New specification) 8: Mode 2 (New specification) 9: Mode 2 (New specification)</p> <p>Jffgg: Connection setting (Omissible. No connection if this parameter is omitted.) (If mode 0 or mode 1 is designated, it is ignored.) ff: Code number 01 to 08 gg: No. of divided codes 01 to 08</p> <p>Zh: Attachment of Zipper block and Contrast block (If mode 0 or mode 1 is designated, it is ignored.) (Omissible. If omitted, they are not attached.) h= 0: No attachment of Zipper block and Contrast block 1: Attachment of Zipper block and Contrast block 2: Attachment of Zipper block 3: Attachment of Contrast block</p>

Explanation

(1) Bar code number

When drawing by the Data Command ([ESC] RB), the format designated by the bar code is selected.

(2) Print origin of coordinates

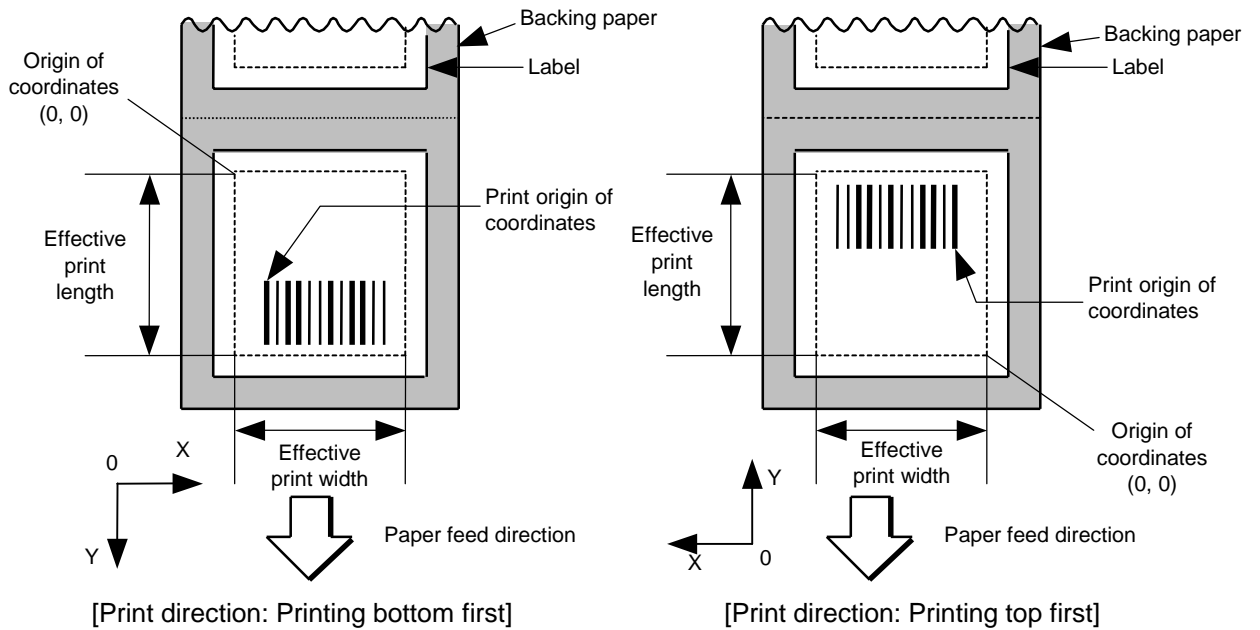

The print origin of coordinates must be set so that the result of bar code drawing will be within the effective print area set by the Label Size Set Command ([ESC] D).

[Effective print area]

[mm]

Model		B-SV4D			
Item	Method	Batch	Strip	Cutter	
Effective print width	Min.	13.0			
	Max.	108 ± 0.2			
Effective print length	Label	Min.	8.0	23.4	13.0
		Max.	607.6		
	Tag	Min.	8.0	-	13.0
		Max.	607.6	-	607.6

(3) Type of bar code

0: JAN8, EAN8



1: MSI



2: Interleaved 2 of 5



3: CODE39 (standard)



4: NW7



5: JAN13, EAN13



6: UPC-E



7: EAN13 + 2 digits



8: EAN13 +5 digits



9: A: CODE128



B: CODE39 (Full ASCII)



C: CODE93



G: UPC-E + 2 digits



H: UPC-E + 5 digits



I: EAN8 + 2 digits



J: EAN8 + 5 digits



K: UPC-A



L: UPC-A + 2 digits



M: UPC-A + 5 digits



N: UCC/EAN128



O: Industrial 2 of 5



P: PDF417



Q: Data Matrix



R: Customer bar code



S: Highest priority customer bar code



T: QR code



U: POSTNET



V: RM4SCC



W: KIX code



X: MicroPDF417



Z: MaxiCode

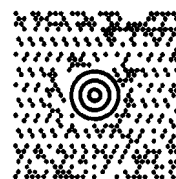

(4) Type of check digit

- ① Where no check digit is attached, the bar code of the data row will be drawn.
- ② In the case of the check digit check, if each check digit checked according to the type of bar code is normal, the bar code will be drawn. If the check digit not meeting the requirement is designated, the bar code will not be drawn.
- ③ In the case of the check digit auto attachment, each check digit is attached according to the type of bar code and the bar code is drawn.
- ④ If the type of bar code is CODE93, CODE128 (with auto code selection), or UCC/EAN128, the check digit will always be attached regardless of the designation of the type of check digit.
- ⑤ If the type of bar code is JAN, EAN, or UPC, the designation of no check digit attachment automatically assume the check digit check.
- ⑥ DBP Modulus 10 is Modulus 10 for Deutsche Bundespost Postdienst only.

(5) Bar width, space width, and character-to-character space

Designate the bar, space, and character-to-character space widths according to the type of bar code. Note that the designated proper value differs according to the rotational angle of bar code, type, number of digits, print speed, paper used, etc. Examples of such designations are listed below. (1 dot = 1/12 mm)

In the case of JAN, EAN, UPC, CODE93, CODE128, UCC/EAN128, PDF417, or MicroPDF417, a 2 to 6-module width is calculated automatically when a 1-module width is designated.

Type of bar code	1 module		2 modules		3 modules		4 modules		5 modules		6 modules	
	Bar	Space	Bar	Space	Bar	Space	Bar	Space	Bar	Space	Bar	Space
JAN, EAN, UPC	4		8		12		16		-		-	
CODE93	3		6		9		12		-		-	
CODE128, EAN128	3		6		9		12		-		-	
PDF417	3		6		9		12		15		18	
MicroPDF417	2		4		6		8		10		12	

Type of bar code	Narrow		Wide		Character-to-character space
	Bar	Space	Bar	Space	
MSI	3	3	8	8	0
ITF	3	3	8	8	0
CODE39	3	3	8	8	3
NW7	3	3	8	8	3
Industrial 2 of 5	3	3	8	0	3

When NW7 is used, transmission of the space character assumes the space of (narrow space x12) dots. In this case, the space is max. 255 dots.

In the case of Data Matrix

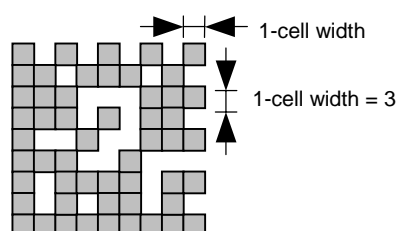

When 1-cell width is 00 for the Data Matrix, a two-dimensional code is not drawn. However, the two-dimensional code printed on the previous label is cleared.

In the case of QR code

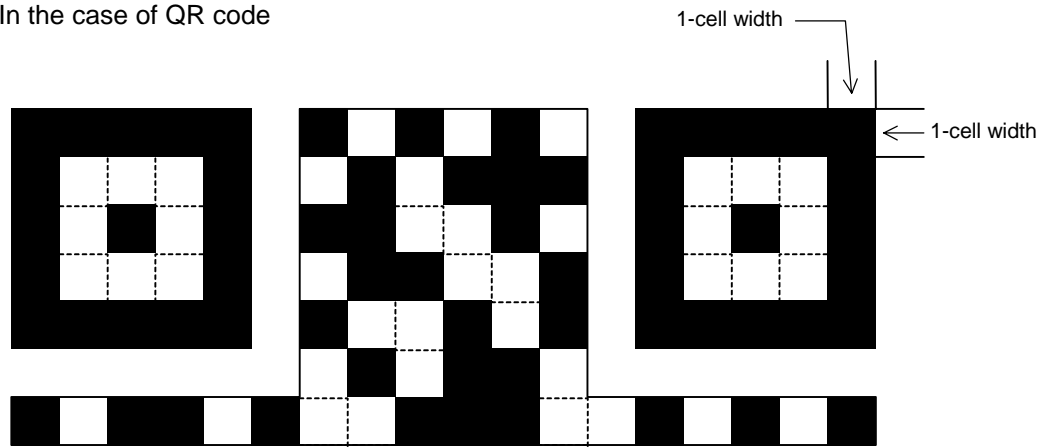

When the 1-cell width is 0, a two-dimensional code is not drawn. However, the bar code printed on the previous label is cleared.

In the case of a postal code

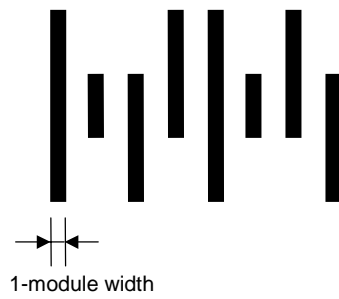

(6) Rotational angle of bar code

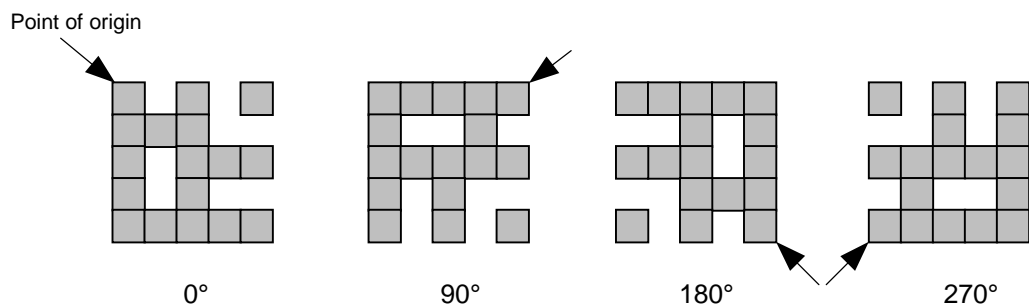
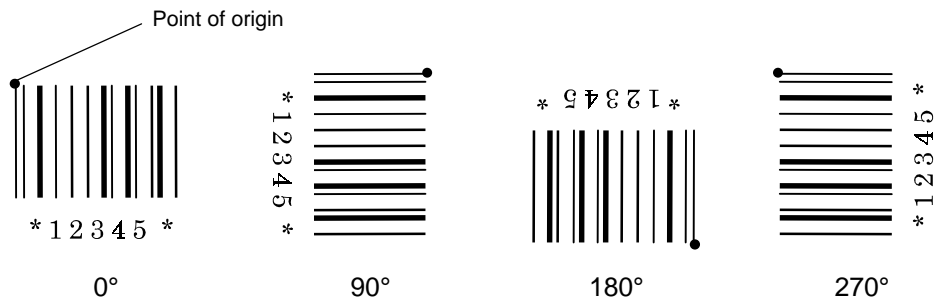

(7) Bar code height

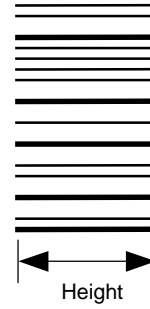

[PDF417, MicroPDF417]



[Postal code]

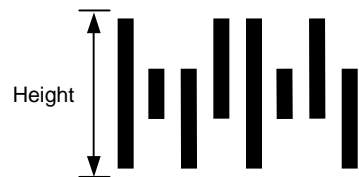

When the bar code height is 0000, bar code (including guard bars) and numerals under bars are not drawn. However, the bar code printed on the previous label is cleared.

(8) Length of guard bar

The length of guard bar is valid only when the type of bar code is WPC. It is ignored in any other cases.

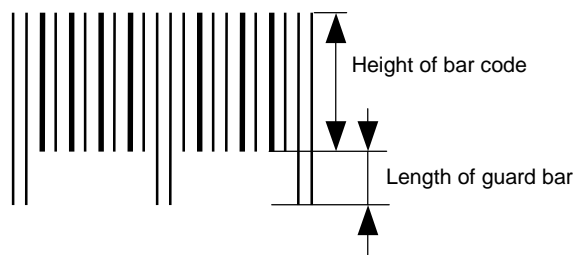

(9) Numerals under bars

Numerals are not or provided under bars according the parameter for the presence or absence of numerals under bars. The contents of numerals under bars to be printed vary according to the type of bar code. The character set of numerals under bars is OCR-B. Such numerals are enlarged or reduced only horizontally according to the width of the bar code. They are drawn vertically in the fixed one magnification.

[Drawing positions of numerals under bars]

- ① In the case of JAN and EAN
(Example) EAN13 + 2 digits

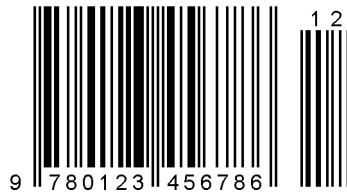

(Example) EAN8



- ② In the case of UPC
(Example) UPC-A + 2 digits



(Example) UPC-E



- ③ In the case of bar codes other than JAN, EAN, and UPC
(Example) CODE39



(Example) UCC/EAN128

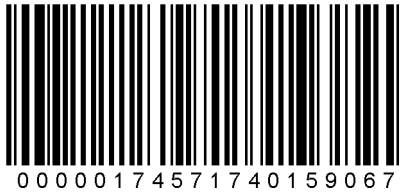

(10) Start/Stop Code

- This parameter is valid only when the type of bar code is CODE39 and NW7.
- Where the parameter is designated, the program will not check if the transmit print data is with a start code and stop code.
- When the parameter is omitted in the case of CODE39 and NW7, a start/stop code will be attached. The code to be added is “*” in the case of CODE39, and “a” in the case of NW7.
- For details, refer to “Auto Attachment of Start/Stop Code” to be discussed later in this specification.

(11) Increment/decrement

Printing is performed while the data is incremented or decremented every time a label is issued. Where the data row exceeds the maximum number of digits (40), the data row will not be drawn.

When CODE128 (without auto code selection) is used, the number of the start code (code A, code B, and code C) digits is regarded as 2.

Initial value	0000	0000	0000	0000	999999
INC/DEC	+10	+10	+10	+10	+1
Zero suppression	Not designated	5	3	0	3
1st label	0000	0000	└000	0000	999999
2nd label	0010	0010	└010	0010	└└└000
3rd label	0020	0020	└020	0020	└└└001
4th label	0030	0030	└030	0030	└└└002
5th label	0040	0040	└040	0040	└└└003

Letters and numerals for increment/decrement

For CODE39 (standard), CODE39 (full ASCII), NW-7, CODE93, CODE128, if a data string other than numerals is included in the data, increment/decrement designation is performed. If any code which does not exist in each bar code table is contained in the data, increment/decrement designation is not performed.

Up to 40 digits (including letters, numerals and symbols) are possible. Only the numerals are picked up and calculated for incrementing/decrementing, and then are returned to the previous position to draw the data.

Example of increment/decrement calculation

Initial value	00000	A0A0A	7A8/9	A2A0A
INC/DEC	+1	+1	+3	-3
1st label	00000	A0A0A	7A8/9	A2A0A
2nd label	00001	A0A1A	7A9/2	A1A7A
3rd label	00002	A0A2A	7A9/5	A1A4A
4th label	00003	A0A3A	7A9/8	A1A1A
5th label	00004	A0A4A	8A0/1	A0A8A

Example of increment/decrement of data including the special codes of CODE128

Increment/decrement calculation starts from the last digit in the data strings. When the data string to be calculated is numeric, and the next (upper) digit is ">", that is a special code (shown with underline below). The next digit is calculated without incrementing/decrementing these two digits.

Example of increment/decrement calculation of CODE128

Initial value	00000	00> <u>08</u>	0A> <u>08</u>	0A9> <u>08</u>
INC/DEC	+1	+1	+1	+1
1st label	00000	00> <u>08</u>	0A> <u>08</u>	0A9> <u>08</u>
2nd label	00001	00> <u>09</u>	0A> <u>09</u>	0A9> <u>09</u>
3rd label	00002	01> <u>00</u>	1A> <u>00</u>	1A0> <u>00</u>
4th label	00003	01> <u>01</u>	1A> <u>01</u>	1A0> <u>01</u>
5th label	00004	01> <u>02</u>	1A> <u>02</u>	1A0> <u>02</u>

(12) Zero suppression

No. of zeros to be suppressed	0	1	2	2	3	4	5
Data	0000	0000	0000	0A12	0123	0123	0123
Print	0000	┐┐┐0	┐┐00	┐A12	┐123	0123	0123

The leading zero(s) in a data row is replaced by a space(s) according to the designated number of digits. However, if the number of digits to be suppressed is greater than the data row, the data row will be drawn without zero suppression. Where the data row exceeds the maximum number of digits (40), the data row will not be drawn.

When the print data including start/stop code is sent to sending print data, the start/stop code is also counted as a digit. When the bar code type is JAN, EAN, UPC, or UCC/EAN 128, the data will be drawn without zero suppression.

(13) Data string to be printed

Drawing data can be programmed by designating the number of digits after the symbol “=”.” The maximum number of digits to be printed varies according to the types of bar codes. For codes, refer to the bar code table mentioned later.

(14) Link field No.

The link field No. can be programmed by designating it after the symbol “;.” After the link field No. is designated using the Format Command, the data string are linked by the Link Field Data Command to draw an image.

Up to 20 fields can be linked.

The following shows an example of linked fields on the two continuous labels.

[Format Command]

[ESC] PC01;..... ; 01 [LF] [NUL] : Link field No. 1 is designated.
[ESC] PC02;..... ; 03 [LF] [NUL] : Link field No. 3 is designated.
[ESC] PC03;..... ; 04 [LF] [NUL] : Link field No. 4 is designated.
[ESC] XB01; ; 03, 04 [LF] [NUL] : Link fields No. 3 and No. 4 are designated.

[ESC] PC04;..... ; 02 [LF] [NUL] : Link field No. 2 is designated.
[ESC] PC05;..... ; 03 [LF] [NUL] : Link field No. 3 is designated.
[ESC] PC06;..... ; 04 [LF] [NUL] : Link field No. 4 is designated.
[ESC] XB02; ; 03, 04 [LF] [NUL] : Link fields No. 3 and No. 4 are designated.

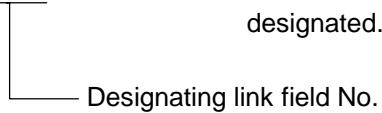

[Data Command]

[ESC] RB; A [LF] B [LF] ABCD [LF] 001 [LF] [NUL]

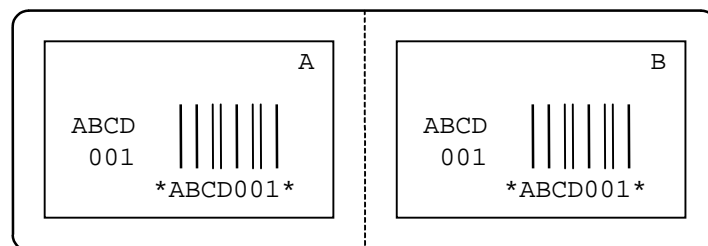
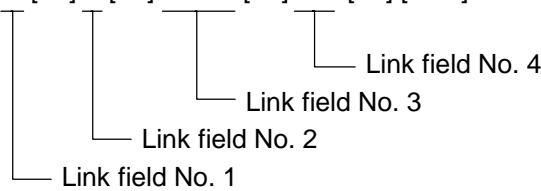

(15) Explanation for Data Matrix

① ECC type

Data Matrix contains a function to correct a code reading error using an error correction code (ECC) and restore normal data. Since there are several ECCs, ECC should be designated according to usage. The general correction ability is as follows. However, it may vary according to the error conditions.

ECC type	Overhead by ECC
ECC200	Approx. 30%

② Format ID No function (Ignore)

③ Maximum number of digits

The maximum number of digits varies according to the ECC type. Since each Kanji character uses 2 bytes, the maximum number of digits for it becomes half of the following values.

	Numeric	Alphanumeric	8 bit
ECC200	2000	2000	1556

For the maximum number of digits in cell units, see the next page.

④ Connection setting

The connection setting is used to comprise data with a set of two-dimensional codes when the data cannot be expressed with a two-dimensional code. When three two-dimensional codes are used to comprise data, identification information of 1/3, 2/3, and 3/3 is inserted into each two-dimensional code. The ID number is programmed to include a proper combination of two-dimensional codes when one label contains plural connecting symbols. For example, when there are two kinds of data containing identification information for 1/2 and 2/2 in the same label, combination of two-dimensional codes is unclear. By adding the ID number, the combination is made clear.

Cell size and the effective data capacity

Symbol size		ECC200		
		Numeric capacity	Alphanum capacity	8-bit byte Capacity
Row	Col			
10	10	6	3	1
12	12	10	6	3
14	14	16	10	6
16	16	24	16	10
18	18	36	25	16
20	20	44	31	20
22	22	60	43	28
24	24	72	52	34
26	26	88	64	42
32	32	124	91	60
36	36	172	127	84
40	40	228	169	112
44	44	288	214	142
48	48	348	259	172
52	52	408	304	202
64	64	560	418	278
72	72	736	550	366
80	80	912	682	454
88	88	1152	862	574
96	96	1392	1042	694
104	104	1632	1222	814
120	120	2000	1573	1048
132	132	2000	1954	1302
144	144	2000	2000	1556

Rectangular code

Symbol size		ECC200		
		Numeric capacity	Alphanum capacity	8-bit byte capacity
Row	Col			
8	18	10	6	3
8	32	20	13	8
12	26	32	22	14
12	36	44	31	20
16	36	64	46	30
16	48	98	72	47

(16) Explanation for the PDF417 and MicroPDF417

① Security level

The PDF417 contains a function to correct a code reading error using an error correcting code word and restore normal data. The security level should be designated according to usage to perform the error correction function.

For the MicroPDF417, the printer sets the security level automatically.

Security level	Error Correction Ability	No. of error correction code words
Level 0	<div style="display: flex; flex-direction: column; align-items: center;"> <div style="border: 1px solid black; padding: 2px 10px;">Low</div> <div style="margin: 5px 0;">↑</div> <div style="margin: 5px 0;">↓</div> <div style="border: 1px solid black; padding: 2px 10px;">High</div> </div>	0
Level 1		2
Level 2		6
Level 3		14
Level 4		30
Level 5		62
Level 6		126
Level 7		254
Level 8		510

② No. of columns (strings)

The number of rows is variable in the PDF417. The row length (No. of data strings) is also variable. Therefore, a symbol can be created in a form that can be easily printed, by changing the proportion of the height and width.

The number of columns (data strings) is variable between 1 and 30.

If the number of columns is small when data amount is large and security level is high, drawing may not be performed. This is because the number of rows exceeds 90 when the number of columns becomes small. (When the PDF417 is used, the number of rows of symbols is limited from 3 to 90.)

For the MicroPDF417, not only the number of columns (data strings) but also the number of rows (data lines) can be designated. When these are to be designated, see the table on page 72. Note that the max. number of digits for the set parameter (gg) varies according to the character type. If data over the max. number of digits for the set parameter (gg) is set, the bar code is not printed. The number of columns (data strings) is variable from 1 to 4.

However, the max. number of lines, which is 44, depends on the number of columns.

(17) Explanation for QR code

① Error correction level

The QR code contains functions to detect and correct an error. If one of the data characters is damaged, the information can be restored when this code is read.

There are 4 levels that can be designated. The level should be specified according to usage. The general correction ability is as follows.

Level	Error correction ability	Overhead by correcting an error
High density level	<div style="display: flex; flex-direction: column; align-items: center;"> <div style="margin-bottom: 5px;">Low</div> <div style="margin: 5px 0;">↑</div> <div style="margin: 5px 0;">↓</div> <div style="margin-top: 5px;">High</div> </div>	7%
Standard level		15%
Reliability level		25%
High reliability level		30%

② 1-cell width

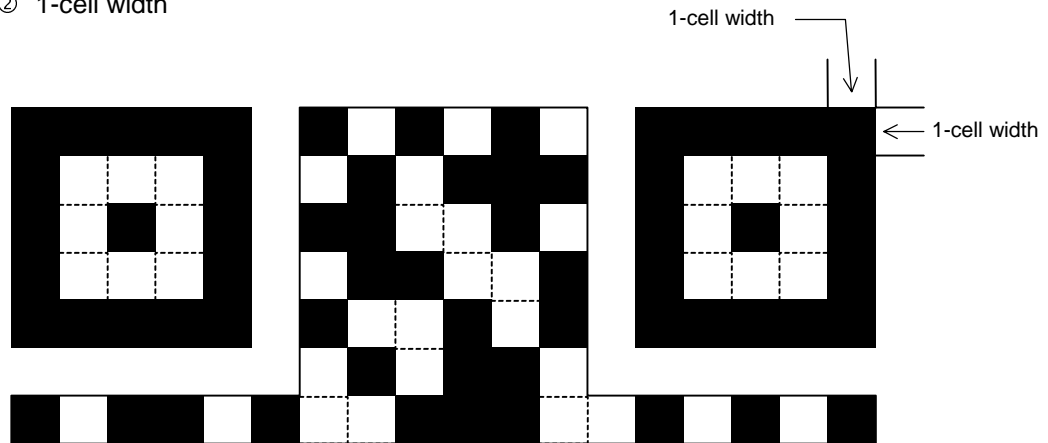

When the 1-cell width is 0, a two-dimensional code is not drawn. However, the two-dimensional code printed on the previous label is cleared.

③ Selection of mode

All codes including alphanumerics, symbols, and Kanji can be used in one QR code. Manual mode or automatic mode can be selected to perform the operation.

④ Selection of model

Model 1: Original specification

Model 2: Extended specification which enhances the function of position correction and can contain a large amount of data.

⑤ Mask number

To be sure to read the QR code, it is preferable that white and black modules are arranged in this symbol in a balanced manner. This prevents the bit pattern "1011101", which is characteristically seen in the position detecting pattern, from appearing in the symbol as much as possible.

The mask number is 0 to 7. The pattern is determined by placing each masking pattern for the mask number upon the module pattern. When the mask number is set to 8, masking is not performed. When the parameter is omitted, the most appropriate mask number is automatically selected to perform masking.

⑥ Connection setting

For QR code, data can be divided into several codes. Even though there is only a narrow print space, the code can be entered in the space by dividing the code. The data can be divided into a max. of 16 codes. Parity data is obtained by XORing all input data in units of bytes before dividing. The input data is calculated based on shift JIS for Kanji, or on JIS 8 for others. Examples are shown below:

"0123456789日本" is divided into "0123", "4567", and "89日本".

Code No. 1	No. of divided codes: 3	Parity data: 84	Data "0123"
Code No. 2	No. of divided codes: 3	Parity data: 84	Data "4567"
Code No. 3	No. of divided codes: 3	Parity data: 84	Data "89日本"

* The parity data is the XORed value for "0123456789日本".

$$30\ 31\ 32\ 33\ 34\ 35\ 36\ 37\ 38\ 39\ 93\ FA\ 96\ 7B = 84$$

(18) Explanation for MaxiCode

① Connection setting

For MaxiCode, data can be divided into a max. of 8 codes.

Notes

(1) The check digit attach and increment/decrement, and zero suppress processes are performed according to the following priority. If any of the conditions is improper, no drawing will take place.

[For example, the zero(s) is replaced by a space(s) as a result of zero suppression but the modulus 10 designated to be attached cannot be calculated.]

Increment/decrement > zero suppression > attachment of check digit

(2) Up to 32 fields for which incrementing/decrementing has been designated can be drawn. If the total of bit map font, outline font or bar code increment/decrement fields exceeds 32, drawing will take place without incrementing/decrementing any excessive field. The field to be incremented or decremented is incremented or decremented until the Image Buffer Clear Command ([ESC] C) is transmitted.

[Example]

- ① Format Command (Increment bar code No. 01 (+1))
- ② Format Command (Increment bar code No. 02 (+2))
- ③ Image Buffer Clear Command
- ④ Data Command (Bar code No. 01 "0001")
- ⑤ Data Command (Bar code No. 02 "0100")
- ⑥ Issue Command (2 labels)



- ⑦ Issue Command (1 label)



- ⑧ Image Buffer Clear Command
- ⑨ Data Command (Bar code No. 02 "3000")
- ⑩ Issue Command (1 label)



- (3) More than one Bar Code Format Command can be connected when transmitted.

[ESC] XB01; 0100, 0150, 3, 1, 02, 02, 06, 06, 02, 0, 0150 [LF]

B02; 0350, 0150, 3, 1, 02, 02, 06, 06, 02, 0, 0150 [LF] [NUL]

- (4) When the drawing data is changed per label issue during printing, the field of the drawing data for the previous label is automatically cleared using the bar code number, then the next drawing data is printed. Therefore, the bar code number which differs according to the drawing fields should be designated. Since the automatic field clear is not performed between the Clear Command ([ESC] C) and issue Command ([ESC] XS), the fixed data may be drawn using the same bar code number. In this case, the Format Command and Data Command should be sent alternately. (After the Issue Command is sent, the fields with the same bar code number are automatically cleared until the Clear Command is sent.)
- (5) The link field designation is cleared by omitting the link field designation using the same bar code No. and reformatting data.
The link field designation can be also cleared by the Image Buffer Clear Command.
- (6) A print data string and link field No. cannot be programmed at the same time.
- (7) The same barcode number cannot be programmed more than once in one format (one page).

Refer to

Bit Map Font Format Command ([ESC] PC)

Outline Font Format Command ([ESC] PV)

Bar Code Data Command ([ESC] RB)

Examples

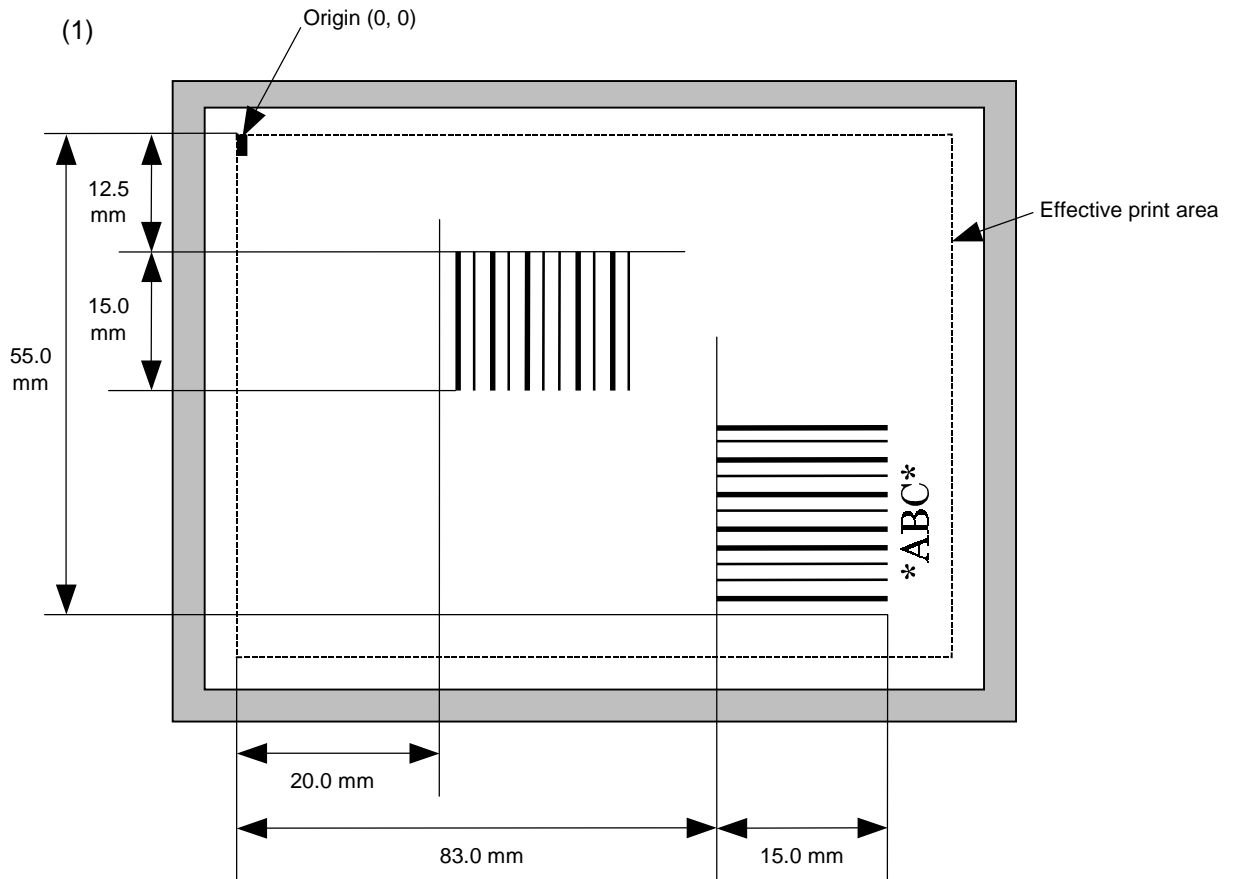

[ESC] C [LF] [NUL]

[ESC] XB01; 0200, 0125, 3, 1, 03, 03, 08, 08, 03, 0, 0150=12345 [LF] [NUL]

[ESC] XB02; 0830, 0550, 3, 1, 02, 04, 07, 08, 04, 3, 0150, +0000000000, 1, 00, N [LF] [NUL]

[ESC] RB02; *ABC* [LF] [NUL]

[ESC] XS; I, 0002, 0002C3000 [LF] [NUL]

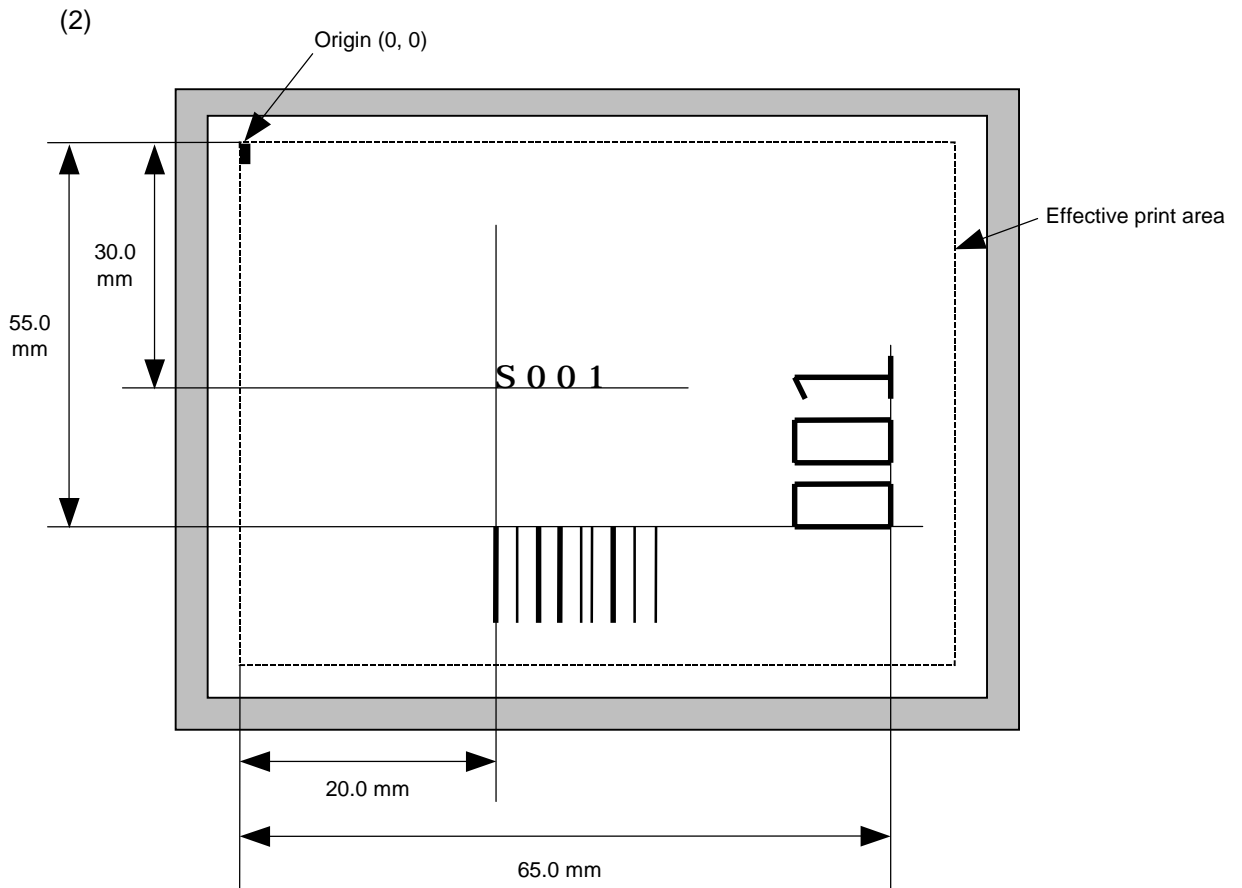

```
[ESC] C [LF] [NUL]
[ESC] PC001; 0200, 0300, 1, 1, C, 00, B; 01, 02 [LF] [NUL]
[ESC] PV01; 0650, 0550, 0200, 0150, B, 33, B; 02 [LF] [NUL]
[ESC] XB01; 0200, 0550, 3, 1, 03, 03, 08, 08, 03, 0, 0150; 01, 02 [LF] [NUL]
[ESC] RB; S [LF] 001 [LF] [NUL]
[ESC] XS; I, 0002, 0002C3000 [LF] [NUL]
```

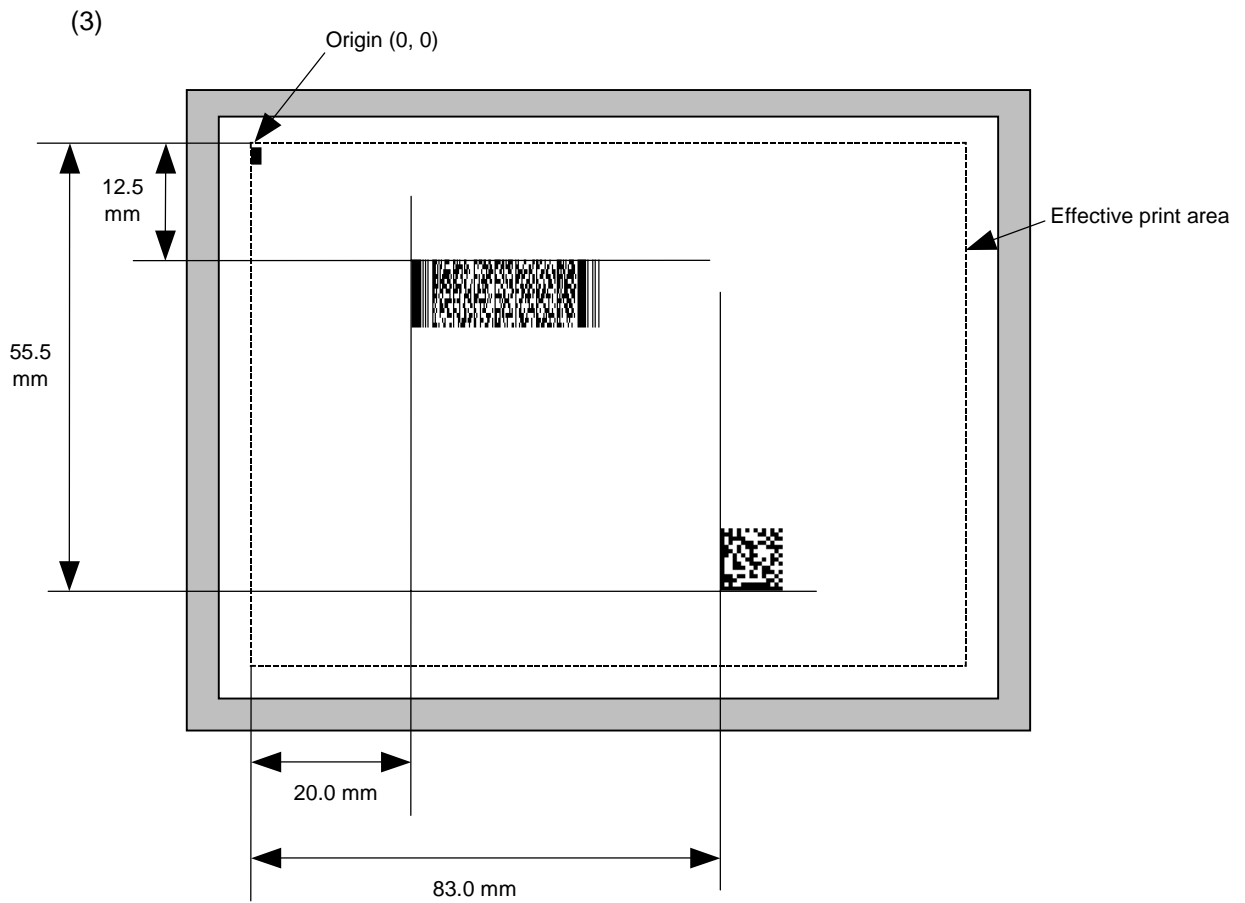
```
[ESC] C [LF] [NUL]
[ESC] XB01; 0200, 0125, P, 04, 02, 03, 0, 0010 [LF] [NUL]
[ESC] XB02; 0830, 0550, Q, 08, 03, 05, 3 [LF] [NUL]
[ESC] RB01; PDF417 [LF] [NUL]
[ESC] RB02; Data Matrix [LF] [NUL]
[ESC] XS; I, 0002, 0002C3000 [LF] [NUL]
```

6.3.10 BIT MAP FONT DATA COMMAND

[ESC] RC

Function	Provides data for the bit map font row.
Format	<p>① [ESC] RCaaa; bbb ----- bbb [LF] [NUL]</p> <p>② Link Field Data Command [ESC] RC; ccc ----- ccc [LF] ddd ----- ddd [LF] ----- [LF] xxx ----- xxx [LF] [NUL]</p>
Term	<p>aaa: Character string number 000 to 199 (Two digits, 00 to 99, also acceptable.)</p> <p>bbb ----- bbb: Data string to be printed Max. 255 digits (Max. 127 digits when the font type is 51, 52, 53, 54, or 55.) Any excess data will be discarded. For the character codes, refer to the character code table to be given later in this specification.</p> <p>ccc ----- ccc: Data string of link field No. 1</p> <p>ddd ----- ddd: Data string of link field No. 2 to</p> <p>xxx ----- xxx: Data string of link field No. 99</p>
Explanation	<p>(1) Link field data string</p> <ul style="list-style-type: none"> • After the link field No. is designated in the Format Command, data strings are linked using the Link Field Data Command to draw an image. • Up to 255 digits of data strings can be linked. However, when the font type is 51, 52, 53, 54, or 55, only up to 127 digits can be linked. When the number of digits exceeds the maximum value, excess data will be discarded. • Up to 99 data strings can be linked. • Up to 2048 bytes can be used as the command length ([ESC] to [NUL]) of the Link Field Data Command. • When the data string is omitted in the Link Field Data Command, the following process is performed: <ul style="list-style-type: none"> ① No process will be performed for the field which contains no print data due to the omission. ② When the field partially loses print data due to the omission, the only remaining data will be processed as print data. • The Link Field Data Command can be used for the bit map font fields, outline font fields, and bar code fields. (The same result is obtained when any of the "RC," "RV" or "RB" command code is designated.)
Refer to	Bit Map Font Format Command ([ESC] PC)

Examples

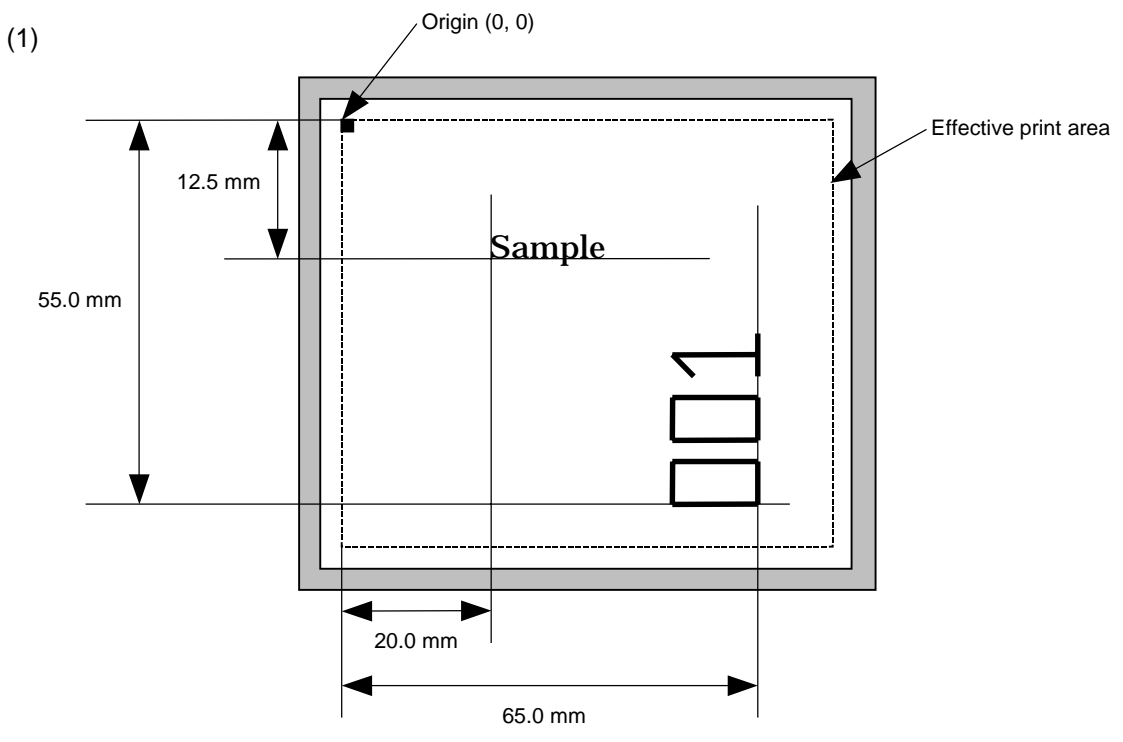

```
[ESC] C [LF] [NUL]  
[ESC] PC001; 0200, 0125, 1, 1, C, 00, B [LF] [NUL]  
[ESC] PC002; 0650, 0550, 2, 2, G, 33, B, +0000000001 [LF] [NUL]  
[ESC] RC001; Sample [LF] [NUL]  
[ESC] RC002; 001 [LF] [NUL]  
[ESC] XS; I, 0002, 0002C3000 [LF] [NUL]
```

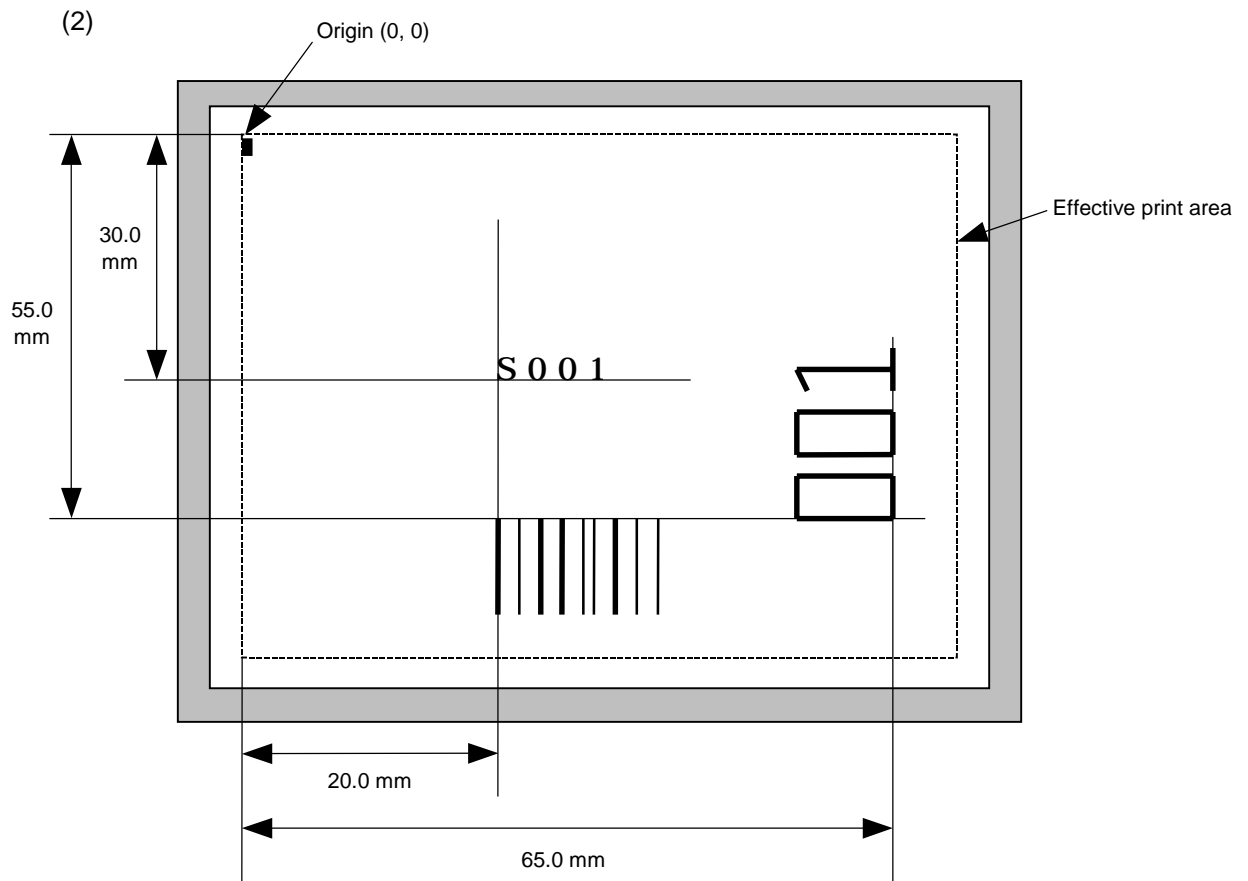

```
[ESC] C [LF] [NUL]
[ESC] PC001; 0200, 0300, 1, 1, C, 00, B; 01, 02 [LF] [NUL]
[ESC] PV01; 0650, 0550, 0200, 0150, B, 33, B; 02 [LF] [NUL]
[ESC] XB01; 0200, 0550, 3, 1, 03, 03, 08, 08, 03, 0, 0150; 01, 02 [LF] [NUL]
[ESC] RC; S [LF] 001 [LF] [NUL]
[ESC] XS; I, 0002, 0002C3000 [LF] [NUL]
```

6.3.11 OUTLINE FONT DATA COMMAND

[ESC] RV

Function	Provides data for the outline font row.
Format	<p>① [ESC] RVaa; bbb ----- bbb [LF] [NUL]</p> <p>② Link Field Data Command [ESC] RV; ccc ----- ccc [LF] ddd ----- ddd [LF] ----- [LF] xxx ----- xxx [LF] [NUL]</p>
Term	<p>aa: Character string number 00 to 99</p> <p>bbb ----- bbb: Data string to be printed Max. 255 digits Any excess data will be discarded. For the character codes, refer to the character code table to be given later in this specification.</p> <p>ccc ----- ccc: Data string of link field No. 1</p> <p>ddd ----- ddd: Data string of link field No. 2 to</p> <p>xxx ----- xxx: Data string of link field No. 99</p>
Explanation	<p>(1) Link field data string</p> <ul style="list-style-type: none"> • After the link field No. is designated in the Format Command, data strings are linked using the Link Field Data Command to draw an image. • Up to 255 digits of data strings can be linked. Data exceeding the max. number of digits will be discarded. • Up to 99 data strings can be linked. • Up to 2048 bytes can be used as the command length ([ESC] to [NUL]) of the Link Field Data Command. • When the data string is omitted in the Link Field Data Command, the following process is performed: <ul style="list-style-type: none"> ① No process will be performed for the field which contains no print data due to the omission. ② When the field partially loses print data due to the omission, the only remaining data will be processed as print data. • The Link Field Data Command can be used for the bit map font fields, outline font fields, and bar code fields. (The same result is obtained when any of the "RC," "RV" or "RB" command code is designated.)
Refer to	Outline Font Format Command ([ESC] PV)

Examples

(1)

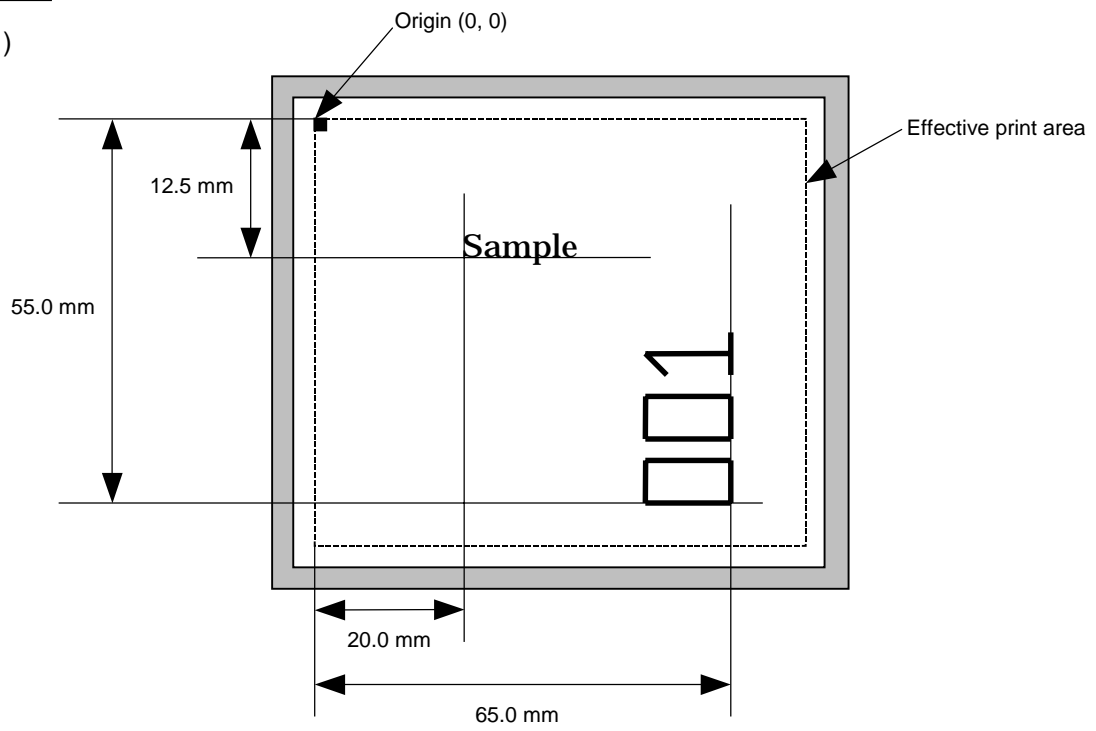

```
[ESC] C [LF] [NUL]  
[ESC] PV01; 0200, 0125, 0100, 0100, B, 00, B [LF] [NUL]  
[ESC] PV02; 0650, 0550, 0200, 0150, B, 33, B, +0000000001 [LF] [NUL]  
[ESC] RV01; Sample [LF] [NUL]  
[ESC] RV02; 001 [LF] [NUL]  
[ESC] XS; I, 0002, 0002C3000 [LF] [NUL]
```

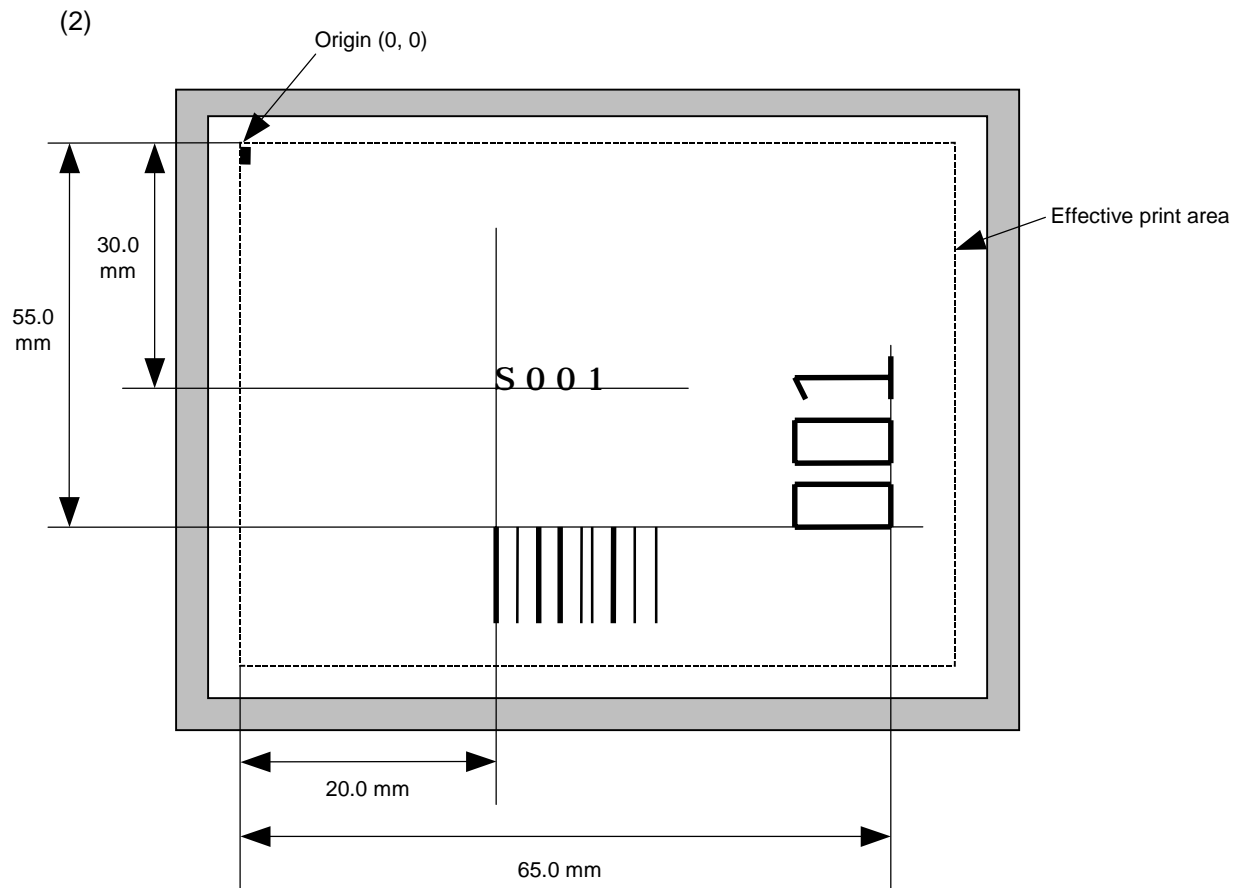

```
[ESC] C [LF] [NUL]
[ESC] PC001; 0200, 0300, 1, 1, C, 00, B; 01, 02 [LF] [NUL]
[ESC] PV01; 0650, 0550, 0200, 0150, B, 33, B; 02 [LF] [NUL]
[ESC] XB01; 0200, 0550, 3, 1, 02, 02, 06, 06, 02, 0, 0150; 01, 02 [LF] [NUL]
[ESC] RC; S [LF] 001 [LF] [NUL]
[ESC] XS; I, 0002, 0002C3000 [LF] [NUL]
```

6.3.12 BAR CODE DATA COMMAND

[ESC] RB

Function	Provides data for the bar code.
Format	① [ESC] RBaa; bbb ----- bbb [LF] [NUL] ② Link Field Data Command [ESC] RB; ccc ----- ccc [LF] ddd ----- ddd [LF] ----- [LF] xxx ----- xxx [LF] [NUL]
Term	aa: Bar code number 00 to 31 bbb ----- bbb: Data string to be printed The maximum number of digits varies according to the type of bar code. ccc ----- ccc: Data string of link field No. 1 ddd ----- ddd: Data string of link field No. 2 to xxx ----- xxx: Data string of link field No. 99 The Data Command for the MaxiCode is described later.

Explanation	<p>(1) Data check</p> <p>If there is data in the data row, which does not meet the type of bar code, the bar code will not be drawn. If wrong code selection takes place in the data row of CODE128 (without auto code selection), the bar code will not be drawn.</p> <p>If there is data different from the one designated using the format ID when Data Matrix is used, the symbol is not drawn.</p> <p>(2) No. of digits of data</p> <p>When data exceeding the maximum number of digits is sent, the excess data will be discarded. For the maximum number of digits for each bar code, see below.</p> <table style="margin-left: 40px;"> <tr> <td>Data Matrix, PDF417, QR code:</td> <td style="text-align: right;">2000 digits</td> </tr> <tr> <td>MicroPDF417:</td> <td style="text-align: right;">366 digits</td> </tr> <tr> <td>MaxiCode:</td> <td style="text-align: right;">93 digits</td> </tr> <tr> <td>Customer bar code:</td> <td style="text-align: right;">20 digits</td> </tr> <tr> <td>Highest priority customer bar code:</td> <td style="text-align: right;">19 digits</td> </tr> <tr> <td>POSTNET:</td> <td style="text-align: right;">5, 9, 11 digits</td> </tr> <tr> <td>ROYAL MAIL 4 STATE CUSTOMER CODE:</td> <td style="text-align: right;">12 digits</td> </tr> <tr> <td>KIX CODE:</td> <td style="text-align: right;">18 digits</td> </tr> <tr> <td>Bar codes other than the above</td> <td style="text-align: right;">126 digits</td> </tr> </table> <p>When the number of digits does not correspond to the bar code type, the bar code is not drawn.</p> <p>For the MaxiCode, the maximum number of digits varies according to the mode. In mode 2 or 3 and mode 4 or 6, the maximum number of digits is 84 and 93, respectively.</p>	Data Matrix, PDF417, QR code:	2000 digits	MicroPDF417:	366 digits	MaxiCode:	93 digits	Customer bar code:	20 digits	Highest priority customer bar code:	19 digits	POSTNET:	5, 9, 11 digits	ROYAL MAIL 4 STATE CUSTOMER CODE:	12 digits	KIX CODE:	18 digits	Bar codes other than the above	126 digits
Data Matrix, PDF417, QR code:	2000 digits																		
MicroPDF417:	366 digits																		
MaxiCode:	93 digits																		
Customer bar code:	20 digits																		
Highest priority customer bar code:	19 digits																		
POSTNET:	5, 9, 11 digits																		
ROYAL MAIL 4 STATE CUSTOMER CODE:	12 digits																		
KIX CODE:	18 digits																		
Bar codes other than the above	126 digits																		

The maximum number of digits for Data Matrix varies according to the settings for ECC type, format ID, and the cell size. In the case of Kanji, the maximum number of digits is half those of the values described below since a Kanji character occupies 2 bytes.

Max number of digits for Data Matrix

	Numeric	Alphanumeric	8 bit
ECC200	2000	2000	1556

Cell Size and Effective Data Capacity

Symbol size		ECC200		
		Numeric capacity	Alphanum capacity	8-bit byte capacity
Row	Col			
10	10	6	3	1
12	12	10	6	3
14	14	16	10	6
16	16	24	16	10
18	18	36	25	16
20	20	44	31	20
22	22	60	43	28
24	24	72	52	34
26	26	88	64	42
32	32	124	91	60
36	36	172	127	84
40	40	228	169	112
44	44	288	214	142
48	48	348	259	172
52	52	408	304	202
64	64	560	418	278
72	72	736	550	366
80	80	912	682	454
88	88	1152	862	574
96	96	1392	1042	694
104	104	1632	1222	814
120	120	2000	1573	1048
132	132	2000	1954	1302
144	144	2000	2000	1556

Rectangular code

Symbol size		ECC200		
		Numeric capacity	Alphanum capacity	8-bit byte capacity
Row	Col			
8	18	10	6	3
8	32	20	13	8
12	26	32	22	14
12	36	44	31	20
16	36	64	46	30
16	48	98	72	47

When PDF417 or MicroPDF417 is used, the number of symbol characters called code words is limited to 928 or less. Moreover, the data compression rate varies according to the contents of data. Therefore, the maximum number of digits according to modes is as follows.

When letters and numerics are mixed in data in EXC mode, for example, the maximum values become smaller than the following values, since the internal mode switching code is used.

To correct a reading error by designating the security level, the maximum value becomes smaller, since the error correction code words below are used.

When the number of the code words exceeds 928, or when the number of lines exceeds 90, the symbols are not drawn.

For the MicroPDF417, the numbers of rows and columns can be specified. The maximum number of digits varies according to the setting.

In the case of PDF417

- Extended Alphanumeric Compaction (EXC) mode: 1850 digits
- Binary/ASCII Plus mode: 1108 digits
- Numeric compaction mode: 2000 digits

In the case of MicroPDF417

- Binary mode: 150 digits
- Upper case letter/space mode: 250 digits
- Numeric compaction mode: 366 digits

No. of Error Correction Code Words of PDF417

(For the MicroPDF417, the printer sets the security level automatically.)

Security level	Error Correction Ability	No. of error correction code words
Level 0	<div style="display: flex; flex-direction: column; align-items: center;"> <div style="border: 1px solid black; padding: 5px; margin-bottom: 10px;">Low</div> <div style="border: 1px solid black; padding: 5px; margin-bottom: 10px;">↑</div> <div style="border: 1px solid black; padding: 5px; margin-bottom: 10px;">↓</div> <div style="border: 1px solid black; padding: 5px;">High</div> </div>	0
Level 1		2
Level 2		6
Level 3		14
Level 4		30
Level 5		62
Level 6		126
Level 7		254
Level 8		510

The maximum number of columns and rows for the MicroPDF417

Parameter (gg)	No. of columns	No. of rows	Max. number of digits for binary mode	Max. number of digits for upper case letter/space mode	Max. number of digits for numeric mode
00	–	–	150	250	366
01	1	–	22	38	55
02	2	–	43	72	105
03	3	–	97	162	237
04	4	–	150	250	366
05	1	11	3	6	8
06		14	7	12	17
07		17	10	18	26
08		20	13	22	32
09		24	18	30	44
10		28	22	38	55
11	2	8	8	14	20
12		11	14	24	35
13		14	21	36	52
14		17	27	46	67
15		20	33	56	82
16		23	38	64	93
17		26	43	72	105
18	3	6	6	10	14
19		8	10	18	26
20		10	15	26	38
21		12	20	34	49
22		15	27	46	67
23		20	39	66	96
24		26	54	90	132
25		32	68	114	167
26		38	82	138	202
27		44	97	162	237
28	4	4	8	14	20
29		6	13	22	32
30		8	20	34	49
31		10	27	46	67
32		12	34	58	85
33		15	45	76	111
34		20	63	106	155
35		26	85	142	208
36		32	106	178	261
37		38	128	214	313
38		44	150	250	366

(3) CODE128 code selection

If the case of CODE128 (with auto code selection), code selection is performed in the following manner. (Conforming to USS-128 APPENDIX-G)

- ① Determining the start character
 - (a) If the data begins with four or more consecutive numerals, the start code to be used is (CODE C).
 - (b) In any case other than (a) in ①, if a control character appears before a small letter (see ④.) or four or more consecutive numerals, the start code is (CODE A).
 - (c) In none of the above cases, the start code is (CODE B).
- ② If the data begins with an odd number of digits in (a), ①:
 - (a) Insert the (CODE A) or (CODE B) character just before the last numeric data. When (FNC1), if found in the number, breaks a pair of digits in the number, insert the (CODE A) or (CODE B) character before the numeric data preceding the (FNC1). Selection of (CODE A) or (CODE B) should conform to (b) and (c) in ①.
- ③ If four or more digits of numeric data continue in (CODE A) or (CODE B).
 - (a) When the numeric data is an even number of digits, insert the (CODE C) character just before the first numeric data.
 - (b) When the numeric data is an odd number of digits, insert the (CODE C) character immediately after the first numeric data.
- ④ If a control character appears in (CODE B):
 - (a) In the subsequent data, when a small letter appears before the next control character or four or more consecutive digits, insert the (SHIFT) character before the first control character.
 - (b) When not so, insert the (CODE B) character just before the first control character.
- ⑤ If a small letter appears in (CODE A):
 - (a) In the subsequent data, when a control character appears before the next small letter or four or more consecutive digits, insert the (SHIFT) character before the first small letter.
 - (b) When not so, insert the (CODE B) character just before the first small letter.
- ⑥ If any data other than the numerals appears in (CODE C):
 - (a) Insert the (CODE A) or (CODE B) character just before the data other than the numerals. Selection of (CODE A) or (CODE B) should conform to (b) and (c) in ①.

(4) CODE128 code selection check

Check if selection of (CODE A), (CODE B), or (CODE C) of CODE128 has been set correctly. If an error is found, the bar code will not be drawn.

[Conditions causing an error]

- ① No start code is designated.
- ② A small letter (including { , | , } , ~ , _) is found in (CODE A).
- ③ A control character is found in (CODE B).
- ④ Any data other than the numerals, (FNC1), (CODE A), and (CODE B) is found in (CODE C).
- ⑤ There are two or more consecutive (SHIFT) characters.
- ⑥ The number in (CODE C) is an odd number of digits.
- ⑦ (SHIFT) is followed by (CODE A), (CODE B) or (CODE C).

(5) Kanji code selection

- In the case of Data Matrix and PDF417, Kanji codes can be printed. Shift JIS, JIS hexadecimal, JIS 8 codes can be mixed.

(6) Link field data string

- After the link field No. is designated in the Format Command, data strings are linked using the Link Field Data Command to draw an image.
- Up to 2000 digits of data strings of Data Matrix and PDF417 can be linked. For other bar codes, up to 126 digits can be linked. (The value varies according to the type of bar code.)
When the number of digits exceeds the maximum value, excess data will be discarded.
- Up to 99 data strings can be linked.
- Up to 2048 bytes can be used as the command length ([ESC] to [NUL]) of the Link Field Data Command.
- When the data string is omitted in the Link Field Data Command, the following process is performed:
 - ① No process will be performed for the field which contains no print data due to the omission.
 - ② When the field partially loses print data due to the omission, the only remaining data will be processed as print data.
- The Link Field Data Command can be used for the bit map font fields, outline font fields, and bar code fields.
(The same result is obtained when any of the “RC,” “RV”, or “RB” command code is designated.)

(7) When manual mode is selected in the Format Command for a QR code

① Numeric mode, alphanumeric and symbol mode, Kanji mode

Mode selection	Data to be printed
----------------	--------------------

② Binary mode

Mode selection	No. of data strings (4 digits)	Data to be printed
----------------	-----------------------------------	--------------------

③ Mixed mode

Data	“,” (comma)	Data	“,” (comma)	Data
------	-------------	------	-------------	------

The QR code can handle all codes including alphanumerics, symbols and Kanji. Since data compression rate varies according to codes, the code to be used is designated when the mode is selected.

Mode	Code	Details
N	Numerals	0 to 9
A	Alphanumerics, symbols	A to Z 0 to 9 space \$ % * + - . / :
B	Binary (8-bit)	00H to FFH
K	Kanji	Shift JIS, JIS hexadecimal

If mixed mode is selected, up to 200 modes can be selected in a QR code.

(8) When the automatic mode is selected in the Format Command for a QR code.

Data to be printed

(9) How to transmit the control code data

NUL (00H)	=	> @ (3EH, 40H)
SOH (01H)	=	> A (3EH, 41H)
STX (02H)	=	> B (3EH, 42H)
⋮		
GS (1DH)	=	>] (3EH, 5DH)
RS (1EH)	=	> ^ (3EH, 5EH)
US (1FH)	=	> _ (3EH, 5FH)

* How to transmit the special codes

> (3EH)	=	> 0 (3EH, 30H)
---------	---	----------------

(10) Transfer code for QR code

	0	1	2	3	4	5	6	7	8	9	A	B	C	D	E	F
0	NUL	DLE	SP	0	@	P	`	p								
1	SOH	DC1	!	1	A	Q	a	q								
2	STX	DC2	"	2	B	R	b	r								
3	ETX	DC3	#	3	C	S	c	s								
4	EOT	DC4	\$	4	D	T	d	t								
5	ENQ	NAK	%	5	E	U	e	u								
6	ACK	SYN	&	6	F	V	f	v								
7	BEL	ETB	'	7	G	W	g	w								
8	BS	CAN	(8	H	X	h	x								
9	HT	EM)	9	I	Y	i	y								
A	LF	SUB	*	:	J	Z	j	z								
B	VT	ESC	+	;	K	[k	{								
C	FF	FS	,	<	L	\	l									
D	CR	GS	-	=	M]	m	}								
E	SO	RS	•	>	N	^	n	~								
F	SI	US	/	?	O	_	o	DEL								

* The shaded parts are Japanese. They are omitted here.

(11) Examples of data designation

① Alphanumeric mode: ABC123

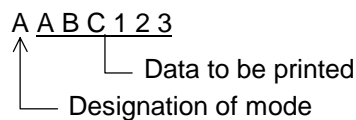

② Binary mode: 01H, 03H, 05H

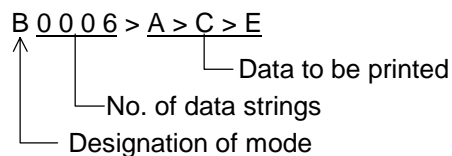

③ Mixed mode

Numeric mode : 123456
 Kanji mode : Kanji data
 Binary mode : aア iイ uウ eエ oオ
 Alphanumeric mode : ABC

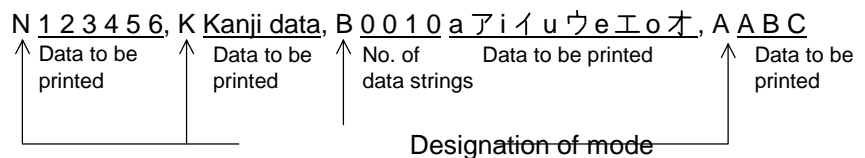

④ Automatic mode

When the data above (③) is designated in automatic mode:

1 2 3 4 5 6 Kanji data aア iイ uウ eエ oオ A B C
 Data to be printed

(12) MaxiCode data

For mode 0 or 1:

[ESC] RBaa; bbbbbbbbbbccdddeeeeee --- eeeee [LF] [NUL]

For mode 2 or 3:

[ESC] RBaa; bbbbbbbbbbccdddeeeeee --- eeeee [LF] [NUL]

For mode 4 or 6:

[ESC] RBaa; ffffffffggggg --- ggggg [LF] [NUL]

- | | | | |
|---|----------------|--------------------------------|---|
| ① | bbbbbbbbb: | Postal code | Fixed as 9 digits |
| | • Mode 0 or 2: | | |
| | b1b2b3b4b5: | Zip code | Fixed as 5 digits (Numerics) |
| | b6b7b8b9: | Zip code extension | Fixed as 4 digits (Numerics) |
| | • Mode 1 or 3: | | |
| | b1b2b3b4b5b6: | Zip code | Fixed as 6 digits (Character "A" of code set) |
| | b7b8b9: | Vacant | Fixed as 3 digits (20H) |
| ② | ccc: | Class of service | Fixed as 3 digits (Numerics) |
| ③ | ddd: | Country code | Fixed as 3 digits (Numerics) |
| ④ | eee --- eee: | Message data strings | 84 digits |
| ⑤ | fffffff: | Primary message data strings | 9 digits |
| ⑥ | ggg --- ggg: | Secondary message data strings | 84 digits |

- NOTES:**
1. When anything other than numerics is included in the data string of zip code (mode 2), zip code extension, class of service or country code, a MaxiCode is not drawn.
 2. If the message data is less than 84 digits when mode 2 or 3 is selected, the printer adds a CR (000000) at the end of the data, and the remaining digits will be padded with FSs (011100). When message data exceeding 84 digits is received, the excess data will be discarded before drawing a MaxiCode.
 3. If the message data is less than 93 digits (9 digits + 84 digits) when mode 4 or 6 is selected, the printer adds a CR (000000) at the end of the data, and the remaining digits will be padded with FSs (011100). When message data exceeding 93 digits is received, the excess data will be discarded before drawing a MaxiCode.
 4. Mode 6 should not be used for usual operation since it is used for scanner programming.

Examples

(1)

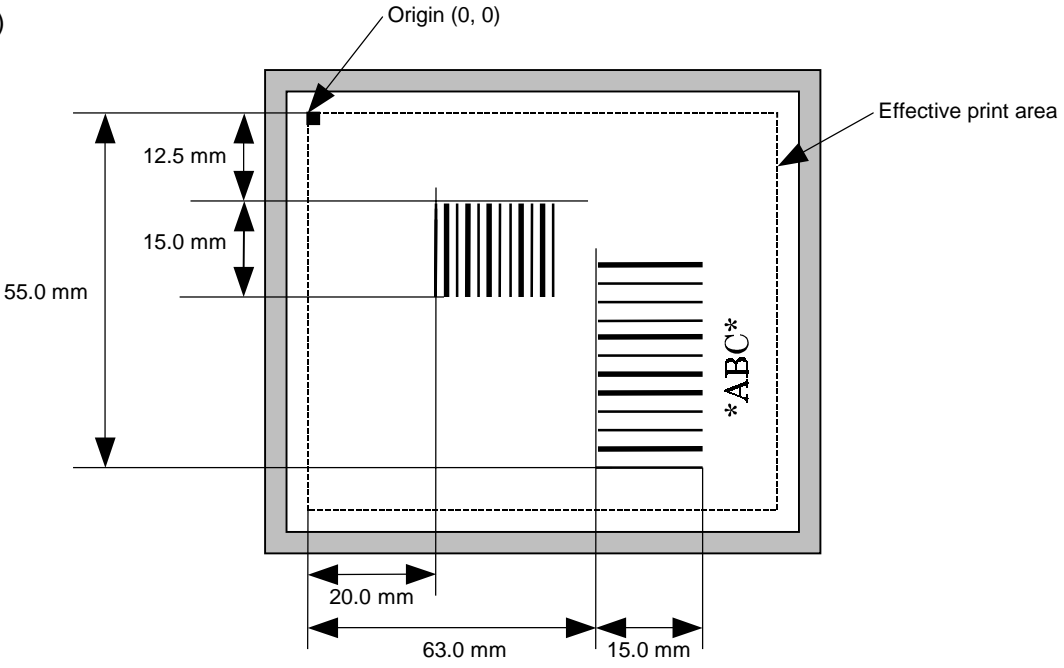

```
[ESC] C [LF] [NUL]  
[ESC] XB01; 0200, 0125, 3, 1, 02, 02, 06, 06, 02, 0, 0150 [LF] [NUL]  
[ESC] XB02; 0830, 0550, 3, 1, 02, 04, 07, 08, 04, 3, 0150, +0000000000, 1, 00, N [LF] [NUL]  
[ESC] RB01; 12345 [LF] [NUL]  
[ESC] RB02; *ABC* [LF] [NUL]  
[ESC] XS; I, 0002, 0002C3000 [LF] [NUL]
```

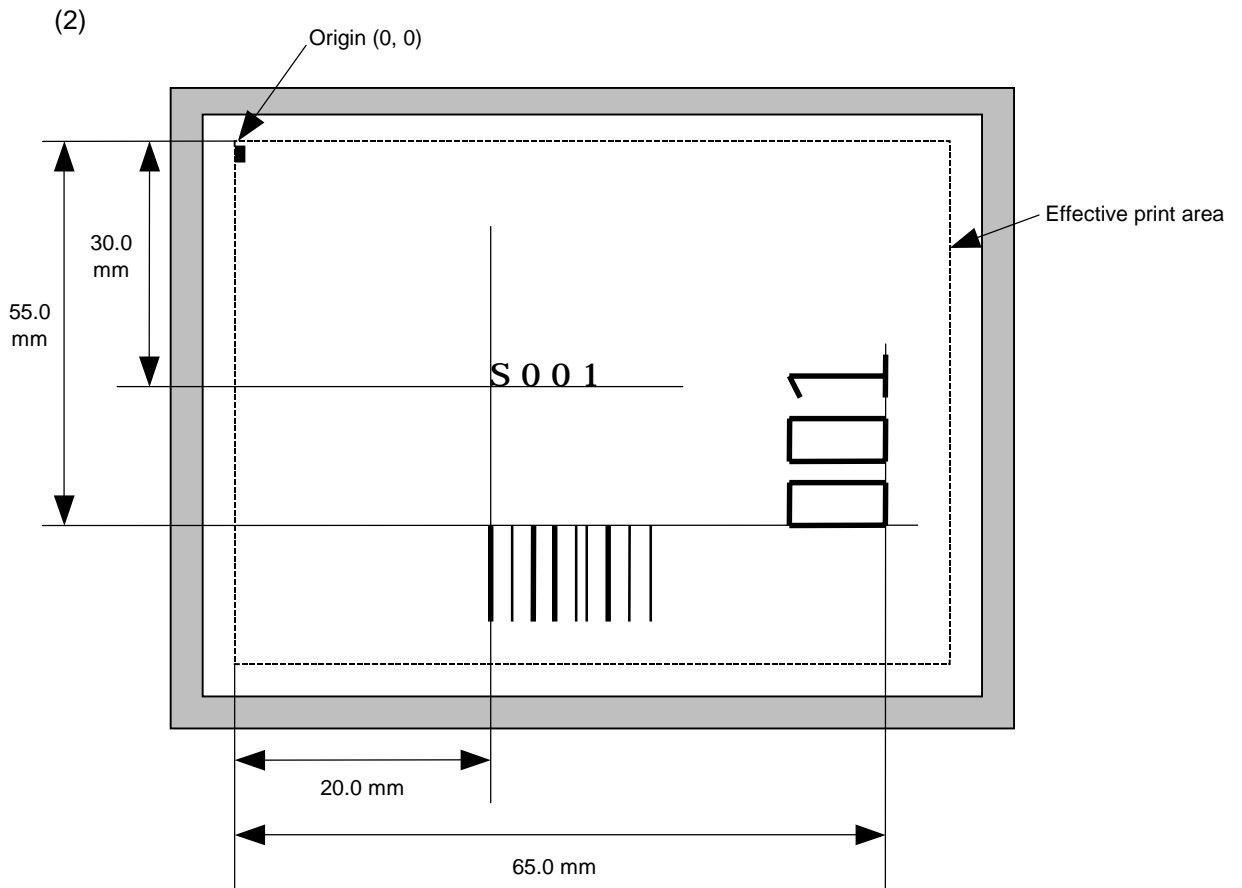

```
[ESC] C [LF] [NUL]
[ESC] PC001; 0200, 0300, 1, 1, C, 00, B; 01, 02 [LF] [NUL]
[ESC] PV01; 0650, 0550, 0200, 0150, B, 33, B; 02 [LF] [NUL]
[ESC] XB01; 0200, 0550, 3, 1, 02, 02, 06, 06, 02, 0, 0150; 01, 02 [LF] [NUL]
[ESC] RB; S [LF] 001 [LF] [NUL]
[ESC] XS; I, 0002, 0002C3000 [LF] [NUL]
```

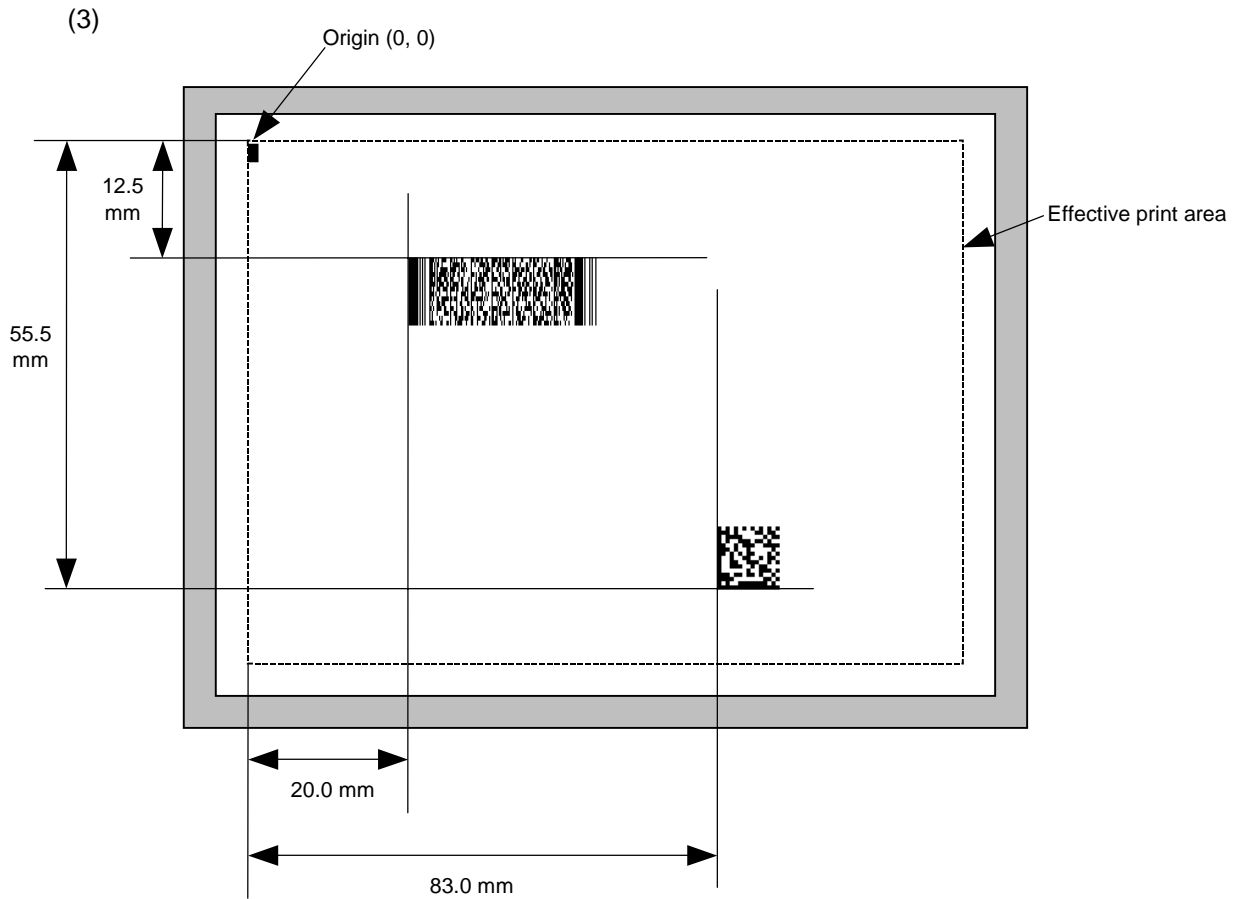

```
[ESC] C [LF] [NUL]
[ESC] XB01; 0200, 0125, P, 04, 02, 03, 0, 0010 [LF] [NUL]
[ESC] XB02; 0830, 0550, Q, 08, 04, 05, 3 [LF] [NUL]
[ESC] RB01; PDF417 [LF] [NUL]
[ESC] RB02; Data Matrix [LF] [NUL]
[ESC] XS; I, 0002, 0002C3000 [LF] [NUL]
```

6.3.13 ISSUE COMMAND

[ESC] XS

Function	Issues labels according to the print conditions programmed.
Format	[ESC] XS; l, aaaa, bbbcddefgh [LF] [NUL]
Term	<p>aaaa: Number of labels to be issued 0001 to 9999</p> <p>bbb: Cut interval. Designates the number of pieces to be printed before the backing paper is cut. 000 to 100 (no cut when 000)</p> <p>c: Type of sensor 0: No sensor 1: Reflective sensor 2: Transmissive sensor (when using normal labels) 3: Transmissive sensor (when using normal labels) 4: Reflective sensor</p> <p>d: Issue mode C: Batch mode D: Strip mode (with back feed, the strip sensor is valid.) E: Strip mode (with back feed, the strip sensor is ignored, the applicator supports this mode.) F: Partial cut mode (Non back feed cut mode)</p> <p>e: Issue speed 1: 2 inches/sec 2: 2 inches/sec 3: 3 inches/sec 4: 4 inches/sec 5: 5 inches/sec 6: 5 inches/sec 7: 5 inches/sec 8: 5 inches/sec 9: 5 inches/sec A: 5 inches/sec</p> <p>f: With/without ribbon Ignore</p> <p>g: Designates tag rotation. 0: Printing bottom first 1: Printing top first 2: Mirror printing bottom first 3: Mirror printing top first</p> <p>h: Type of status response 0: No status response 1: Status response</p>

Explanation

(1) Number of labels to be issued

- ① If increment/decrement is not specified, the designated number of pieces with the same drawing data will be issued.
- ② If increment /decrement is specified, the designated number of pieces will be issued while incrementing/decrementing the piece of the designated drawing area.
 - * The increment/decrement designation is valid until the Image Buffer Clear Command ([ESC] C) is transmitted.

(2) Cut interval

The cut interval is valid only when the cutter has been installed and the issue mode is "C". If an error occurs during an issue after the cut interval is designated, and then printing is restarted, the printer ejects the printed paper then resumes printing on the paper where the error occurred.

If no subsequent command is received from the PC for 3 seconds after cut-issuing the last label, when the cut interval is valid and "with automatic forward feed standby" set in the system mode, the printer automatically performs a 10-mm forward feed.

When the Issue Command is received during the automatic forward feed standby, an issue is started after a reverse feed to the original position.

If any command is sent and processed after the Issue Command is sent, the automatic forward feed is not performed. Therefore, a command should not be sent after the Issue Command is sent. If the power should not be turned off then on, or the printer should not be placed in a pause/reset state before the automatic forward feed, since the automatic forward feed is not performed when the paper is fed by turning the power off then on, or by pressing the [FEED] key of the printer in the pause/reset state.

If the paper is fed by pressing the [FEED] key of the printer during the forward feed standby, the printer feeds one label, cuts, performs the automatic forward feed then stops.

(3) Type of sensor

- ① No sensor: Printing takes place according to the parameter designated by the Label Size Set Command.
- ② Reflective sensor:

Printing takes place according to the parameter designated by the Label Size Set Command. However, the black mark provided on the back side of the tag paper is automatically sensed by the reflective sensor and the paper position is finely adjusted for every piece.
- ③ Transmissive sensor (when using normal labels):

Printing takes place according to the parameter designated by the Label Size Set Command. However, the label-to-label gap is automatically sensed by the transmissive sensor and the paper position is finely adjusted for every piece.

(4) Issue mode

[C: Batch mode (cut interval 0)]

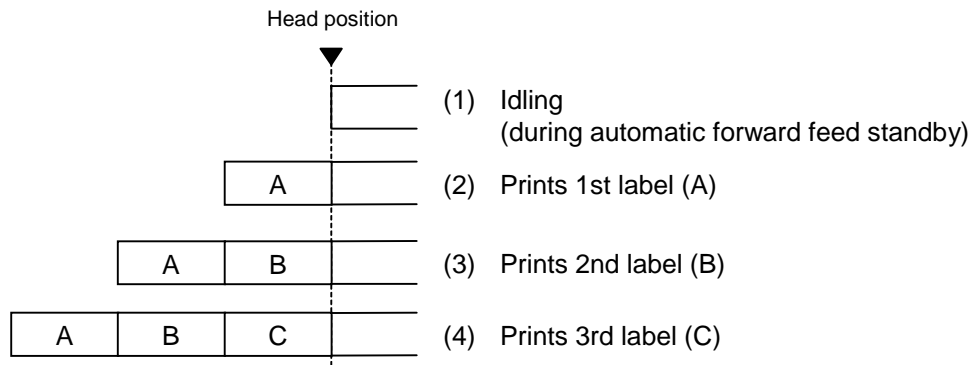

[C: Batch mode (Cut interval: 1, Issue count: 2)]

“Without automatic forward feed standby” selected in the system mode

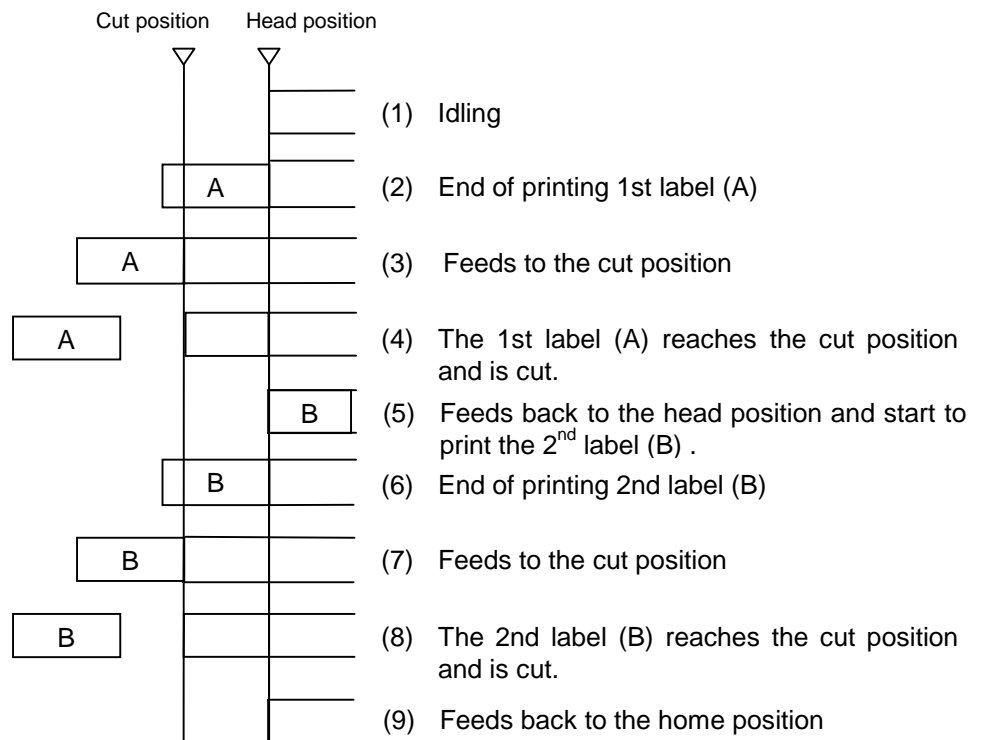

[C: Batch mode (Cut interval: 1, Issue count: 2)]

“With automatic forward feed standby” selected in the system mode

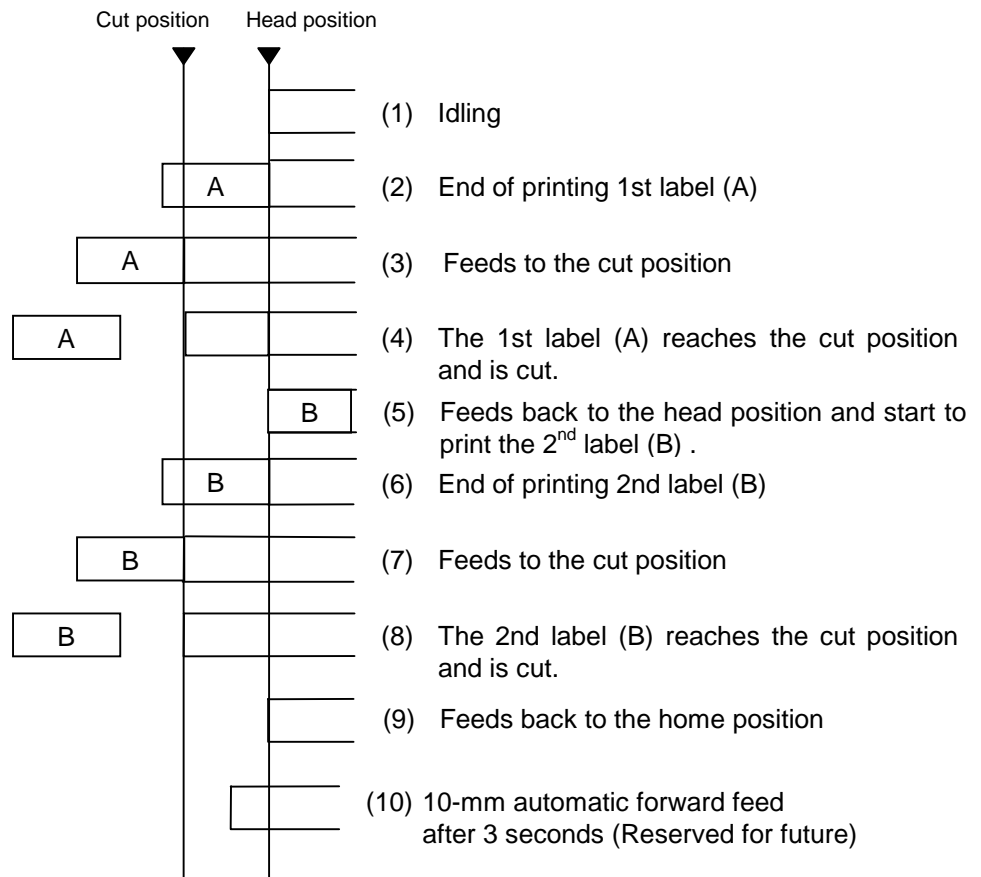

[D: Strip mode (Issue count: 3)]

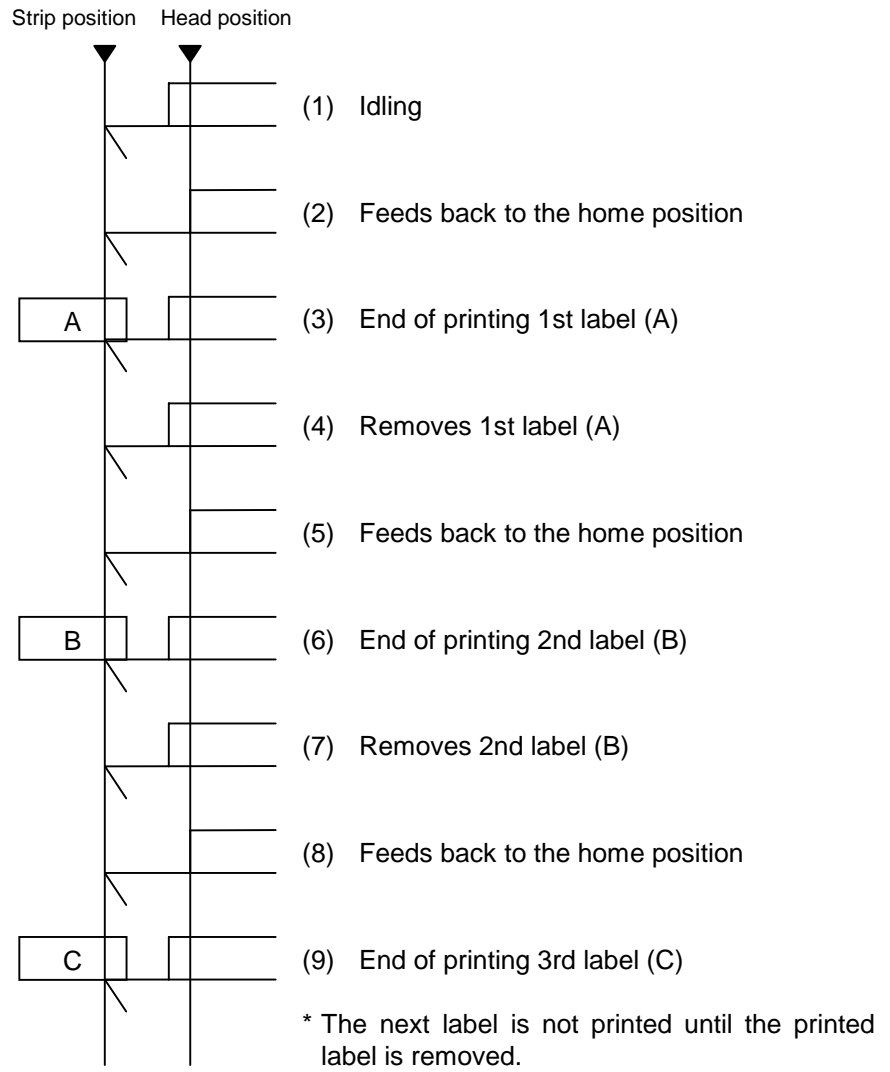

(5) Issue speed

- Printing takes place at the designated speed.
- The possible issue speed varies according to types and sizes of the paper supply. For details, refer to the Supply Specification.

Model	B-SV4D
Parameter	
1	
2	2"/sec
3	3"/sec
4	4"/sec
5	5"/sec
6	
7	
8	
9	
A	

(6) Tag rotation

The origin of coordinates and printing direction vary according to the designation of tag rotation.

① Printing bottom first

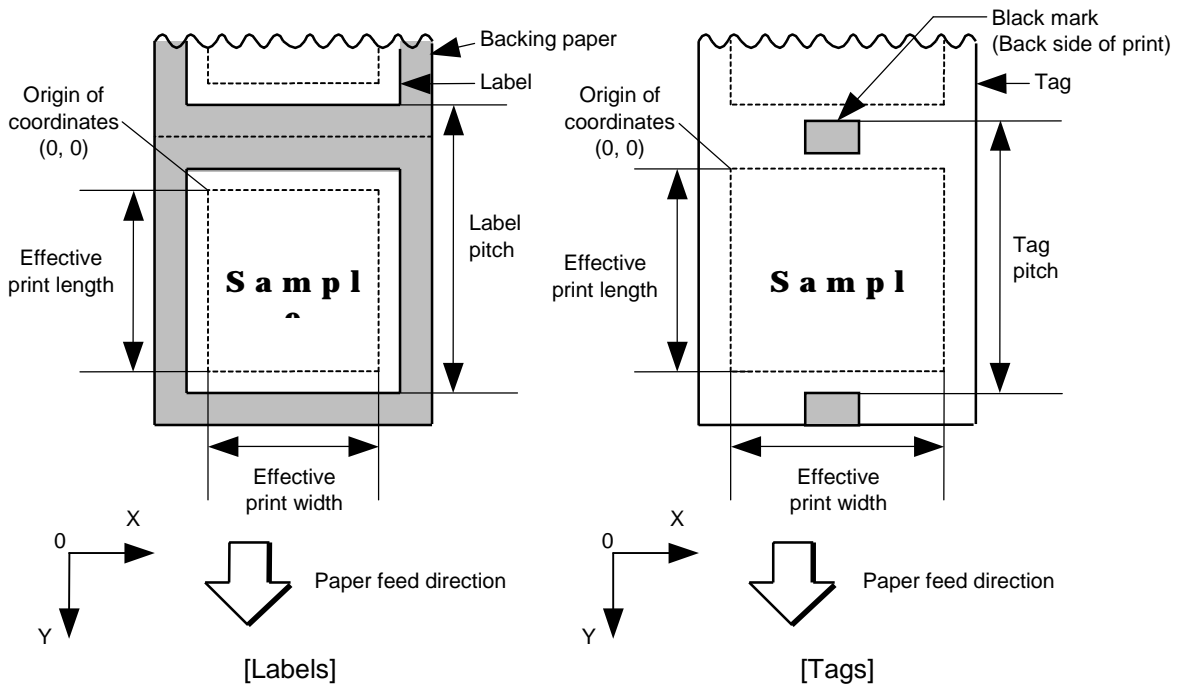

② Printing top first

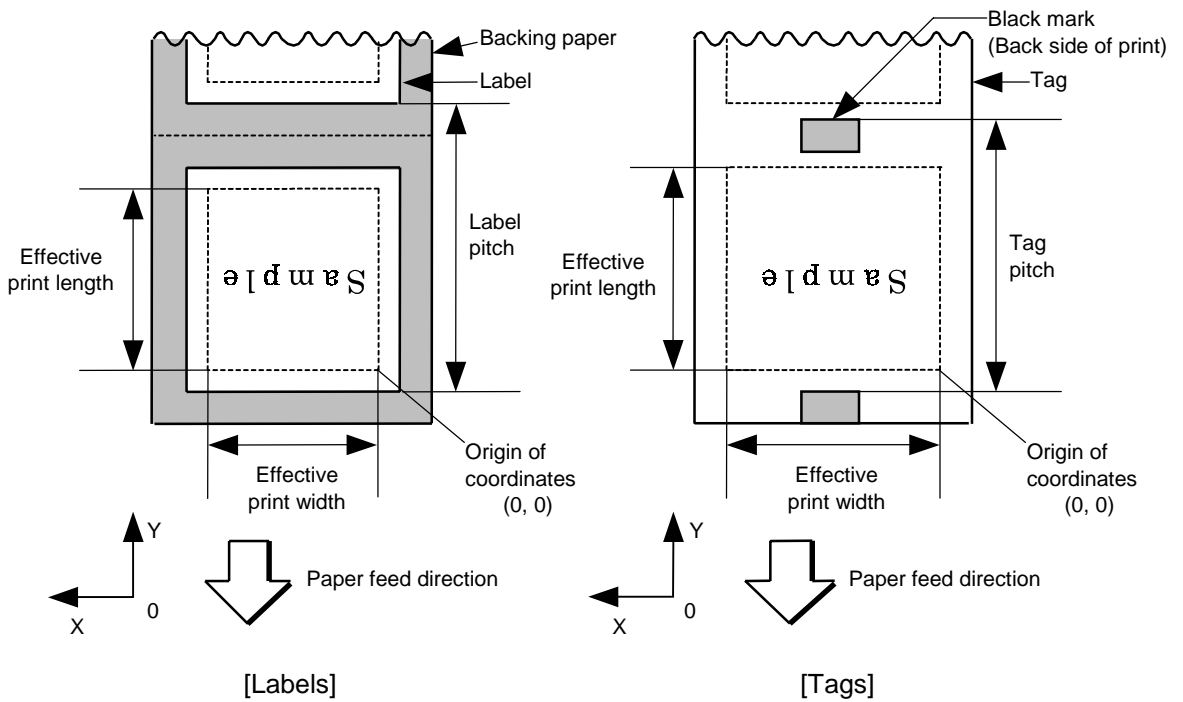

③ Mirror printing bottom first

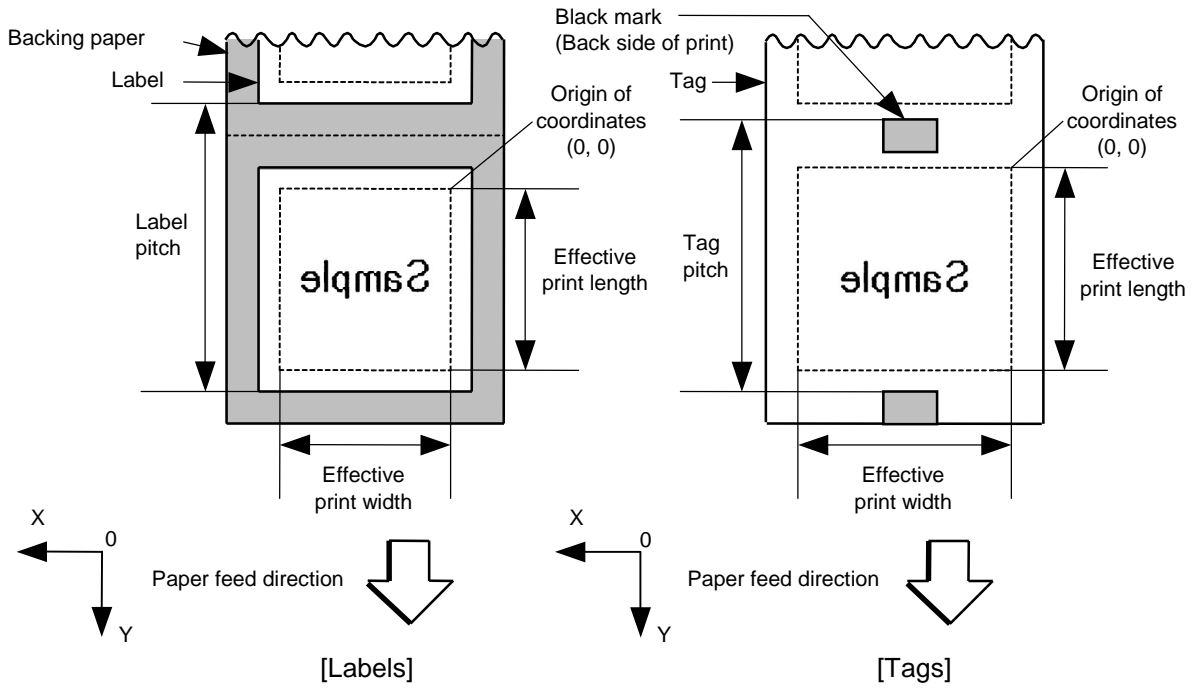

④ Mirror printing top first

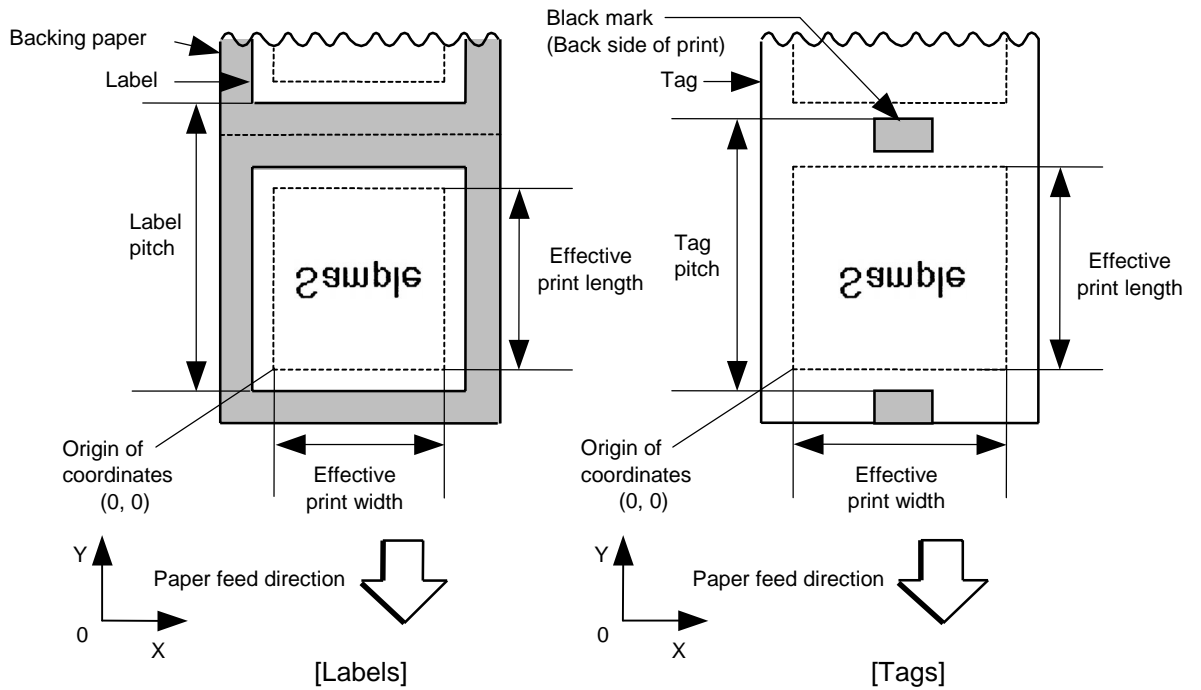

(7) Status response

When the option with status response has been selected, a status response is made at the end of printing or if an error occurs.

In batch mode and cut mode, the print end status response is made after printing on the designated number of labels.

In strip mode, the status response is made after printing one label.

* Do not change the parameter for status response/no status response during printing. Otherwise the status response may not be performed properly.

Examples

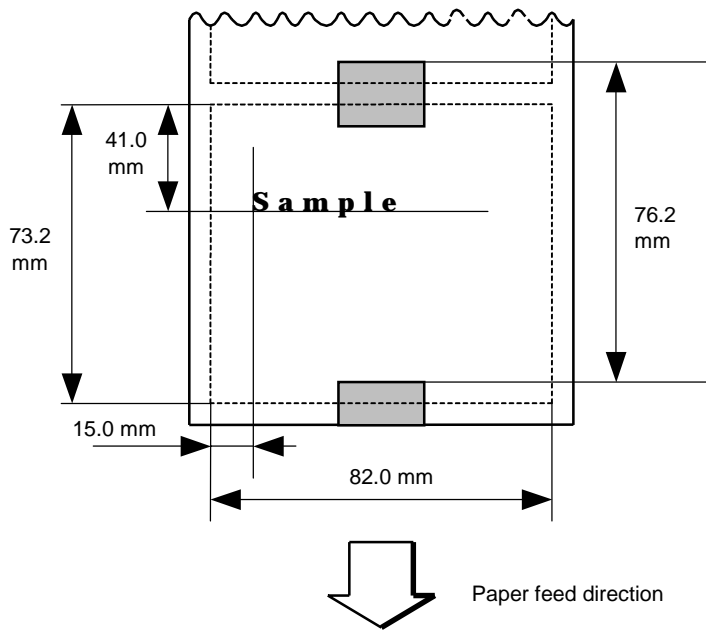

- Issue count: 4 pieces
- Cut interval: 1 piece
- Paper: Tag paper (Reflective sensor used)
- Issue mode: Cut issue
- Issue speed: 8"/sec.
- Ribbon: With
- Status response: On

```
[ESC] D0762, 0820, 0732 [LF] [NUL]  
[ESC] T11C30 [LF] [NUL]  
[ESC] C [LF] [NUL]  
[ESC] PC001; 0150, 0410, 1, 1, A, 00, B [LF] [NUL]  
[ESC] RC001; Sample [LF] [NUL]  
[ESC] XS; I, 0004, 0011C8201 [LF] [NUL]
```

Notes

- (1) Explanation of processes involved to stop the label at the home position after the head-open state is detected:

When the gap between labels (black mark) is found after the head open state is detected, the value to stop at the home position of each label between the head and the sensor is set again.

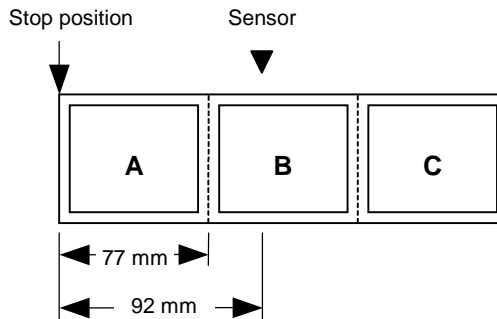

- The paper is moved in the above state.

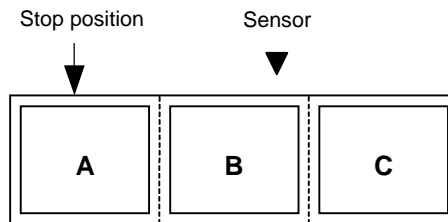

- Stop position after feeding one label

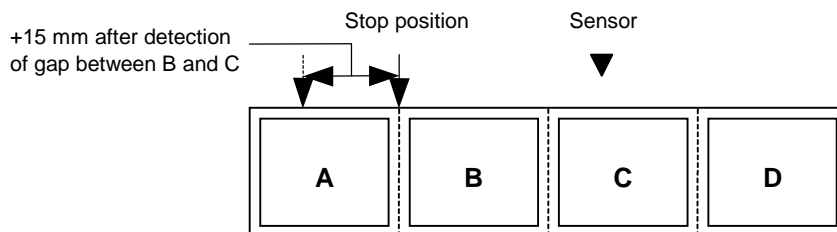

* However, an error will result when feed jam conditions are met.

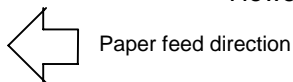

- (2) Any cut or strip issue commands should not be sent to the printer on which the cutter or strip module is not installed.

6.3.14 FEED COMMAND

[ESC] T

Function	Feeds the paper.
Format	[ESC] Tabcde [LF] [NUL]
Term	<p>a: Type of sensor 0: No sensor 1: Reflective sensor 2: Transmissive sensor (when using normal labels) 3: Transmissive sensor (when using normal labels) 4: Reflective sensor</p> <p>b: Selects cut or non-cut 0: Non-cut 1: Cut</p> <p>c: Feed mode C: Batch mode (Cut and feed when "Cut" is selected for parameter b.) D: Strip mode (with back feed) E: Strip mode (Reserved for future) F: Partial cut mode (Non back feed cut mode)</p> <p>d: Feedspeed 1: 2 inches/sec 2: 2 inches/sec 3: 3 inches/sec 4: 4 inches/sec 5: 5 inches/sec 6: 5 inches/sec 7: 5 inches/sec 8: 5 inches/sec 9: 5 inches/sec A: 5 inches/sec</p> <p>e: With/without ribbon Ignore</p>

Explanation	<p>(1) Type of sensor</p> <p>① No sensor: Feeding takes place according to the parameter designated by the Label Size Set Command.</p> <p>② Reflective sensor: Feeding takes place according to the parameter designated by the Label Size Set Command. However, the black mark provided on the back side of the tag paper is automatically sensed by the reflective sensor and the stop position is finely adjusted.</p> <p>③ Transmissive sensor (when using normal labels): Feeding takes place according to the parameter designated by the Label Size Set Command. However, the label-to-label gap is automatically sensed by the transmissive sensor and the stop position is finely adjusted.</p>
-------------	--

④ Transmissive sensor (when using preprinted labels):

Feeding takes place according to the parameter designated by the Label Size Set Command. However, the label-to-label gap is automatically sensed by the transmissive sensor and the stop position is finely adjusted according to the value set by the threshold set operation (key operation).

⑤ Reflective sensor (when using a manual threshold value)

Feeding takes place according to the parameters designated by the Label Size Set Command. However, the black mark provided on the back of the tag paper is automatically sensed by the reflective sensor and the paper position is finely adjusted for every piece, according to the value set by the threshold set operation (key operation).

(2) Cut/non-cut

This option is valid in batch feed mode only. (Non-cut is selected in strip mode.) If no subsequent command is received from the PC for 3 seconds after cut-feeding when “with automatic forward feed standby” is set in the system mode, the printer automatically performs a 10-mm forward feed. When the Feed Command is received in the forward feed standby state, the printer performs a reverse feed to the original position.

* For notes, refer to the section regarding the Issue Command.

For cutting the label having label pitch of 38 mm or less, refer to the section regarding the Position Fine Adjustment Command.

(3) Feed mode

[C: Batch (Non-cut)]

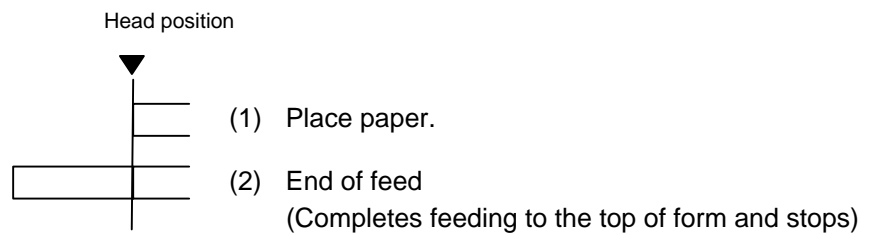

[C: Batch (Cut)]

“Without automatic forward feed standby” selected in the system mode.

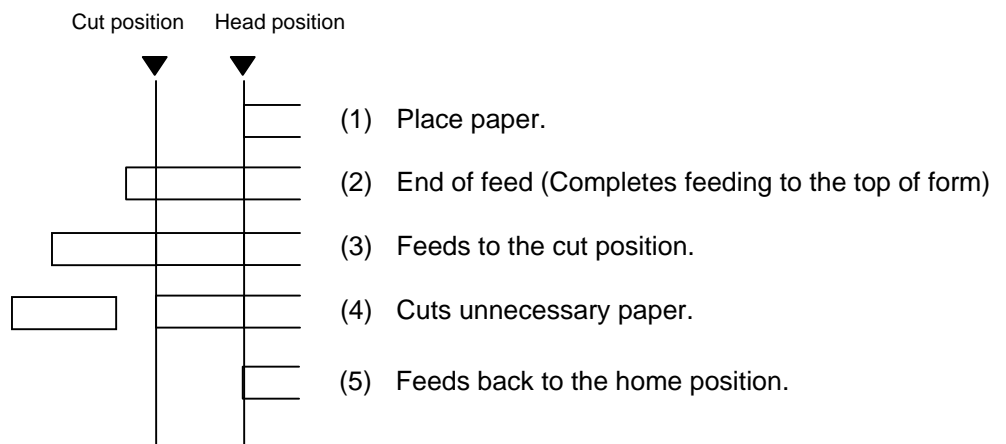

[C: Batch (Cut)]

“With automatic forward feed standby” selected in the system mode.

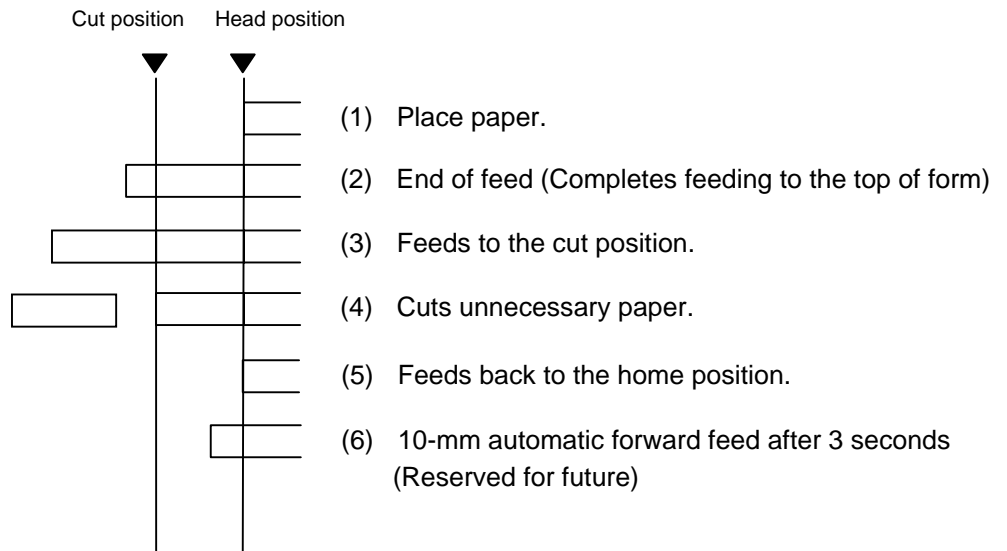

[D: Strip]

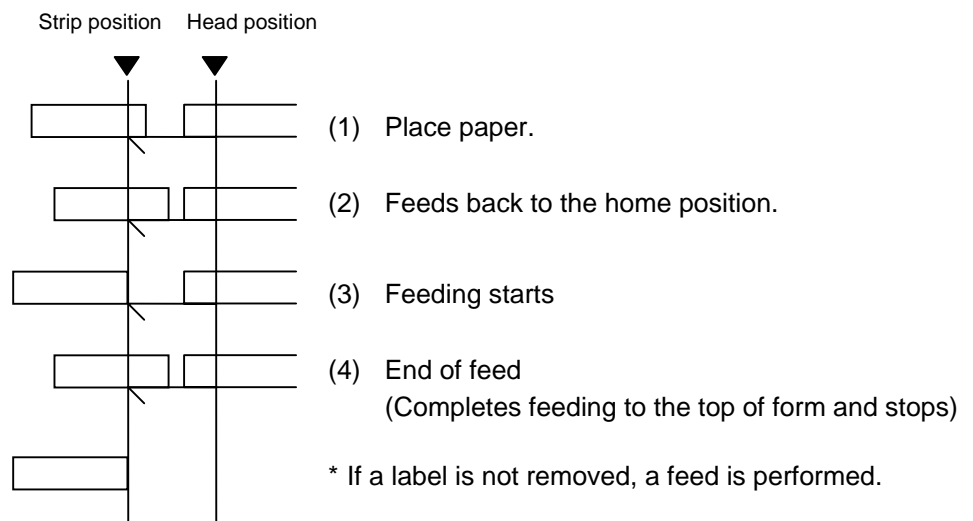

[F: Partial cut mode]

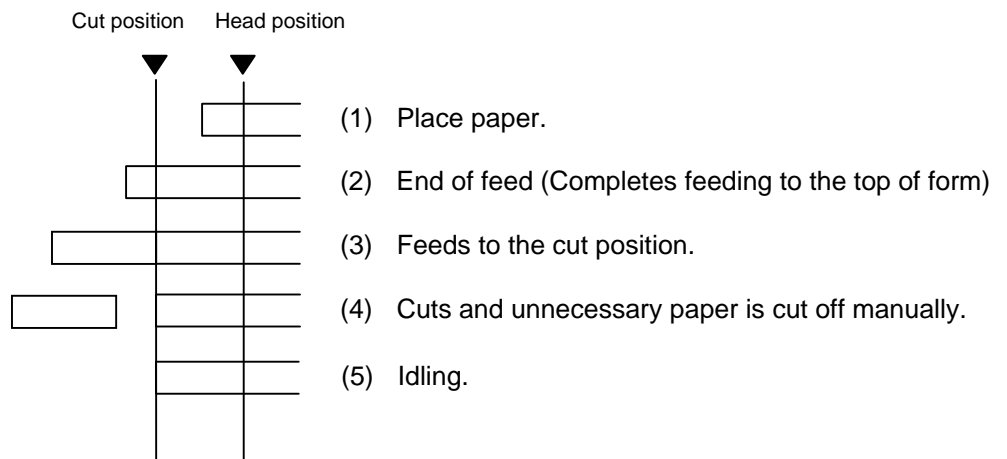

(4) Feed speed

- A feed is performed at the designated speed.
However, the back feed speed in the cut mode or the strip mode is 3"/sec.
- The possible issue speed varies according to types and sizes of the paper supply.
For details, refer to the Supply Specification.

Model	B-SV4D
Parameter	
1	
2	2"/sec
3	3"/sec
4	4"/sec
5	5"/sec
6	
7	
8	
9	
A	

Notes

- (1) If a change of label size or type of sensor, feed fine adjustment, cut position fine adjustment (or strip position fine adjustment) or back feed fine adjustment is made, one label must be fed to adjust the first print position prior to printing.
- (2) The parameter of the Feed Command is protected in memory (even if the power is turned off).
- (3) When "status response made" is selected in the Issue Command parameter setting, a status response is made after the end of feed or when an error occurs.
- (4) For explanation about the process to stop the label at the home position, refer to the section regarding the Issue Command.
- (5) If no subsequent command is received from the PC after the last label has been fed, the printer automatically performs a 14.7-mm forward feed is selected and "with automatic forward feed standby" is selected in the system mode. When the Feed Command is received during the forward feed standby, the printer feeds the label in reverse to the original position.
* For notes, refer to the section regarding the Issue Command.

Examples

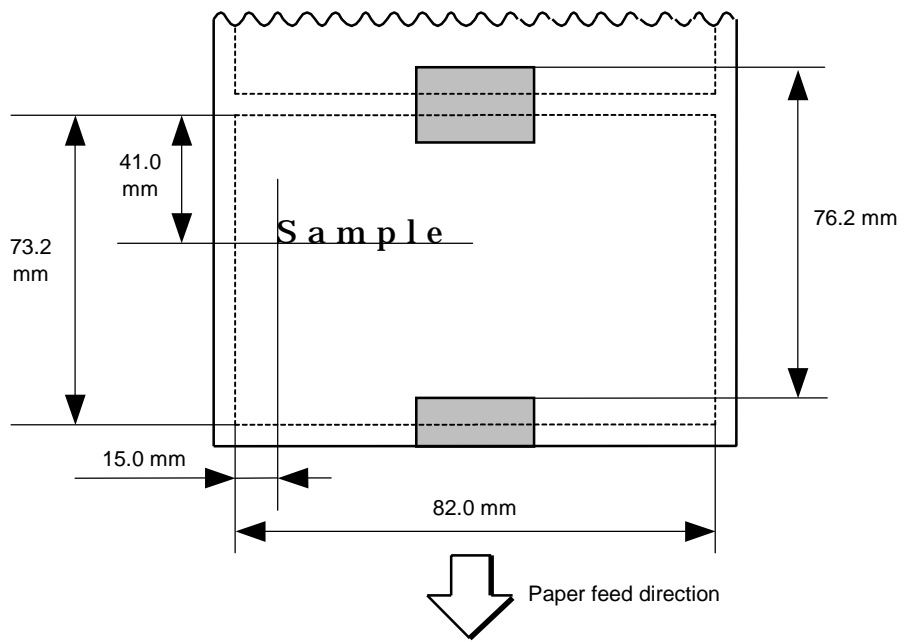

[ESC] D0762, 0820, 0732 [LF] [NUL]
[ESC] AX; +010, +000, +10 [LF] [NUL]
[ESC] T11C30 [LF] [NUL]
[ESC] C [LF] [NUL]
[ESC] PC001; 0150, 0410, 1, 1, A, 00, B [LF] [NUL]
[ESC] RC001; Sample [LF] [NUL]
[ESC] XS; I, 0004, 0011C3001 [LF] [NUL]

6.3.15 EJECT COMMAND

[ESC] IB

Function Ejects (cuts) the label presently remaining between the head and the cutter and returns to the original position.

Format [ESC] IB [LF] [NUL]

Notes If no subsequent command is received from the PC for 3 seconds after ejection, the printer automatically performs a 10-mm forward feed when “with automatic forward feed standby” is selected in the system mode.
When the Eject Command is received in the forward feed standby state, the printer feeds the label in reverse to the original position and ejects it.

* For notes, refer to the section regarding the Issue Command.

Examples

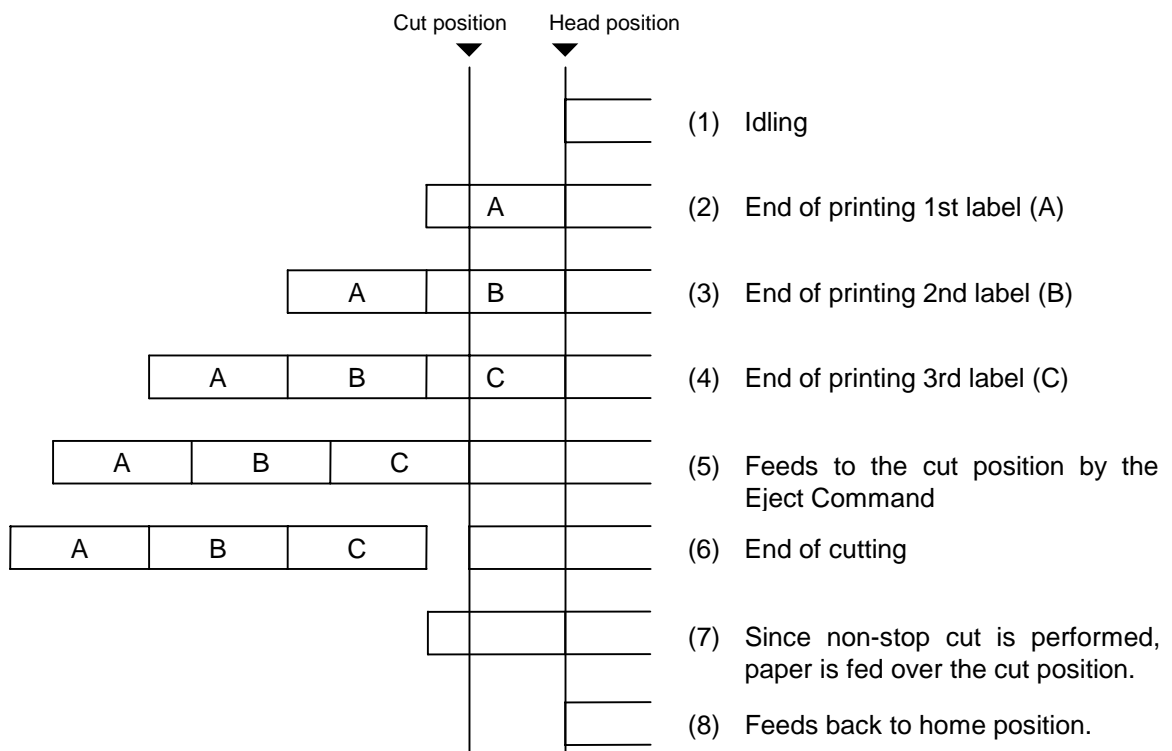

```
[ESC] C [LF] [NUL]
[ESC] PC001; 0200, 0125, 1, 1, A, 00, B [LF] [NUL]
[ESC] RC001; A [LF] [NUL]
[ESC] XS; I, 0001, 0001C3001 [LF] [NUL]
[ESC] RC001; B [LF] [NUL]
[ESC] XS; I, 0001, 0001C3001 [LF] [NUL]
[ESC] RC001; C [LF] [NUL]
[ESC] XS; I, 0001, 0001C3001 [LF] [NUL]
[ESC] IB [LF] [NUL]
```

6.3.16 FORWARD/REVERSE FEED COMMAND

[ESC] U1, [ESC] U2

Function	After printing or feeding the paper, feeds the paper to a manually cut position. When issuing the next label, feeds the paper back to the first printing position.
Format	Forward Feed [ESC] U1; aaaa [LF] [NUL] Reverse Feed [ESC] U2; aaaa [LF] [NUL]
Term	aaaa: Feed value by which the paper is fed forward or backward. 0030 to 2000 (in 0.1 mm units)
Notes	(1) When the [FEED] key is pressed on the printer, one label is fed, and then fed by the forward feed value automatically if the Forward Feed Command has already been transmitted. (2) The Forward/Reverse Feed Command is protected in memory (even if the power is turned off). (3) The Forward/Reverse Feed Command is ignored in strip mode and cut issue mode. (4) The forward feed is performed at the speed designated in the Issue Command or Feed Command.

Examples

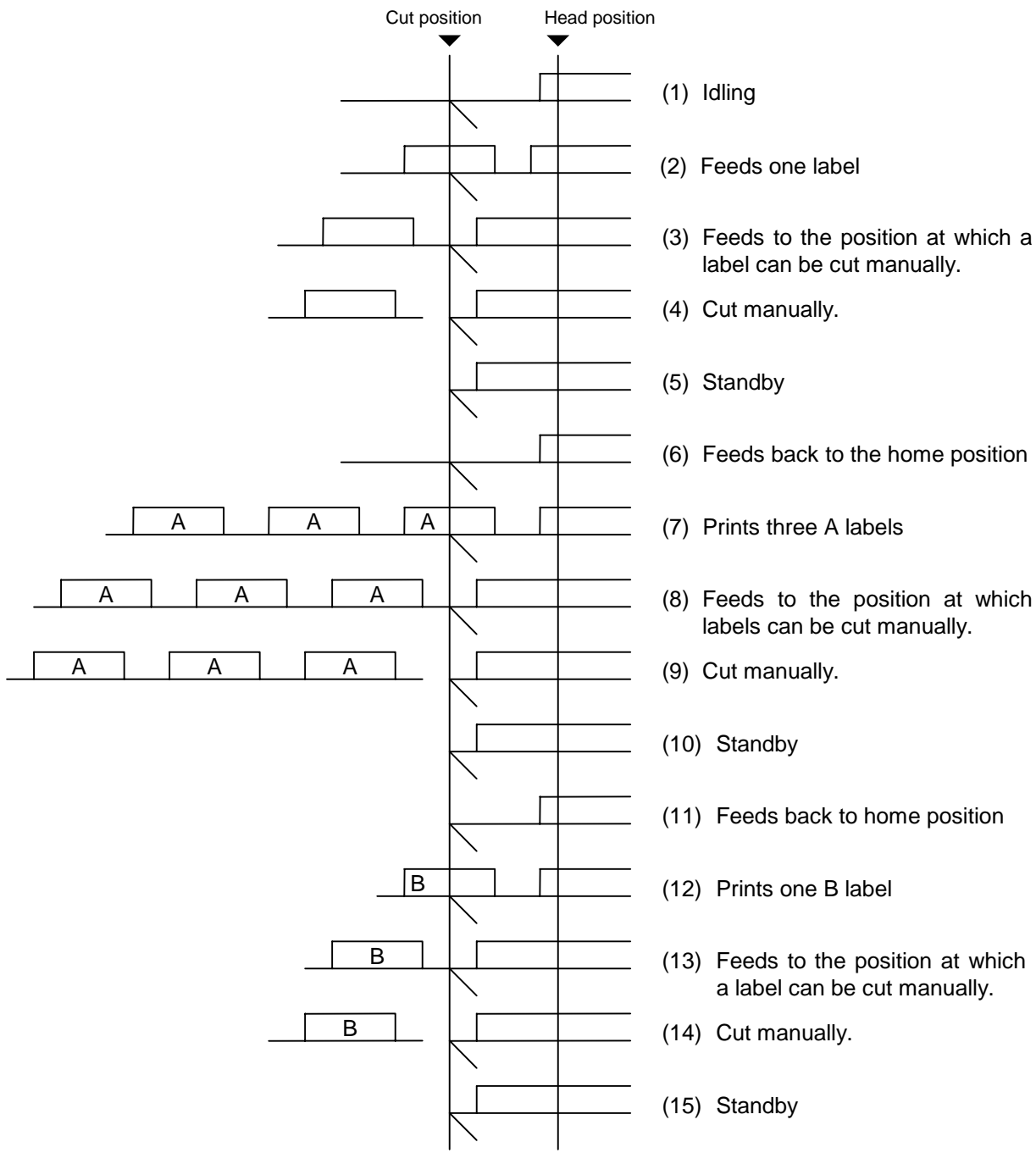

```
[ESC] T20C30 [LF] [NUL]
[ESC] U1; 0120 [LF] [NUL]
    Cut manually.
[ESC] U2; 0120 [LF] [NUL]
[ESC] RC001; A [LF] [NUL]
[ESC] XS; I, 0003, 0002C3001 [LF] [NUL]
[ESC] U1; 0120 [LF] [NUL]
    Cut manually.
[ESC] U2; 0120 [LF] [NUL]
[ESC] RC001; B [LF] [NUL]
[ESC] XS; I, 0001, 0002C3001 [LF] [NUL]
[ESC] U1; 0120 [LF] [NUL]
```

6.3.17 STORAGE AREA ALLOCATE COMMAND

[ESC] XF

Function	Allocates the storage area in flash ROM on the CPU board.
Format	[ESC] XF; aa, bb [, cc] [, Ed] [LF] [NUL]
Term	<p>aa: Size of the TrueType font storage area 00 to 03 (0 KB to 192 KB) (in units of 64 KB)</p> <p>bb: Size for bit map writable character storage area 00 to 03 (0 KB to 192 KB) (in units of 64 KB)</p> <p>cc: Size for BASIC file storage area 00 to 03 (0 KB to 192 KB) (in units of 64 KB)</p> <p>Ed: Indicates where the upper files are stored. d: 0: Flash ROM on the CPU board 1: Flash ROM on the memory board (Option)</p>
Explanation	<p>(1) The storage area in flash ROM on the CPU board has a total capacity of 192 KB. If the memory board is available, the stored area increases as followings. 1MB: 00 to 16 (0 KB to 1024 KB) 2MB: 00 to 32 (0 KB to 2024 KB) 3MB: 00 to 48 (0 KB to 3072 KB) 4MB: 00 to 64 (0 KB to 4096 KB) 6MB: 00 to 96 (0 KB to 6144 KB) 8MB: 00 to 99 (0 KB to 8192 KB)</p> <p>(2) If this command is received, the complete area in flash ROM on the CPU / memory board is cleared.</p> <p>(3) If this command is not sent, the storage area in flash ROM on the CPU / memory board cannot be used.</p> <p>(4) The storage areas are allocated in the following order – the TrueType font storage area, the bit map writable character storage area, and the BASIC file storage area. After these storage areas are allocated, the remaining area is used for the PC save area.</p> <p>(5) If the sum of the TrueType font storage area, the bit map writable character storage area, and the BASIC file storage area, specified by this command, is 192 KB, the TrueType font storage area, the bit map writable character storage area, and the BASIC file storage area are allocated as specified. However, the PC save area is not allocated.</p> <p>(6) If the sum of TrueType font storage area, the bit map writable character storage area, and the BASIC file storage area, specified by this command, exceeds 192 KB, the TrueType font storage area is allocated first, as specified. Then, the remaining area is allocated to the bit map writable character storage area. If there is remaining area after the TrueType font storage area and the bit map writable character storage area are allocated, it is used for the BASIC file storage area. The PC save area is not allocated.</p>

- (7) When "00" (0 KB) is specified for the TrueType font storage area, the bit map writable character storage area, or the BASIC file storage area, the storage area is not allocated.
- (8) When "192" (192 KB) is specified for any of the TrueType font storage area, the bit map writable character storage area, and the BASIC file storage area, all storage areas are used. Therefore, other storage areas cannot be allocated. For example, if "192" is specified for the TrueType Font storage area, all storage areas are used for the TrueType Font storage area. The bit map writable character storage area, the BASIC file storage area, and the PC save area cannot be allocated.

Refer to

- Bit Map Writable Character Command ([ESC] XD)
- Save Start Command ([ESC] XO)
- Memory Card Format Command ([ESC] J1)
- 2-byte Writable Character Code Range Command ([ESC] XE)

Example

The TrueType font storage area and bit map writable character storage area are set to 64 KB and 64 KB, respectively.

(PC save area: $192\text{ KB} - 64\text{KB} - 64\text{ KB} = 64\text{ KB}$)

[ESC] XF; 01, 01 [LF] [NUL]

6.3.18 MEMORY BOARD FORMAT COMMAND

[ESC] J1

Function	Formats (initializes) the flash memory board for storage.
Format	[ESC] J1; a (, b) [LF] [NUL]
Term	<p>a: Formatting (initializing) range for flash memory</p> <ul style="list-style-type: none">A: All areaB: PC save areaC: Bitmap writable character storage areaD: True Type areaE: Basic file area (Reserved for future) <p>b: Drive (Omissible, If omitted, flash ROM on the CPU board is selected.)</p> <ul style="list-style-type: none">0: Flash ROM on the CPU board1: Flash ROM on the memory board (Option)2: Flash ROM on the memory board (Option)
Explanation	<ol style="list-style-type: none">(1) 1, 2, 3, 4, 6, 8 MB flash memory board can be formatted.(2) The flash memory board can be roughly divided into the PC save area and the writable character storage area. They can be formatted (initialized) either separately or at the same time.(3) When using a new flash memory board, the area to be used must be formatted (initialized) before the PC interface command is saved or writable characters are stored.(4) After formatting the flash memory board, the remaining memory is the PC save area and writable character storage area.(5) When the flash memory board is used and the already stored data (PC interface commands, writable characters, logos) is stored again, memory is consumed with every storing unless the Format Command ([ESC] J1) is transmitted.(6) When performing the label issue operation after sending the Memory Board Format Command, the image buffer is automatically cleared.(7) When storing of writable characters, logos, or PC interface commands is not continued, the printer automatically enters the online mode (label issue operation) after about 10 seconds. In this case, the image buffer is automatically cleared.
Refer to	<ul style="list-style-type: none">• Bit Map Writable Character Command ([ESC] XD)• Save Start Command ([ESC] XO)• Save Terminate Command ([ESC] XP)
Example	[ESC] J1; A, 1 [LF] [NUL]

6.3.19 2-BYTE WRITABLE CHARACTER CODE RANGE COMMAND [ESC] XE

Function Sets the code range when a 2-byte writable character code is stored in flash ROM on the CPU board or the flash memory board.

Format [ESC] XE;(Sj, cc,)a₁a₁a₁a₁, b₁b₁b₁b₁, a₂a₂a₂a₂, b₂b₂b₂b₂ ---, a_na_na_na_n, b_nb_nb_nb_n [LF] [NUL]

Term

Sj, cc,: Drive and Writable character set (Omissible, If omitted, flash ROM on the CPU board and writable character set "51" are selected.)

0, 51: Flash ROM on the CPU board
Writable character code 51

1,51 to 55: Flash ROM on the memory board
Writable character code 51 to 55

aaaa: First character code for each range
2020 to FFFF (Indicates the hex. data in ASCII code.)

bbbb: No. of characters for each range
0001 to 4000 (Indicates the hex. data in ASCII code.)

Explanation

- (1) For a 2-byte character code such as Kanji, the character code range may be divided into two or more. The control information area for the unnecessary code can be deleted by designating the character code range, and the capacity of flash memory is not wasted.
- (2) The total number of characters for each range must not exceed 0x4000 (16384 characters).
- (3) Up to 2700 can be designated for the range.
- (4) A character code which is not appropriate for the setting for this command cannot be stored.

Refer to

- Memory Card Format Command ([ESC] J1)
- Bit Map Writable Character Command ([ESC] XD)

Example In the case that Shift JIS 8140H to 83DFH: Character data is present.
 Character data is not present.

	0	1	2	3	4	5	6	7	8	9	A	B	C	D	E	F
8140																
:																
81F0																
:																
8240																
:																
82F0																
:																
8340																
:																
83D0																

[ESC] XE; 8140, 00BD, 8240, 00B7, 8340, 00BD [LF] [NUL]

6.3.20 BIT MAP WRITABLE CHARACTER COMMAND

[ESC] XD

Function	Writes writable characters and logos in the flash memory board, or flash ROM on the CPU board.
Format	For the flash memory board or flash ROM on the CPU board [ESC] XD; (Sj,) aa, b, ccc, ddd, eee, fff, ggg, h, iii ----- iii [LF] [NUL]
Term	Sj: Drive 0: Flash ROM on the CPU board 1: Flash ROM on the memory board (Option) 2: Flash ROM on the memory board (Option) aa: Writable character set • Flash memory board or Flash ROM on the CPU board 01 to 40 51 to 55 (2-byte code character) b(b): Writable character code • Flash memory board or Flash ROM on the CPU board 20H to FFH (Set in hex.) 40H to 7EH, 80H to FCH (When the writable character set is 41 to 44) 2020H to FFFFH (When the writable character set is 51 to 55) ccc: Left offset 000 to 719 (in dots) ddd: Top offset 000 to 719 (in dots) eee: Character width 001 to 720 (in dots) fff: Character height 001 to 720 (in dots)

ggg: Horizontal spacing/proportional spacing
000 to 999 (in dots)

h: Type of writable character data
0: Nibble mode (4 bits/byte)
1: Hex. mode (8 bits/byte)

iii --- iii: Writable character data to be stored

* If each parameter for left offset, top offset, character width, character height, and horizontal spacing/proportional spacing is fixed as "000", the setting is ignored when the writable character set is 41 to 44,

Explanation

(1) Type of writable character

Up to 40 and 49 writable character sets can be stored for the memory board, respectively. However, the maximum number of characters varies depending on the writable character size and number of characters because of the limited memory capacity. For writable character sets 41 to 44, each writable character size is fixed.

(2) Character code

Up to 224 characters can be stored per character set. The maximum number of characters is 40 sets × 224 characters = 8960 characters. It varies depending on the writable character size and number of characters because of the limited memory capacity. For character sets 41 to 44, a character code consisting of 1 byte is stored. However, when the character code is called up, F0H is added to the upper digit of it, and consists of 2 bytes. In this case, up to 188 characters can be stored per character set.

(3) 1, 2, 3, 4, 6, 8 MB memory board can be used for storing a writable character.

(4) The configuration of the writable character file stored in the memory board is as follows.

1st byte	No. of dots for left offset
2nd byte	(from upper to lower)
3rd byte	No. of dots for top offset
4th byte	(from upper to lower)
5th byte	No. of dots for character height
6th byte	(from upper to lower)
7th byte	No. of dots for character width
8th byte	(from upper to lower)
9th byte	No. of dots for horizontal spacing/proportional spacing
10th byte	(from upper to lower)
11th byte	Writable character data (Hex. data)
⋮	(If it is stored in the nibble mode, data is 8 bits/byte.)

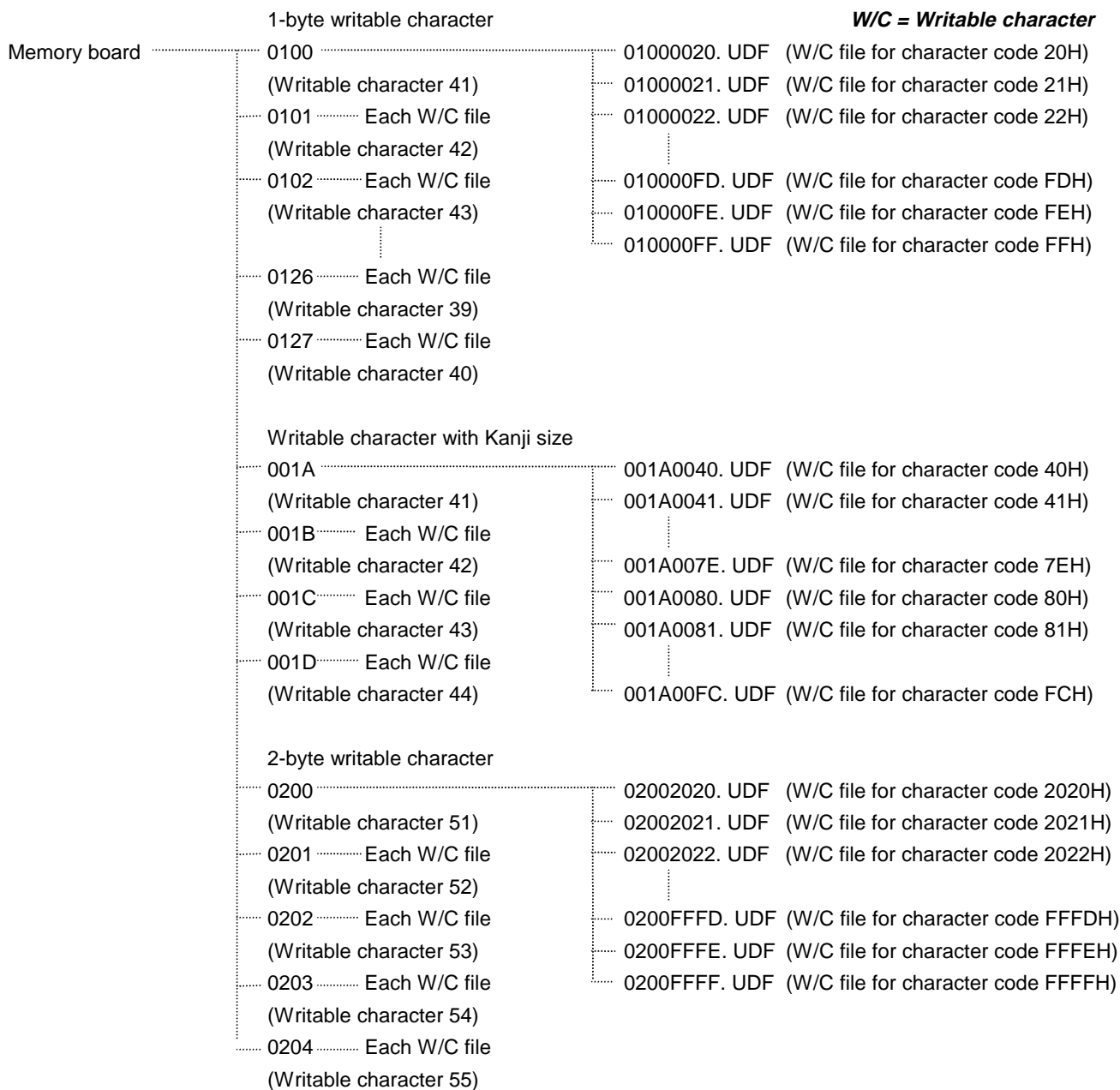

• How to assign the directory name for a writable character set

Directory name for writable character 01	→	"0100"
Directory name for writable character 02	→	"0101"
⋮		
Directory name for writable character 39	→	"0126"
Directory name for writable character 40	→	"0127"
Directory name for writable character 41	→	"001A"
⋮		
Directory name for writable character 44	→	"001D"
Directory name for writable character 51	→	"0200"
⋮		
Directory name for writable character 55	→	"0204"

• How to assign the file name

0100	0022. UDF	(Writable character 40: writable character file for character code 22H)
┌──────────┴──────────┐		
Identifier indicating the writable character file		
┌──────────┴──────────┐		
Character code (2-byte code: Code 22H)		
┌──────────┴──────────┐		
Writable character set (Writable character 40: Same as the directory name)		

(6)

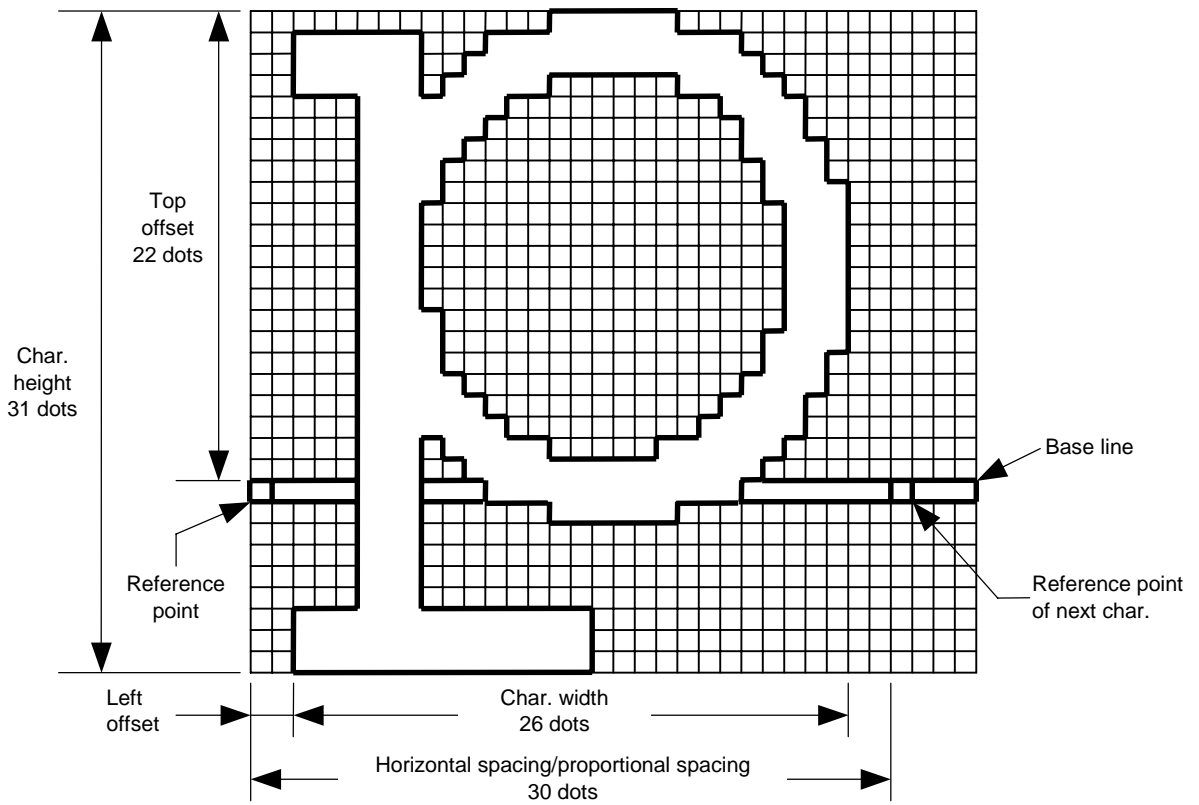

(7) Writable character set: 01 to 40, 51 to 55

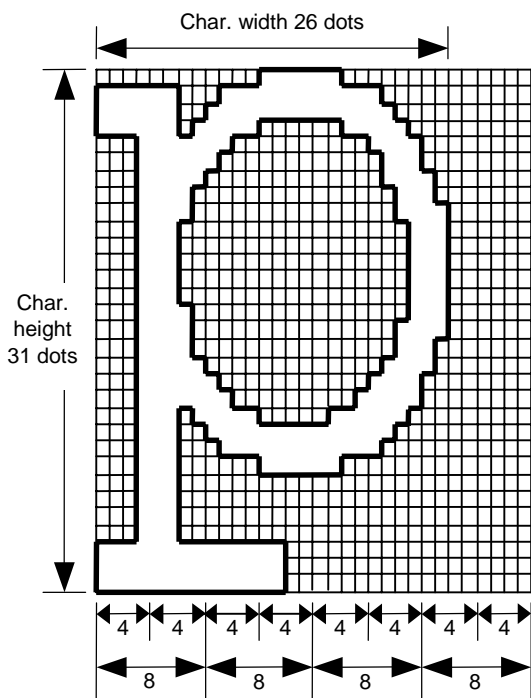

Nibble mode							
1	30H	2	30H	3	30H	4	3FH
5	3CH	6	30H	7	30H	8	30H
9	3FH	10	3CH	11	37H		•
							•
							•
							•
							•
							•
						240	30H
241	3FH	242	3FH	243	3FH	244	3CH
245	30H	246	30H	247	30H	248	30H

Hex. mode			
1	00H	2	0FH
3	C0H	4	00H
5	FCH	6	7FH
			•
			•
			•
			•
			•
			•
			•
		120	00H
241	FFH	242	FCH
243	00H	244	00H

[Nibble mode]

- (1) The writable character data to be stored is separated into four dot units and sent in the following order (**1** → **248**). (High order digit: "3")
- (2) The data of writable characters to be stored is 30H to 3FH.
- (3) The minimum unit in the X direction is 8 dots. Dots with no data are transmitted as data 0.
- (4) The data count of writable characters to be stored must be as follows:
Data count of writable characters to be stored =
 $\{(No. \text{ of char. width dots} + 7)/8\} \times No. \text{ of char. height dots} \times 2$
* The value in the brackets is rounded down to the nearest whole number.

[Hex. mode]

- (1) The writable character data to be stored is separated into eight dot units and sent in the following order (**1** → **124**).
- (2) The data of writable characters to be stored is 00H to FFH.
- (3) The minimum unit in the X direction is 8 dots. Dots with no data are transmitted as data 0.
- (4) The data count of writable characters to be stored must be as follows:
Data count of writable characters to be stored =
 $\{(No. \text{ of char. width dots} + 7)/8\} \times No. \text{ of char. height dots}$
* The value in the brackets is rounded down to the nearest whole number.

Notes

- (1) With the same writable character set designated, character width and character height can be designated for each writable character code. In other words, character size can be changed for each character, thus saving memory.
- (2) Proportional spacing and descending characters are possible depending on the parameters of horizontal spacing/proportional spacing, left offset, and top offset.
- (3) When top offset is 000, the reference coordinates are at the above left when drawing because the base line is at the top. (Coordinate setting is facilitated for logos.)

(8) Writable character set: 41 (16×16 dots)

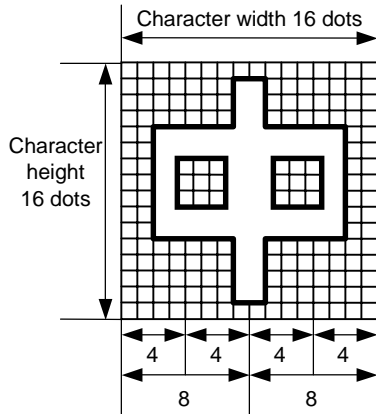

Nibble mode			
1	30H	2	30H
3	30H	4	30H
5	30H	6	31H
		7	38H
		.	
		.	
		.	
		58	31H
		59	38H
		60	30H
61	30H	62	30H
63	30H	64	30H

Hex. mode			
1	00H	2	00H
3	01H	4	80H
5	01H	6	80H
		7	01H
		.	
		.	
		.	
		26	80H
		27	01H
		28	80H
29	01H	30	80H
31	00H	32	00H

[Nibble mode]

- (1) The writable character data to be stored is separated into four dot units and sent in the following order (**1** → **64**). (High order digit: "3")
- (2) The data of writable characters to be stored is 30H to 3FH.
- (3) The data count of writable characters to be stored should be 64 bytes.

[Hex. mode]

- (1) The writable character data to be stored is separated into eight dot units and sent in the following order (**1** → **32**).
- (2) The data of writable characters to be stored is 00H to FFH.
- (3) The data count of writable characters to be stored should be 32 bytes.

* When writable character 41 is designated, the width and height of the character are both 16 dots.

(9) Writable character set: 42 (24x24 dots)

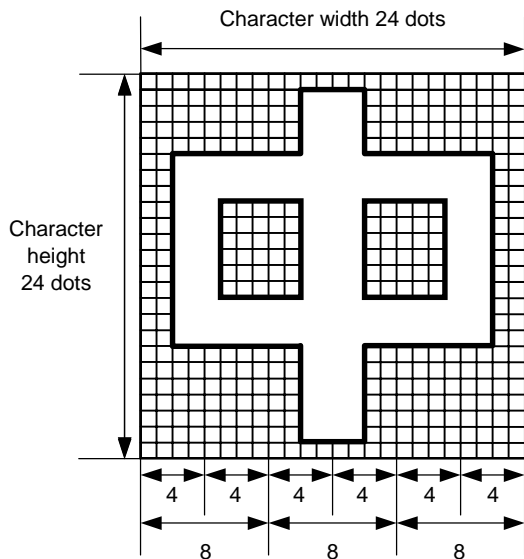

Nibble mode													
1	30H	2	30H	3	30H	4	30H	5	30H	6	30H		
7	30H	8	30H	9	33H								
•													
•													
•													
•													
•													
										137	30H	138	30H
139	30H	140	30H	141	30H	142	30H	143	30H	144	30H		

Hex. mode					
1	00H	2	00H	3	00H
4	00H	5	3CH	6	00H
•					
•					
•					
•					
67	00H	68	3CH	69	00H
70	00H	71	00H	72	00H

[Nibble mode]

- (1) The writable character data to be stored is separated into four dot units and sent in the following order (**1** → **144**). (High order digit: "3")
- (2) The data of writable characters to be stored is 30H to 3FH.
- (3) The data count of writable characters to be stored should be 144 bytes.

[Hex. mode]

- (1) The writable character data to be stored is separated into eight dot units and sent in the following order (**1** → **72**).
- (2) The data of writable characters to be stored is 00H to FFH.
- (3) The data count of writable characters to be stored should be 72 bytes.

* When writable character 42 is designated, the width and height of the character are both 24 dots.

(10) Writable character set: 43 (32×32 dots)

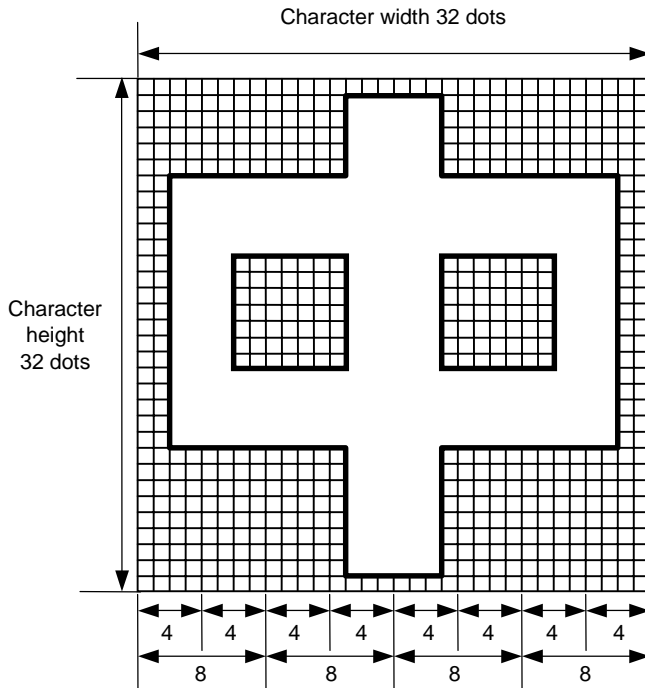

Nibble mode													
1	30H	2	30H	3	30H	4	30H	5	30H	6	30H	7	30H
8	30H	9	30H	10	30H	11	30H	12	37H				
•													
•													
•													
•													
•													
										248	30H	249	30H
250	30H	251	30H	252	30H	253	30H	254	30H	255	30H	256	30H

Hex. mode									
1	00H	2	00H	3	C0H	4	00H		
5	00H	6	07H	7	C0H				
•									
•									
•									
•									
						123	C0H	124	00H
125	00H	126	00H	127	00H	128	00H		

[Nibble mode]

- (1) The writable character data to be stored is separated into four dot units and sent in the following order (**1** → **256**). (High order digit: "3")
- (2) The data of writable characters to be stored is 30H to 3FH.
- (3) The data count of writable characters to be stored should be 256 bytes.

[Hex. mode]

- (1) The writable character data to be stored is separated into eight dot units and sent in the following order (**1** → **128**).
- (2) The data of writable characters to be stored is 00H to FFH.
- (3) The data count of writable characters to be stored should be 128 bytes.

* When writable character 43 is designated, the width and height of the character are both 32 dots.

(11) Writable character set: 44 (48×48 dots)

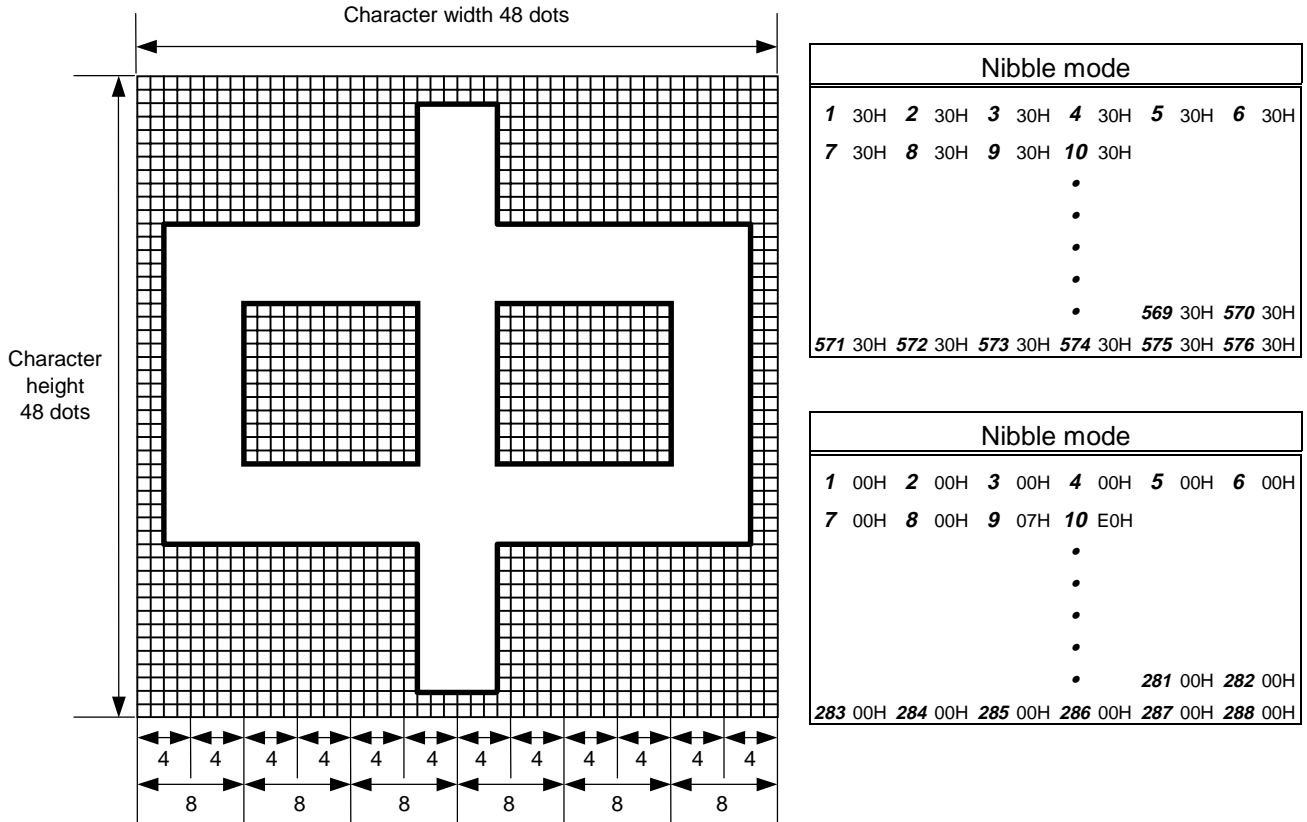

[Nibble mode]

- (1) The writable character data to be stored is separated into four dot units and sent in the following order (**1** → **576**). (High order digit: "3")
- (2) The data of writable characters to be stored is 30H to 3FH.
- (3) The data count of writable characters to be stored should be 576 bytes.

[Hex. mode]

- (1) The writable character data to be stored is separated into eight dot units and sent in the following order (**1** → **288**).
- (2) The data of writable characters to be stored is 00H to FFH.
- (3) The data count of writable characters to be stored should be 288 bytes.

* When writable character 44 is designated, the width and height of the character are both 48 dots.

Notes

- (1) No matter what character set or character code is selected, no memory will be wasted.
- (2) When a new writable character is stored, the Flash Memory board Format Command ([ESC] J1) must be transmitted.
- (3) A character code already stored can be stored in the flash memory board again if the Writable Character Command ([ESC] XD) is transmitted, but memory will be consumed with every storage. Memory can be efficiently used by sending the Format Command ([ESC] J1) before storing.
- (4) If a flash memory card is used, and a label issue operation is performed after sending the Bit Map Writable Character Command ([ESC] XD), the image buffer is cleared automatically.
- (5) When the storing operation stops after storing the writable character and logos, the printer automatically enters the online mode (label issue operation) after about 10 seconds. In this case, when the flash memory board is used, the image buffer will be cleared automatically.

Refer to

Flash Memory Board Format Command ([ESC] J1)

Examples

Writable character set: 03
 Writable character code 70H

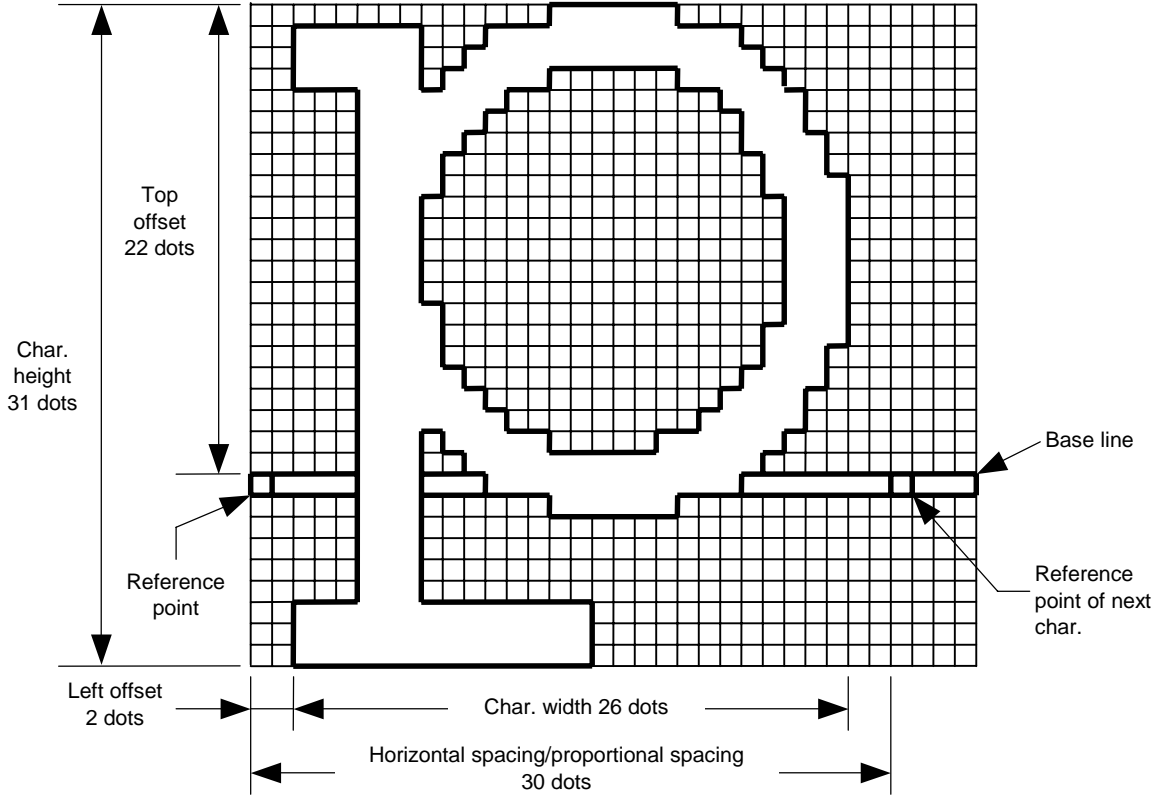

```
[ESC] J1; C [LF] [NUL]
[ESC] XD; 03, p, 002, 022, 026, 031, 030, 0, 000?<000?<7??800?<???<00?=?03>001?
<00?001?8007001?0007801>0003801>0003<01<0001<01<0001<01<0001<01<0001<01<0001<01>0
001<01>0003<01>0003801?0007801?800?001?<01?001=?07>001<???<001<7??8001<0?<
0001<0000001<0000001<0000001<000000???<0000???<0000???<0000 [LF] [NUL]
```

- * 30H = "0"
- 31H = "1"
- 32H = "2"
- 33H = "3"
- 34H = "4"
- 35H = "5"
- 36H = "6"
- 37H = "7"
- 38H = "8"
- 39H = "9"
- 3AH = "."
- 3BH = ","
- 3CH = "<"
- 3DH = "="
- 3EH = ">"
- 3FH = "?"

6.3.21 GRAPHIC COMMAND

[ESC] SG

Function	Draws graphic data.
Format	[ESC] SG; aaaa, bbbb, cccc, dddd, e, ggg --- ggg [LF] [NUL] or [ESC] SG0; aaaa, bbbb, cccc, dddd, e, ffff, ggg --- ggg [LF] [NUL]
Term	<p>aaaa: Print origin of X-coordinate for drawing graphic data Fixed as 4 digits (in 0.1 mm units)</p> <p>bbbb: Print origin of Y-coordinate for drawing graphic data 4 or 5 digits (in 0.1 mm units)</p> <p>cccc: No. of graphic width dots Fixed as 4 digits (in dots) However, when the graphic data "2: BMP file" or "6: PCX file" is selected, this designation is ignored. (The information of the graphic width is contained in the graphic data.)</p> <p>dddd: No. of graphic height dots 4 or 5 digits (in dots) However, when the graphic data "2: BMP file" or "6: PCX file" is selected, this designation is ignored. (The information of the graphic width is contained in the graphic data.) When "3: TOPIX compression mode" is selected for the type of graphic data: Resolution of graphic data: *only two types { 0150: 150 DPI (The data is drawn in double resolution.) { 0300: 300 DPI (The data is drawn in single resolution.)</p> <p>e: Type of graphic data [ESC] SG; -- command: 0: Nibble mode (4 dots/byte) Overwrite drawing 1: Hex. mode (8 dots/byte) Overwrite drawing 2: BMP file mode (monochrome bmp) Overwrite drawing 3: TOPIX compression mode Overwrite drawing 4: Nibble mode (4 dots/byte) OR drawing 5: Hex. mode (8 dots/byte) OR drawing 6: PCX file mode (monochrome pcx) Overwrite drawing [ESC] SG0; -- command: A: Printer driver compression mode Overwrite drawing</p> <p>ffff: Data count (Effective only for [ESC] SG0; -- command) Fixed as 4 digits Represents the total number of bytes for the compressed graphic data by 32 bits in Hex. Range: 0 to 4,294,967,295 bytes (00H, 00H, 00H, 00H to FFH, FFH, FFH, FFH)</p> <p>ggg --- ggg: Graphic data</p>

Explanation

- (1) When the graphic data "0", "1", "2", "3", "6", or "A" is selected, the graphic data is drawn by overwriting the image buffer.
- (2) When the graphic data "4" or "5" is selected, the graphic data is drawn by carrying out OR between the graphic data and the data in the image buffer.

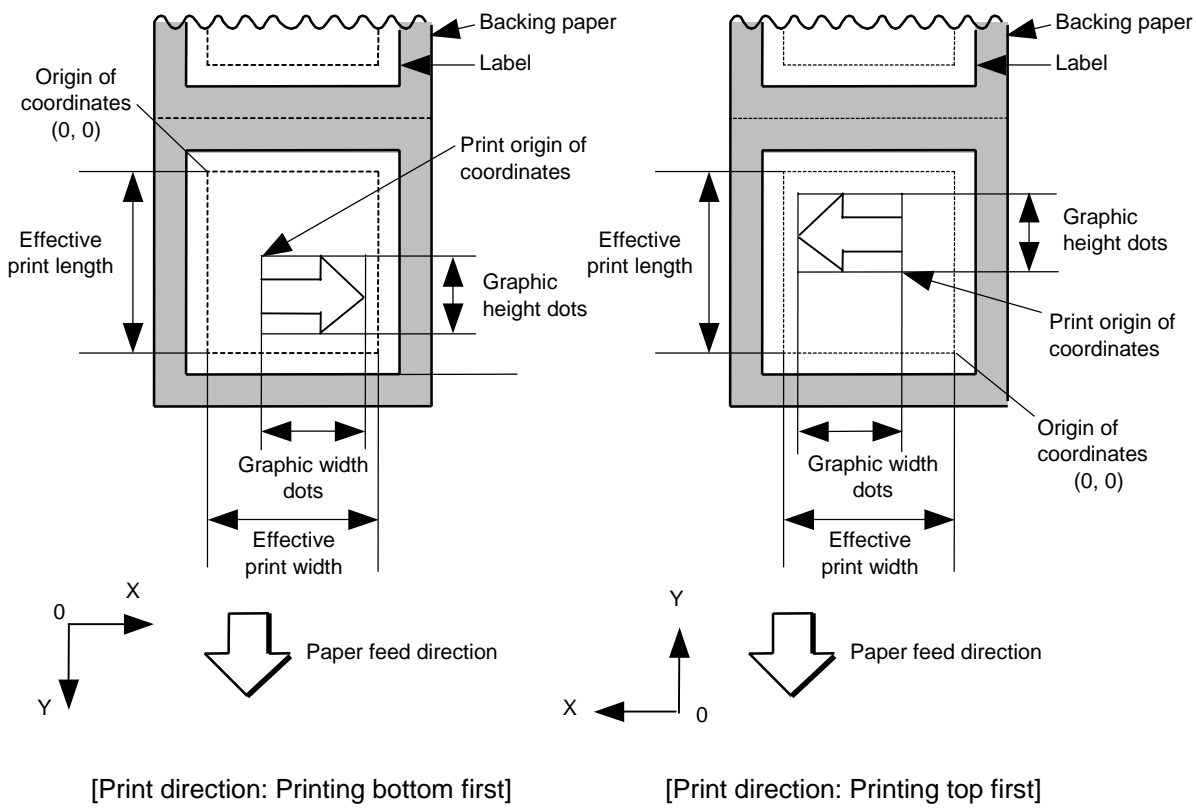

[When TOPIX compression mode is selected]

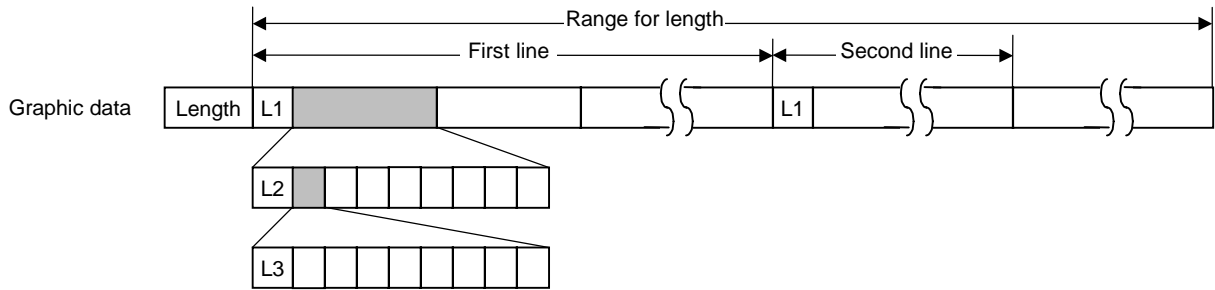

(1) Length: Total number of bytes of the graphic data (0001H ~)

Ex. Length = 20 bytes:

00	14
----	----

(2) L1 parameter: Shows in which large block (512 dots/block) the changed data is contained.

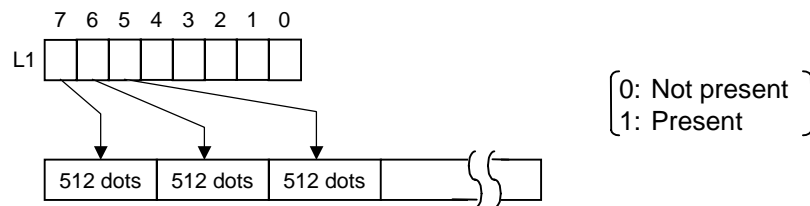

(3) L2 parameter: Shows in which medium block (64 dots/block) the changed data is contained (of the L1 large block).

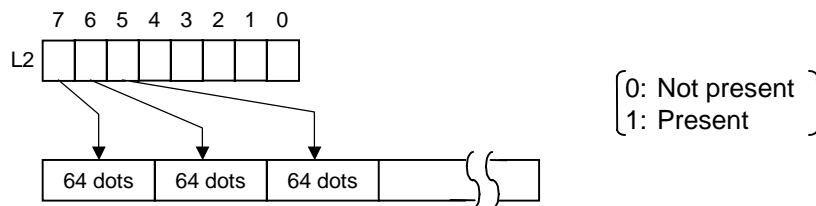

(4) L3 parameter: Shows in which small block (8 dots/block) the changed data is contained (of the L2 medium block).

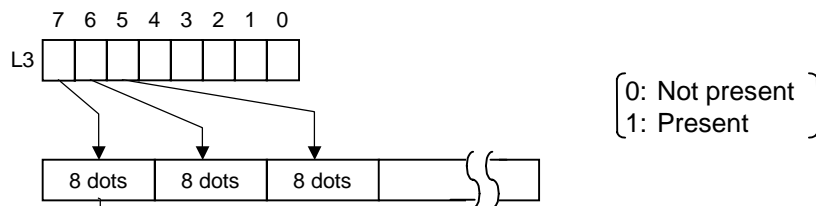

Exclusive-OR is carried out between the current image data and the image data one line previous. Only the changed bit is set to ON (1). The alignment of dots is MSB (left dots) and LSB (right dots).

* The graphic width for only the smaller value of either the designated value or the max. buffer size (512 KB) is drawn. The minimum unit of the data drawing is 8 dots (1 byte). If the graphic width is set to 3 dots, it will be reset to 8 dots (1 byte).

[When the printer driver compression mode is selected]

(1) For the [ESC] SGO; -- command, only "A: Printer driver compression mode" can be selected for the type of graphic data. The parameter for the data count is attached after the parameter for the type of graphic data. When the total number of data cannot be provided by the printer driver, "00H, 00H, 00H, 00H" should be specified for the number of graphic data. However, in this case, the printer diver cannot support printing through a serial interface (RS-232C).

(2) How to compress data

Compression is performed for every data of one line specified for the number of graphic width dots.

The data is made up in units of 8 dots. A repeated value is encoded in 2 bytes. The first byte is a numeric value n indicating that a value is repeated (-n + 1) times.

The range is between -127 and -1. The second byte is the repeated value.

If a value is not repeated the first byte is the numeric value m. The length of the values is indicated in (m+1). The range of "m" is between 0 and 126. The length of the repetition of the value and "m" should not exceed 127 and 126, respectively.

If it exceeds the range, it should be divided into blocks of repetition.

When the same contents as the data for 1 line appear repeatedly in the next line and after, the number of lines in which the same contents appear is encoded in 2 bytes. The first byte is fixed as 127. The second byte indicates "N" times that the same contents are repeated. Its range is between 1 and 255. "N" should not exceed 255. If it exceeds the range, the data for the excess number of times should be compressed as the new data of 1 line, and the remaining number of repetitions should be encoded.

[Example]

Data before being compressed (Width: 120 dots, Height: 300 lines)

Line No.	Graphic data
1	AAh AAh AAh AAh AAh AAh AAh AAh BBh CCh DDh EEh FFh FFh FFh FFh
2	AAh AAh AAh AAh AAh AAh AAh AAh BBh CCh DDh EEh FFh FFh FFh FFh
	⋮
299	AAh AAh AAh AAh AAh AAh AAh AAh BBh CCh DDh EEh FFh FFh FFh FFh
300	AAh AAh AAh AAh AAh AAh AAh AAh BBh CCh DDh EEh FFh FFh FFh FFh

Data after being compressed

Line No.	Graphic data
1	<u>FAh AAh</u> <u>03h BBh CCh DDh EEh</u> <u>FEh FFh</u>
2 to 256	7FH FFH
257	<u>FAh AAh</u> <u>03h BBh CCh DDh EEh</u> <u>FDh FFh</u>
258 to 300	7FH 2BH

FAh = -6
 $-(-6) + 1 = 7$
 AAh is repeated 7 times.

03h = 3
 $3 + 1 = 4$
 4-byte data (BBh CCh DDh EEh) without repetition

FDh = -3
 $-(-3) + 1 = 4$
 FFh is repeated 4 times.

Notes

- (1) The print origin of coordinates must be set so that the result of drawing the graphic data will be within the effective print area set by the Label Size Set Command ([ESC] D).
- (2) The number of graphic width dots and the number of graphic height dots must also be set so that the result of drawing the graphic data will be within the effective print area set by the Label Size Set Command ([ESC] D) in the same manner as the above.
- (3) Both width and height are 8 dots/mm.
- (4) The actual result of drawing may deviate within ± 0.33 mm in the X direction with respect to the designated print origin of the X-coordinate.

To draw the received graphic data at high speed, the data is directly developed in the image buffer without applying correction to each bit with respect to the designated X-coordinate. Consequently, an error of up to 4 bits occurs.

[Effective print area] [mm]

Item		Model		B-SV4D		
		Method	Batch	Strip	Cutter	
Effective print width		Min.	13.0			
		Max.	108 ± 0.2			
Effective print length	Label	Min.	8.0	23.4	13.0	
		Max.	607.6			
	Tag	Min.	8.0	-	13.0	
		Max.	607.6	-	607.6	

Examples

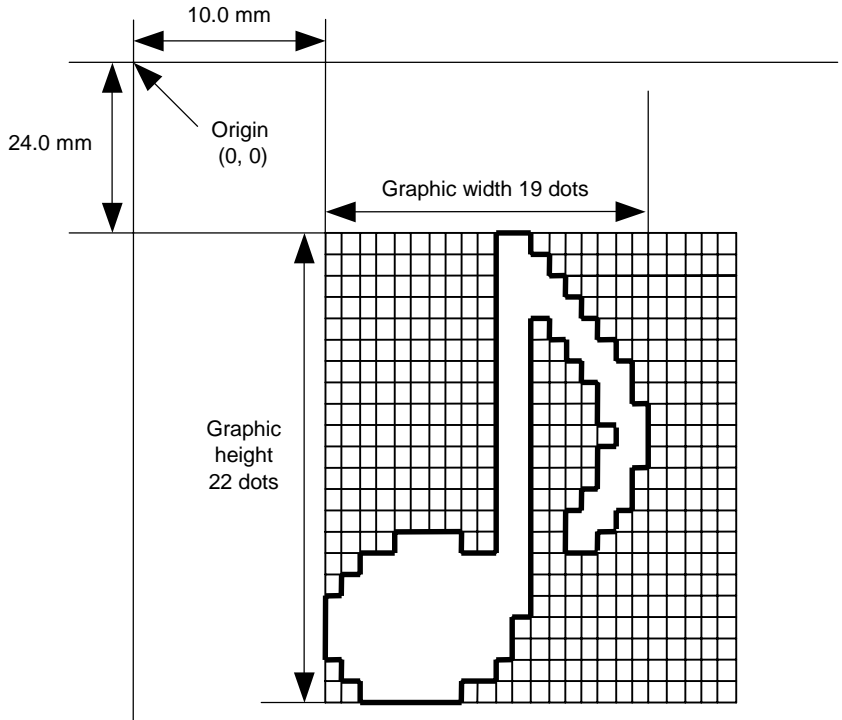

```
[ESC] C [LF] [NUL]
[ESC] SG; 0100, 0240, 0019, 0022, 0, 003000003800003<00003>000037000033800031
<00030<00030>00030600030>00030<00031<00033800?33003??0007??000??000??
>000??>0007? <0003?0000 [LF] [NUL]
[ESC] XS; I, 0001, 0002C3000 [LF] [NUL]
```

- | | |
|-------------|------------|
| * 30H = "0" | 38H = "8" |
| 31H = "1" | 39H = "9" |
| 32H = "2" | 3AH = ":", |
| 33H = "3" | 3BH = ",", |
| 34H = "4" | 3CH = "<," |
| 35H = "5" | 3DH = "=", |
| 36H = "6" | 3EH = ">," |
| 37H = "7" | 3FH = "?," |

[TOPIX compression mode]

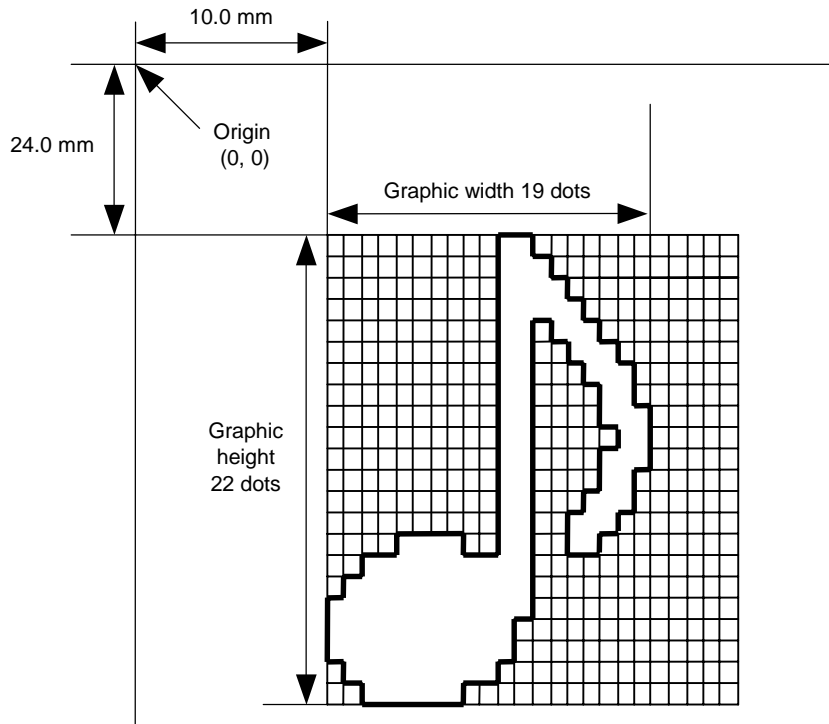

[ESC] SG; 0100, 0240, 0019, 0300, 3, 00 5C 80 80 40 30
 Length L1 L2 L3 Data (1st line)

80 80 40 08 80 80 40 04 80 80 40 02 80 80 40 09
 (2nd line) (3rd line) (4th line) (5th line)

80 80 60 04 80 80 80 60 02 40 80 80 40 01 80 80 20 20
 (6th line) (7th line) (8th line) (9th line)

80 80 20 80 80 80 20 80 80 80 20 20 80 80 40 01
 (10th line) (11th line) (12th line) (13th line)

80 80 60 02 40 80 80 A0 0F 80 80 80 C0 30 C3 80 80 80 40
 (14th line) (15th line) (16th line) (17th line)

80 80 80 80 80 80 40 10 00 80 80 C0 80 20 80 80 C0 40 C0 [LF] [NUL]
 (18th line) (19th line)(20th line) (21st line) (22nd line)

6.3.22 SAVE START COMMAND

[ESC] XO

Function	Declares the start of saving PC interface commands. (Places the printer in the mode where PC interface commands are written in the flash ROM on the memory board, or flash ROM on the CPU board.)
Format	[ESC] XO; aa, (Sb,) c [LF] [NUL]
Term	aa: Identification number to be used for saving in the flash memory board or calling 01 to 99 ddddddd: Ignore Sb: Drive in which the PC interface command is stored b: Drive 0: Flash ROM on the CPU board 1: Flash ROM on the memory board (Option) 2: Flash ROM on the memory board (Option) c: Status response at save time 0: No status response made 1: Status response made
Explanation	(1) When the PC interface command is stored in the memory board, directory "PCSAVE" is created, and then the directory "Specified file name. PCS" is created under the "PCSAVE" directory level.
Notes	(1) After sending the Save Start Command ([ESC] XO), any command other than the following will be saved into the flash memory board. <ul style="list-style-type: none">• Save Start Command ([ESC] XO)• Save Terminate Command ([ESC] XP)• Saved Data Call Command ([ESC] XQ)• Bit Map Writable Character Command ([ESC] XD)• Reset Command ([ESC] WR)• Status Request Command ([ESC] WS)• Memory Board Format Command ([ESC] J1) (2) No error check is made for the commands at save time.
Refer to	<ul style="list-style-type: none">• Save Terminate Command ([ESC] XP)• Memory Board Format Command ([ESC] J1)

Examples

[ESC] J1; B [LF] [NUL]

[ESC] XO; 01, 0 [LF] [NUL]

[ESC] D0508, 0760, 0468 [LF] [NUL]

[ESC] T20C30 [LF] [NUL]

[ESC] C [LF] [NUL]

[ESC] PC001; 0200, 0125, 1, 1, A, 00, B [LF] [NUL]

[ESC] PC002; 0650, 0550, 2, 2, G, 33, B, +0000000001 [LF] [NUL]

[ESC] XP [LF] [NUL]

6.3.23 SAVE TERMINATE COMMAND

[ESC] XP

Function	Declares the termination of saving PC interface commands.
Format	[ESC] XP [LF] [NUL]
Note	If the storing operation is not continued after storing the PC interface command, the printer enters the online mode (label issue operation) after about 10 seconds. In this case, the image buffer will be cleared automatically.
Refer to	Save Start Command ([ESC] XO)

6.3.24 SAVED DATA CALL COMMAND

[ESC] XQ

Function	Calls PC interface commands saved in the flash ROM on the memory board, or flash ROM on the CPU board.
Format	[ESC] XQ; aa, (Sb,) c, d [LF] [NUL]
Term	aa: Identification number of the file to be called from the flash memory board 01 to 99 ddddddd: Ignore Sb: Drive from which the command is called b: Drive 0: Flash ROM on the CPU board 1: Flash ROM on the memory board (Option) 2: Flash ROM on the memory board (Option) c: Status response when the data is called up 0: No status response made 1: Status response made d: Auto call at power on time L: Auto call (Always call 01 file with Auto call. Refer to Page 8 for cancel.) M: No auto call
Notes	(1) If the relevant save identifier is not found, an error will result. (2) However, if no save number subject to auto call is found with the option for auto call at power on time selected, the option for no auto call will be selected causing no error. (3) If a command error is found in the PC interface command in auto call at power on time by the Saved Data Call Command, a command error will result. After an error has occurred, the power must be turned off. The option for no auto call is selected when the power is turned on again. (4) The printer enters the online mode (label issue operation) when the Save Data Call Command is sent after the Save Terminate command.
Refer to	<ul style="list-style-type: none">• Save Start Command ([ESC] XO)• Save Terminate Command ([ESC] XP)
Examples	[ESC] XQ; 01, 0, L [LF] [NUL] [ESC] RC001; Sample [LF] [NUL] [ESC] RC002; 100 [LF] [NUL] [ESC] XS; I, 0002, 0002C3000 [LF] [NUL]

6.3.25 RESET COMMAND

[ESC] WR

Function	Returns the printer to its initial state.
Format	[ESC] WR [LF] [NUL]
Explanation	The printer is returned to the same state as when the power was turned on. When the printer receives this command during printing, it returns to its initial state after issuing the label which is being printed. The next command must not be sent while the printer is performing initial processing after this command is transmitted.
Notes	<ol style="list-style-type: none">(1) The Reset Command is effective in serial interface (RS-232C), parallel port or USB port.(2) When the printer receives a command in system mode, only the Reset Command can be processed and any other command cannot be processed.(3) If a command error or communication error occurs when receiving the Reset Command, the error message is displayed in the online mode. However, it is not displayed in system mode.(4) After the code of the Writable Character Command ([ESC] XD) or Graphic Command ([ESC] SG) is received, the Reset Command is not processed until the printer receives the data specified for the type of data.
Example	[ESC] WR [LF] [NUL]

6.3.26 STATUS REQUEST COMMAND

[ESC] WS

Function	Sends the printer status to the host computer.
Format	[ESC] WS [LF] [NUL]
Explanation	This command makes the printer send its status regardless of the setting of “status response/no status response.” The status to be transmitted is the current printer status, and indicates the latest status only. The remaining count indicates the remaining count of the batch currently being printed. No remaining count of the batch waiting to be printed is transmitted.
Notes	<ol style="list-style-type: none">(1) This command is available only for the RS-232C and USB interfaces.(2) The status is returned only to the interface which sent this command.(3) After the code of the Writable Character Command ([ESC] XD) or Graphic Command ([ESC] SG) is received, the Status Request Command is not processed until the printer receives the data specified for the type of data.(4) A max. delay of 20 msec may occur until the printer sends the status after receiving the Status Request Command.(5) The interval from when the Status Request Command is sent to when the next Status Request Command is sent should be 20 msec or more. If the interval is less than 20 msec, the printer may fail to receive the Status Request Command.
Example	[ESC] WS [LF] [NUL]

6.3.27 RECEIVE BUFFER FREE SPACE STATUS REQUEST COMMAND

[ESC] WB

Function	Sends information on the printer status and the free space of the receive buffer to the host computer.
Format	[ESC] WB [LF] [NUL]
Explanation	This command makes the printer send information on its status and free space of the receive buffer regardless of the setting of "status response/no status response." The status to be transmitted is the current printer status, and indicates the latest status only. The remaining count indicates the remaining count of the batch currently being printed. No remaining count of the batch waiting to be printed is transmitted. Free space of the receive buffer for the interface which sent this command, is returned to the host.

Status Format (23 bytes)

SOH	01H	Indicates the top of the status block.
STX	02H	
Status	3XH	Detailed status
	3XH	
Status type	33H	Indicates the status requested by the WB command.
Remaining issue count	3XH	Remaining number of labels to be issued.
	3XH	
	3XH	
	3XH	
Length	3XH	Total number of bytes of the status block.
	3XH	"30H30H"(0) ~ "39H39H"(99) Note: In case of this status format(23 bytes), This is "32H33H".
Free space of receive buffer	3XH	Free space of receive buffer "30H30H30H30H30H"(0 Kbyte) ~ "39H39H39H39H39H" (99999 Kbytes) Note: The maximum value must be the receive buffer capacity.
	3XH	
	3XH	
	3XH	
	3XH	
Receive buffer capacity	3XH	Receive buffer capacity "30H30H30H30H30H" (0 Kbyte) ~ "39H39H39H39H39H" (99999 Kbytes) Note: The maximum value differs depending on the models.
	3XH	
	3XH	
	3XH	
	3XH	
CR	0DH	Indicates the end of the status block.
LF	0AH	

Notes

- (1) This command is available only for the RS-232C and USB interfaces.
- (2) The printer returns the status only for the interface which sent this command to the host.
- (3) After the code of the Writable Character Command ([ESC] XD) or Graphic Command ([ESC] SG) is received, the Status Request Command is not processed until the printer receives the data specified for the type of data.
- (4) A max. delay of 20 msec may occur until the printer sends the status after receiving the Status Request Command.
- (5) The interval from when the Status Request Command is sent to when the next Status Request Command is sent should be 20 msec or more. If the interval is less than 20 msec, the printer may fail to receive the Status Request Command.

Example

[ESC] WB [LF] [NUL]

6.3.28 VERSION INFORMATION ACQUIRE COMMAND

[ESC] WV

Function

Sends information such as the program version of the printer.

Format

[ESC] WV [LF] [NUL]

Explanation

(1) The format of the program version data (total 27 bytes of data) to be returned to the host is as follows.

SOH		01H	
STX		02H	
Creation date	"0"	30H	Creation date of program: 9 bytes of data indicated in order of Day- Month-Year
	"4"	34H	
	"A"	41H	
	"P"	50H	
	"R"	52H	
	"2"	32H	
	"0"	30H	
	"0"	30H	
	"3"	33H	
Model	"B"	42H	Model: 7 bytes of ASCII code indicating model
	"_"	2DH	
	"S"	34H	
	"V"	38H	
	"4"	30H	
	"D"	44H	
	SP	20H	
Version	"V"	56H	Program version: 5 bytes of data: Vx.xx └── Revision └── Version
	"1"	31H	
	"."	2EH	
	"0"	30H	
	"A"	41H	
ETX		03H	
EOT		04H	
CR		0DH	
LF		0AH	

(2) This command is one of the types of commands that is processed as it is received. Processing takes place starting from the ones received first. Until the process of the command previously sent is completed, the next command is not processed. Therefore, if the printer is not in the idle state when this command is sent, the program version data may not be returned immediately.

Notes

(1) This command is effective only for the serial interface (RS-232C). This command is not supported for a parallel interface (Centronics), since transmission cannot be performed in the parallel interface.

6.3.29 MEMORY BOARD INFORMATION ACQUIRE COMMAND [ESC] WI

Function Sends information regarding the use of the memory board to the host.

Format [ESC] WI; a, b [LF] [NUL]

Term

a: Drive
 1: Slot 1 memory board (Option)
 2: Slot 1 memory board (Option)

b: Information to be acquired
 A: Free space
 B: Bitmap
 C: Stored PC command save file
 D: TrueType
 E: Basic file (Reserved for future)

Explanation (1) The format of information to be returned to the host is as follows:

A: Free space

SOH	STX	"A"	Slot	Free space (Kbyte)						ETX	EOT	CR	LF
01H	02H	41H	xxH	3xH	3xH	3xH	3xH	3xH	3xH	03H	04H	0DH	0AH

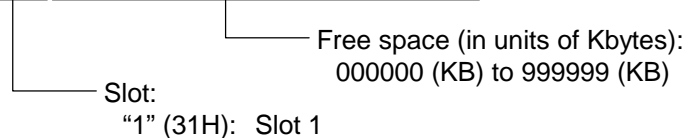

When the memory board is not inserted into a specified slot, "00H, 00H, 00H, 00H, 00H, 00H" is returned for the free spaces.

B: Writable character list

SOH	STX	"B"	Slot	Storage information for writable character (55 bytes)						ETX	EOT	CR	LF
01H	02H	42H	xxH	"0"/"1"	"0"/"1"	"0"/"1"	"0"/"1"	03H	04H	0DH	0AH	

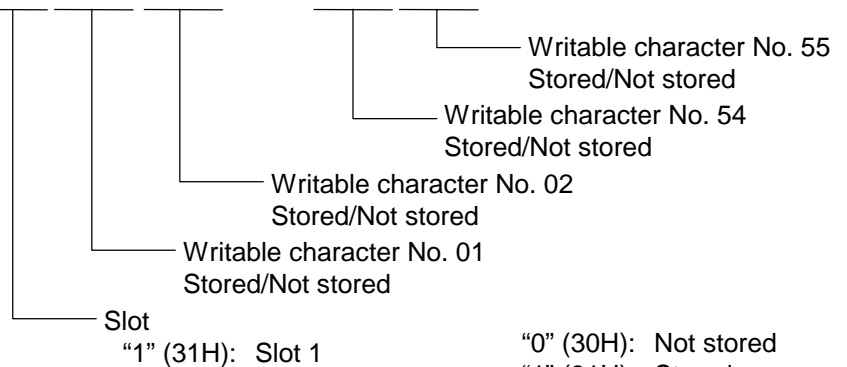

If only one writable character is stored, information of the writable character No. is set to "1" (Stored). The storage information of a specified character code can be acquired by using the memory board Stored Writable Character Information Acquire Command ([ESC] WG).

The storage information for the writable character has a total of 55 bytes. The writable character No. is assigned from 01 to 44, and from 51 to 55. Therefore, bytes to which Nos. 45 to 50 are assigned are sure to be set to "0" (30H). When the memory board is not inserted in the specified slot, "00H" for the storage information for the writable character is returned.

C: Stored PC command save file

SOH	STX	"C"	Slot	Stored PC command save file name	ETX	EOT	CR	LF
01H	02H	43H	xxH	File name 1 00H File name 2 00H ... File name n 00H	03H	04H	0DH	0AH

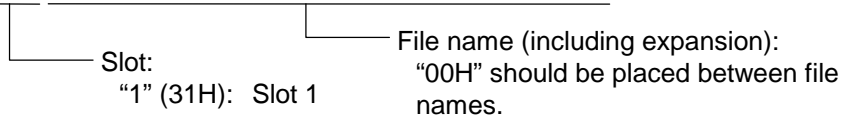

In the following cases, 1 byte of "00H" is returned as the stored PC command save file name.

- ① There is no file.
- ② The memory board is not inserted in the specified slot.

D: Stored True Type Font file

SOH	STX	"D"	Slot	Stored PC command save file name	ETX	EOT	CR	LF
01H	02H	43H	xxH	File name 1 00H File name 2 00H ... File name n 00H	03H	04H	0DH	0AH

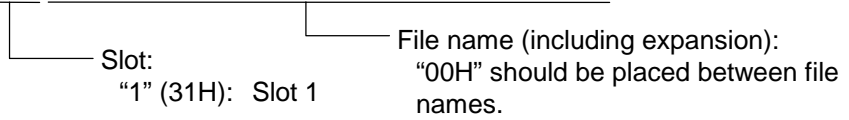

In the following cases, 1 byte of "00H" is returned as the stored True Type Font file name.

- ① There is no file.
- ② The memory board is not inserted in the specified slot.

- (2) This command is one of the types of commands that is processed as it is received. Processing takes place starting from the ones received first. Until the process of the command previously sent is completed, this command is not processed. Therefore, if the printer is not in the idle state when this command is sent, the program version data may not be returned immediately.

Note

- (1) This command is effective only for the serial interface (RS-232C). This command is not supported for a parallel interface (Centronics), since transmission cannot be performed in the parallel interface.

6.3.30 PRINTER INFORMATION STORE COMMAND

[ESC] IG

Function	Sets the printer information.
Format	[ESC] IG; aaa --- aaabbb --- bbb [LF] [NUL]
Term	aaa --- aaa: Model name (Fixed as 20 digits) 20H to 7FH of ASCII codes bbb --- bbb: Serial No. (Fixed as 11digits) 20H to 7FH of ASCII codes
Explanation	(1) The model name and serial No. of the printer can be optionally stored. The character codes which can be set in each item are 20H to 7FH. If any code other than these is used, it is replaced with the space code. (2) The printer information has already been set when shipped. (3) The stored printer information is backed up in memory and is kept even if the power is turned off. (4) This stored information should be printed on test print.
Examples	The following information is stored in the printer. Model name: B-SV4D-GS10-QM Serial No.: 2303A000001 [ESC] IG; [42H] [2DH] [53H] [56H] [34H] [44H] [2DH] [47H] [53H] [31H] [30H] [2DH] [51H] [4DH] [20H] [20H] [20H] [20H] [20H] [32H] [33H] [30H] [33H] [41H] [30H] [30H] [30H] [30H] [30H] [31H] [LF] [NUL]
Refer to	Printer Information Request Command ([ESC] IR)

6.3.31 PRINTER INFORMATION REQUEST COMMAND

[ESC] IR

Function

Retrieves the printer information.

Format

[ESC] IR [LF] [NUL]

Explanation

(1) The model name, serial No., and software version of the printer set by the Printer Information Store Command ([ESC] IG) is retrieved

[Information field]

Model name	Serial No.
20 bytes	11 bytes

Examples

The following information is stored in the printer.

Model name: B-SV4D-GS10-QM

Serial No.: 2303A000001

Model name: [42H] [2DH] [53H] [56H] [34H] [44H] [2DH] [47H] [53H] [31H] [30H] [2DH] [51H] [4DH] [20H]
[20H] [20H] [20H] [20H] [20H]

Serial No.: [32H] [33H] [30H] [33H] [41H] [30H] [30H] [30H] [30H] [30H] [31H]

Refer to

Printer Information Store Command ([ESC] IG)

6.4 COMMANDS FOR SYSTEM ADMINISTRATOR

6.4.1 PARAMETER SET COMMAND

[ESC] Z2; 1

Function	Sets each parameter on the printer.
Format	[ESC] Z2; 1, abcdefghijklmnopqrst [LF] [NUL]
Term	a: Character code selection 0: PC-850 1: PC-852 2: PC-857 3: PC-8 4: PC-851 5: PC-855 6: PC-1250 7: PC-1251 8: PC-1252 9: PC-1253 A: PC-1254 B: PC-1257 C: LATIN9 D: Arabic b: Font "0" selection 0: 0 (without slash) 1: 0 (with slash) c: RS-232C communication speed 0: 2400 bps 1: 4800 bps 2: 9600 bps 3: 19200 bps 4: 38400 bps 5: 57600 bps d: RS-232C data length 0: 7 bits 1: 8 bits e: Stop bit length 0: 1 bit 1: 2 bits f: RS-232C parity check 0: NONE 1: EVEN 2: ODD

- g: RS-232C transmission control
- 0: XON/XOFF protocol
(No XON output when the power is turned on, no XOFF output when the power is turned OFF)
 - 1: READY/BUSY (DTR) protocol
(No XON output when the power is turned on, no XOFF output when the power is turned OFF)
 - 2: XON/XOFF + READY/BUSY (DTR) protocol:
(XON output when the power is turned on, XOFF output when the power is turned OFF)
 - 3: XON/XOFF protocol:
(XON output when the power is turned on, XOFF output when the power is turned OFF)
 - 4: RTS protocol
(No XON output when the power is turned on, no XOFF output when the power is turned OFF)
- h: Language for LCD messages
- 0: Ignore
 - 1: Ignore
 - 2: Ignore
 - 3: Ignore
 - 4: Ignore
 - 5: Ignore
 - 6: Ignore
- i: Forward feed standby after an issue
- 0: Ignore
 - 1: Ignore
- j: Head up operation after a label is cut
- 0: Ignore
 - 1: Ignore
- k: Ribbon saving system
- 0: Ignore
 - 1: Ignore
- l: Type of control code
- 0: Automatic selection
 - 1: ESC, LF, NUL mode
 - 2: {, |, } mode
- m: Ribbon type selection
- 0: Ignore
 - 1: Ignore
- n: Strip status selection
- 0: Ignore
 - 1: Ignore

- o: [FEED] key function
 - 0: FEED: Feeds one label.
 - 1: PRINT: Prints data from the image buffer on one label.
- p: Kanji code selection
 - 0: Ignore
 - 1: Ignore
- qq: Euro code setting
 - "20" to "FF" (Specify the hex code in 2 bytes of ASCII code) *1
- r: Automatic head broken dots check
 - 0: Ignore
 - 1: Ignore
- s: Centronics ACK/BUSY timing setting
 - 0: Ignore
 - 1: Ignore
- t: Web printer function setting
 - 0: Ignore
 - 1: Ignore

Explanation

- (1) This command is not executed until the printer enters an idle state.
- (2) With some exceptions, the parameters set by this command become effective when the power is turned on or the printer is reset.
- *1: To specify the hex code to be set in 2 bytes of ASCII code as shown below:
 - Example 1: To set 36H: "36" (33H, 36H)
 - Example 2: To set 42H: "42" (34H, 32H)
 - Example 3: To set FFH: "FF" (46H, 46H)

6.4.2 FINE ADJUSTMENT VALUE SET COMMAND

[ESC] Z2; 2

Function	Sets various fine adjustment values on the printer.
Format	[ESC] Z2; 2, abbbcddeffghhhijklmnnoppqrr [LF] [NUL]
Term	<p>a: Indicates the direction, forward or backward, in which a feed length fine adjustment is to be made. +: Ignore -: Ignore</p> <p>bbb: Feed length fine adjustment value Ignore</p> <p>c: Indicates the direction, forward or backward, in which a cut position (or strip position) fine adjustment is to be made. +: Ignore -: Ignore</p> <p>ddd: Fine adjustment value for the cut position (or strip position) Ignore</p> <p>e: Indicates whether the back feed is to be increased or decreased. +: Ignore -: Ignore</p> <p>ff: Back feed length fine adjustment value Ignore</p> <p>g: Indicates the direction, positive or negative, in which the X-coordinate fine adjustment is to be made. +: Positive direction -: Negative direction</p> <p>hhh: X-coordinate fine adjustment value 000 to 995 (in units of 0.5 mm) *1</p> <p>i: Indicates whether to increase or decrease the density in the thermal transfer print mode. +: Ignore -: Ignore</p> <p>jj: Print density fine adjustment value (for the thermal transfer print mode) Ignore</p> <p>k: Indicates whether to increase or decrease the density in the direct thermal print mode. +: Ignore -: Ignore</p> <p>ll: Print density fine adjustment value (for the direct thermal print mode) Ignore</p> <p>m: Fine adjustment direction for the ribbon rewind motor voltage -: Ignore</p> <p>nn: Fine adjustment value for the ribbon rewind motor voltage Ignore</p>

- o: Fine adjustment direction for the ribbon back tension motor voltage
 - +: Ignore
 - : Ignore
- pp: Fine adjustment value for the ribbon back tension motor voltage
 - Ignore
- qq: Reflective sensor manual threshold fine adjustment value
 - Ignore
- rr: Transmissive sensor manual threshold fine adjustment value
 - Ignore
- ss: Sensor sensitivity adjustment value
 - 00 to 63

Explanation

- (1) This command is not executed until the printer enters an idle state.
- (2) With some exceptions, the parameters set by this command become effective when the power is turned on or the printer is reset.
- (3) Sensor sensitivity adjustment value
 - This value is used to adjust the sensor sensitivity. Available values are from 00 to 63 is the lowest sensitivity, while 63 is the highest sensitivity.
 - Normally, the sensor sensitivity can be set automatically when calibrating the sensor. This value can be seen from the self-test printing.
 - For example)
 - `SENSOR TRANSMISSIVE [17]`
 - This means current sensor type is transmissive sensor and sensitivity level is 17. If the automatic sensor calibration cannot register label gap or black mark, use this parameter to adjust sensitivity manually.
- *1: The value can be set in units of 0.1 mm. However, the value which is actually set on the printer is in units of 0.5 mm. When a value from 0.0 mm to 0.4 mm is set, it is actually set on the printer as 0.0 mm. Also when a value from 0.5 mm to 0.9 mm is set, it is actually set on the printer as 0.5 mm.

6.4.3 BATCH RESET COMMAND

[ESC] Z0 ^(zero)

Function	Resets the printer.
Format	[ESC] Z0 [LF] [NUL]
Explanation	<ul style="list-style-type: none">• This command is not executed until the printer enters an idle state.• Some values in the Parameter Set Command ([ESC] Z2;1) and the Fine Adjustment Value Set Command ([ESC] Z2;2), will become effective when the printer is initialized. This command should be sent after the Parameter Set Command ([ESC] Z2;1) or Fine Adjustment Value Set Command ([ESC] Z2;2) is sent.

7. CONTROL CODE SELECTION

(1) Automatic Selection

This printer automatically selects [ESC] (1BH). [LF] (0AH). [NUL] (00H) or {(7BH). | (7CH).} (7DH) as an interface command control code. After the power is turned on, the program checks the data from the host for [ESC] and { and assumes the data whichever has been sent first to be a control code.

For example, if [ESC] is sent first after the power is turned on, [ESC]. [LF]. [NUL] becomes a control code, and if { is sent first, { . | . } becomes a control code. Control code selection is made for every command. If the first command is [ESC] ~ [LF] [NUL], followed by [ESC], the control code becomes [ESC]. [LF]. [NUL], and if it is followed by { , the control code for the next command becomes { . | . }. When { . | . } is a control code, the data of 00H to 1FH in { ~ | } is ignored. However, the data of 00H to 1FH becomes valid while processing the Graphic Command or Writable Character Command in hexadecimal mode. When { . | . } is a control code, { . | . } cannot be used in the data of the Data Command or Display Command.

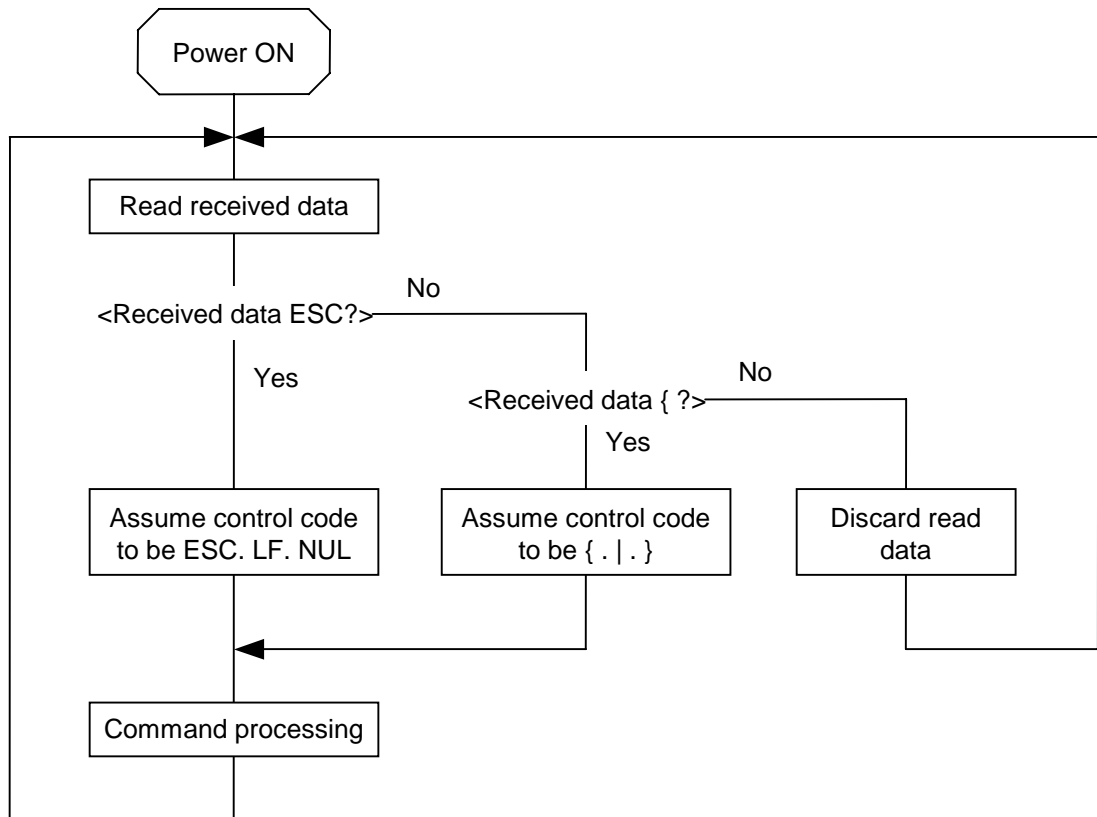

(2) Manual Selection (ESC. LF. NUL)

The control code of the command is [ESC] (1BH). [LF] (0AH). [NUL] (00H), and the control code selection is not performed.

(3) Manual Selection ({ . | . })

The control code of the command is {(7BH). | (7CH).} (7DH), and the control code selection is not performed. Data of 00H to 1FH is ignored and discarded in this mode. However, data of 00H to 1FH becomes valid while processing the Graphic Command or Writable Character Command in hexadecimal mode. { . | . } cannot be used in the data of the Data Command or Display Command.

8. ERROR PROCESSING

If the printer detects any of the following errors, it will display the error message (LED), makes status response (serial interface, parallel interface and USB interface), and stops its operation.

8.1 COMMUNICATION ERRORS

(1) Command Errors

An error results if a command length error, command transmission sequence error, command format error or parameter designation error is found in analyzing the command. An error results if the Format Command of a field is not transmitted and its Data Command is transmitted. When attempting to call a PC Save Command of a save identifier which is not saved, an error results. An undefined command is not detected as an error, and data is discarded until [NUL] or [}] is received.

(2) Hardware Errors

An error results if a framing error, overrun error or parity error is found during data reception when using the serial interface (RS-232C).

* At the moment when a command error or hardware error occurs, the printer shows the error message and makes status response before stopping. The Status Request Command and Reset Command only can be processed and other commands are not processed. When the printer is restored by the [RESTART] key, the printer enters the initial state which is obtained after the power is turned on.

8.2 ERRORS IN ISSUING OR FEEDING

(1) Feed Jam

① When the relation between the programmed label (or tag) pitch (A) and the label (or tag) pitch detected by the sensor (B) is not indicated by the following formula, an error will result: $(A) \times 50\% \leq (B) \leq (A) \times 150\%$

- A paper jam has occurred during paper feed.
- The paper is not placed properly.
- The actual label does not match the type of the sensor.
- The sensor position is not aligned with the black mark.
- The actual label size does not meet the designated label length.
- No label-to-label gap is detected due to preprint.
- The sensor is not thoroughly adjusted.

(The sensor is not adjusted for the label to be used.)

② If the stripped label does not cover the strip sensor when printing or feeding is completed in strip mode, an error will result.

(2) Cutter Error

- Cutter

When the cutter does not move from the cutter home position 50 msec or more after the cutter solenoid is driven, an error will result.

The cutter moves from the home position, however, it does not return to the home position after 500 msec.

(3) Label End

① When the transmissive sensor and reflective sensor detect the label end state in 10 mm continuously, an error will result.

② If the transmissive sensor and reflective sensor detect the label end state when an issue, feed and ejection is attempted in a printer stop state, an error will result.

(4) Head Open Error

If the head open sensor detects the open state when an issue, feed and ejection is attempted in a printer stop state, an error will result.

(5) Thermal Head Excessive Temperature

When the thermal head temperature detection thermistor detects an excessively high temperature, an error will result.

8.3 ERRORS IN WRITABLE CHARACTER AND PC COMMAND SAVE MODES

(1) Write Error

- An error has occurred in writing in the flash memory board.

(2) Format Error

- An erase error has occurred in formatting the flash memory board.

(3) Memory Full

- Storing is impossible because of the insufficient flash memory capacity.

* At the moment when an error occurs, the printer shows the error message, makes status response, then stops. The Status Request Command and Reset Command only can be processed and other commands are not processed. Restoration using the [FEED] key is impossible.

9. STATUS RESPONSE

9.1 SERIAL INTERFACE

9.1.1 FUNCTIONS

There are the following two kinds of status response functions.

- (1) Status transmission function at the end of normal transmission and occurrence of an error (auto status transmission)

If the option for "status response" has been selected, the printer sends status to the host computer when the printer performs a feed or completes an issue normally (For batch/cut mode: after the designated number of labels are printed, For strip mode: after one label is printed). In the online mode, the head up/down status is sent to the host computer.

When each error occurs, the status is sent to the host computer.

The remaining count in the status response indicates the remaining count of the batch currently being printed. No remaining count of the batch waiting to be printed is transmitted.

- (2) Status transmission function by status request (Status Request Command)

Upon request to send status by the Status Request Command, the printer sends the latest status indicating its current state to the host computer, regardless of the option for "status response/no status response". The remaining count indicates the remaining count of the batch currently being printed. No remaining count of the batch waiting to be printed is transmitted. This command is not stored in the receive buffer and executed immediately when it is received.

- Strip status

The strip status (05H) returned by the Status Request Command depends on the system mode setting.

When the strip status of the system mode is set to "1":

If the Status Request Command is sent when a label is on the strip shaft (for example, while idling, after feeding a label, after printing all labels), the printer returns (00H).

When the strip status of the system mode is set to "2":

If the Status Request Command is sent when a label is on the strip shaft (for example, while idling, after feeding a label, after printing all labels), the printer returns (05H).

If the Status Request Command is sent while a label is being printed or issued, the strip status (05H) is returned for both settings.

9.1.2 STATUS FORMAT

SOH	STX	Status			Remaining count				ETX	EOT	CR	LF
01H	02H	3XH	3XH	3XH	3XH	3XH	3XH	3XH	03H	04H	0DH	0AH

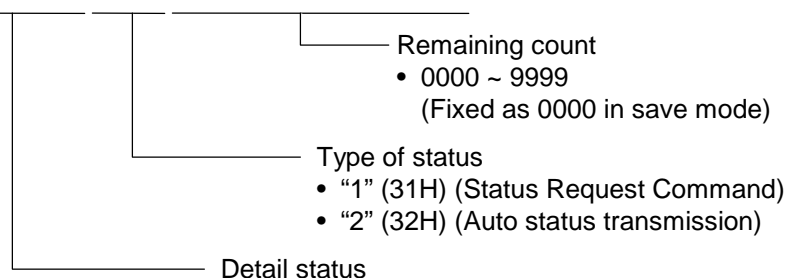

9.1.3 DETAIL STATUS

Printer Status	Detail Status	
	Auto Status Transmission	Status Request Command
The head was closed in the online mode.	00	00
The head was opened in the online mode.	01	01
Operating (Analyzing command, drawing, printing, feeding)	–	02
In pause	–	04
Waiting for stripping	–	05
A command error was found in analyzing the command.	06	06
A parity error, overrun error or framing error occurred during communication by RS-232C	07	07
A paper jam occurred during paper feed.	11	11
An abnormal condition occurred at the cutter.	12	12
The label has run out.	13	13
An attempt was made to feed or issue with the head open. (except the [FEED] key)	15	15
The thermal head temperature has become excessively high.	18	18
A label issue is completed normally.	40	–
The feed has been terminated normally.	41	–
In writable character or PC command save mode	–	02
An error has occurred in writing data into the flash memory board.	50	50
An erase error has occurred in formatting the flash memory board.	51	51
Saving failed because of the insufficient capacity of the flash memory board.	54	54
The flash memory board is being initialized.	–	02
An EEPROM for back up cannot be read/written properly.	02	02

9.2 PARALLEL INTERFACE

Printer Status	Output Signal			
	BUSY	PAUSE	FAULT	PE
In the online mode	L	H	H	L
In the online mode (communicating)	L, H	H	H	L
The head was opened in the online mode.	–	L	L	L
In a pause state	–	L	L	L
Data was set from the host with the receive buffer full.	–	H	H	L
After data was sent from the host with the receive buffer full, some data is processed and room becomes available.	–	H	H	L
Initialize process in execution (After the power is turned on or INIT is received)	–	L	L	L
A command error has occurred in analyzing the command.	–	L	L	L
A paper jam occurred during paper feed.	–	L	L	L
An abnormal condition occurred at the cutter.	–	L	L	L
The label has run out.	–	L	L	H
A feed or an issue was attempted with the head opened. (except the [FEED] key)	–	L	L	L
The thermal head temperature has become excessively high.	–	L	L	L
In writable character or PC command save mode	–	H	H	L
An error has occurred in writing data into the flash memory board.	–	L	L	L
An erase error has occurred in formatting the flash memory board.	–	L	L	L
Saving failed because of the insufficient capacity of the flash memory board.	–	L	L	L
The flash memory card is being initialized. (Initialization is carried out for approximately 15 seconds)	–			
A momentary power interruption has occurred.	–	L	L	L
An EEPROM for back-up cannot be read/written properly.	–	L	L	L

Printer Status	Output Signal			
	BUSY	PAUSE	FAULT	PE
(a) A command has been fetched from an odd address.	–	L	L	L
(b) Word data has been accessed from a place other than the boundary of the word data.				
(c) Long word data has been accessed from a place other than the boundary of the long word data.				
(d) An undefined command in a place other than the delay slot has been decoded.				
(e) An undefined command in the delay slot has been decoded.				
(f) A command which rewrites the data in the delay slot has been decoded.				

10. LED INDICATIONS

No.	LED Indication			Printer Status	Restoration by [FEED] key Yes/No	Acceptance of Status Request Reset Command Yes/No
	Green	Red	Orange			
1	●	×		In the online mode	-	Yes
	✦	×		In the online mode (Communicating)	-	Yes
2	×	×		The head was opened in the online mode.	-	Yes
3	×	×	✦	In a pause state	Yes	Yes
4	×	●		A parity error, overrun error or framing error has occurred during communication by RS-232C.	Yes	Yes
5	×	✦		A paper jam occurred during paper feed.	Yes	Yes
6	×	●		An abnormal condition occurred at the cutter.	Yes	Yes
7	×	✦		The label has run out.	Yes	Yes
8	×	●		A feed or an issue was attempted with the head opened. (except the [FEED] key)	Yes	Yes
9	×	●		The thermal head temperature has become excessively high.	No	Yes
10	✦	×		In writable character or PC command save mode	-	Yes
11	×	●		An error has occurred in writing data into the flash memory board.	No	Yes
12	×	●		An erase error has occurred in formatting the flash memory board.	No	Yes
13	×	●		Saving failed because of the insufficient capacity of the flash memory card.	No	Yes
14	×	×	●	The flash memory board is being initialized. (Initialization is carried out for approximately 15 seconds)	-	-
15	×	●		An EEPROM for back-up cannot be read/written properly.	No	No

No.	LED Indication			Printer Status	Restoration by [FEED] key Yes/No	Acceptance of Status Request Reset Command Yes/No
	Green	Red	Orange			
16	✕	●		(a) A command has been fetched from an odd address. (b) Word data has been accessed from a place other than the boundary of the word data. (c) Long word data has been accessed from a place other than the boundary of the long word data. (d) An undefined command in a place other than the delay slot has been decoded. (e) An undefined command in the delay slot has been decoded. (f) A command which rewrites the data in the delay slot has been decoded.	No	No

NOTE 1: ● : On
 ✕ : Off

11. CHARACTER CODE TABLE

The followings are the character code tables. However, the characters which can be printed are different according to the character type. For the character which can be printed, refer to the print sample described later.

11.1 TIMES ROMAN, HELVETICA, LETTER GOTHIC, PRESTIGE ELITE, COURIER

(Bit map font type: E, J, N, O, Q)

(1) PC-850

	0	1	2	3	4	5	6	7	8	9	A	B	C	D	E	F
0				0	@	P	`	p	Ç	É	á	€		ð	Ó	-
1			!	1	A	Q	a	q	ü	æ	í			Ð	ß	±
2			"	2	B	R	b	r	é	Æ	ó			Ê	Ô	=
3			#	3	C	S	c	s	â	ô	ú			Ë	Ò	¾
4			\$	4	D	T	d	t	ä	ö	ñ			È	õ	¶
5			%	5	E	U	e	u	à	ò	Ñ	Á		1	Õ	§
6			&	6	F	V	f	v	â	û	ª	Â	ã	í	µ	÷
7			'	7	G	W	g	w	ç	ù	º	À	Ã	î	þ	,
8			(8	H	X	h	x	ê	ÿ	¿	©		ï	þ	°
9)	9	I	Y	i	y	ë	Ö	®			Ú	¨	
A			*	:	J	Z	j	z	è	Ü	¬			Û	•	
B			+	;	K	[k	{	ï	ø	½			Ù	1	
C			,	<	L	\	l		î	£	¼			ý	3	
D			-	=	M]	m	}	ì	∅	¡	¢		ÿ	2	
E			.	>	N	^	n	~	Ä	x	«	¥		ì		■
F			/	?	O	_	o	¸	Å	f	»		¤			

The Euro code (B0H) can be changed in the parameter setting on Z2;1 command.

(2) PC-8

	0	1	2	3	4	5	6	7	8	9	A	B	C	D	E	F
0				0	@	P	`	p	Ç	É	á	€			α	≡
1			!	1	A	Q	a	q	ü	æ	í				β	±
2			"	2	B	R	b	r	é	Æ	ó				Γ	≥
3			#	3	C	S	c	s	â	ô	ú				π	≤
4			\$	4	D	T	d	t	ä	ö	ñ				Σ	
5			%	5	E	U	e	u	à	ò	Ñ				σ]
6			&	6	F	V	f	v	â	û	ª				µ	÷
7			'	7	G	W	g	w	ç	ù	º				τ	≈
8			(8	H	X	h	x	ê	ÿ	¿				Φ	°
9)	9	I	Y	i	y	ë	Ö	¬				Θ	•
A			*	:	J	Z	j	z	è	Ü	¬				Ω	•
B			+	;	K	[k	{	ï	¢	½				δ	√
C			,	<	L	\	l		î	£	¼				∞	n
D			-	=	M]	m	}	ì	¥	¡				∅	2
E			.	>	N	^	n	~	Ä	Pt	«				ε	■
F			/	?	O	_	o	¸	Å]	»				∩	

The Euro code (B0H) can be changed in the parameter setting on Z2;1 command.

(3) PC-852

	0	1	2	3	4	5	6	7	8	9	A	B	C	D	E	F
0			0	@	P	`	p	Ç	É	á	€			Ó	-	
1		!	1	A	Q	a	q	ü		í			Đ	ß		
2		"	2	B	R	b	r	é		ó				Ô		
3		#	3	C	S	c	s	â	ô	ú			Ë			
4		\$	4	D	T	d	t	ä	ö							
5		%	5	E	U	e	u				Á					§
6		&	6	F	V	f	v				Â			Í		÷
7		'	7	G	W	g	w	ç						Î		ˆ
8		(8	H	X	h	x									°
9)	9	I	Y	i	y	ë	Ö					Ú		¨
A		*	:	J	Z	j	z		Ü	¬						•
B		+	;	K	[k	{									
C		,	<	L	\	l		î							ý	
D		-	=	M]	m	}								ÿ	
E		.	>	N	^	n	~	Ä	x	«						■
F		/	?	O	_	o	⌘			»		¤				

The Euro code (B0H) can be changed in the parameter setting on Z2;1 command.

(4) PC-857

	0	1	2	3	4	5	6	7	8	9	A	B	C	D	E	F
0			0	@	P	`	p	Ç	É	á	€		º	Ó	-	
1		!	1	A	Q	a	q	ü	æ	í			ª	ß	±	
2		"	2	B	R	b	r	é	Æ	ó			Ê	Ô		
3		#	3	C	S	c	s	â	ô	ú			Ë	Ò	¾	
4		\$	4	D	T	d	t	ä	ö	ñ			È	õ	¶	
5		%	5	E	U	e	u	à	ò	Ñ	Á			Ö	§	
6		&	6	F	V	f	v	â	û		Â	ã	Í	µ	÷	
7		'	7	G	W	g	w	ç	ù		À	Ã	Î		ˆ	
8		(8	H	X	h	x	ê		¿	©			Ï	˚	°
9)	9	I	Y	i	y	ë	Ö	®				Ú		¨
A		*	:	J	Z	j	z	è	Ü	¬				Û		•
B		+	;	K	[k	{	ï	ø	½				Ü		1
C		,	<	L	\	l		î	£	¼				ì		3
D		-	=	M]	m	}		Ø	¡	¢		!	ÿ		2
E		.	>	N	^	n	~	Ä		«	¥		!	ÿ		■
F		/	?	O	_	o	⌘	Å		»		¤		'		

The Euro code (B0H) can be changed in the parameter setting on Z2;1 command.

(5) PC-851

	0	1	2	3	4	5	6	7	8	9	A	B	C	D	E	F
0				0	@	P	`	p	Ç			€				
1			!	1	A	Q	a	q	ü							±
2			"	2	B	R	b	r	é							
3			#	3	C	S	c	s	â	ô						
4			\$	4	D	T	d	t	ä	ö						
5			%	5	E	U	e	u	à							§
6			&	6	F	V	f	v		û						
7			'	7	G	W	g	w	ç	ù						
8			(8	H	X	h	x	ê							°
9)	9	I	Y	i	y	ë	Ö						¨
A			*	:	J	Z	j	z	è	Ü						
B			+	;	K	[k	{	ï		½					
C			,	<	L	\	l		î	£						
D			-	=	M]	m	}								
E			.	>	N	^	n	~	Ä		«					■
F			/	?	O	_	o	⌘			»					

The Euro code (B0H) can be changed in the parameter setting on Z2;1 command.

(6) PC-855

	0	1	2	3	4	5	6	7	8	9	A	B	C	D	E	F
0				0	@	P	`	p				€				
1			!	1	A	Q	a	q								
2			"	2	B	R	b	r								
3			#	3	C	S	c	s								
4			\$	4	D	T	d	t								
5			%	5	E	U	e	u								
6			&	6	F	V	f	v								
7			'	7	G	W	g	w								
8			(8	H	X	h	x								
9)	9	I	Y	i	y								
A			*	:	J	Z	j	z								
B			+	;	K	[k	{								
C			,	<	L	\	l									
D			-	=	M]	m	}								§
E			.	>	N	^	n	~			«					■
F			/	?	O	_	o	⌘			»		¤			

The Euro code (B0H) can be changed in the parameter setting on Z2;1 command.

(7) PC-1250

	0	1	2	3	4	5	6	7	8	9	A	B	C	D	E	F
0			0	@	P	`	p					€				
1		!	1	A	Q	a	q					±	Á		á	
2		"	2	B	R	b	r						Â		â	
3		#	3	C	S	c	s							Ó		ó
4		\$	4	D	T	d	t			¤	'	Ä	Ö	ä	ö	
5		%	5	E	U	e	u				μ					
6		&	6	F	V	f	v			¡	¶		Ö		ö	
7		'	7	G	W	g	w			§	·	Ç	x	ç	÷	
8		(8	H	X	h	x			"	,					
9)	9	I	Y	i	y			©			É		é	
A		*	:	J	Z	j	z						Ú		ú	
B		+	;	K	[k	{			«	»		Ë		ë	
C		,	<	L	\	l				¬			Ü		ü	
D		-	=	M]	m	}						Í	Ý	í	ý
E		.	>	N	^	n	~			®			Î		î	
F		/	?	O	_	o	⌘							ß		

The Euro code (B0H) can be changed in the parameter setting on Z2;1 command.

(8) PC-1251

	0	1	2	3	4	5	6	7	8	9	A	B	C	D	E	F
0			0	@	P	`	p					€				
1		!	1	A	Q	a	q					±				
2		"	2	B	R	b	r									
3		#	3	C	S	c	s									
4		\$	4	D	T	d	t			¤						
5		%	5	E	U	e	u				μ					
6		&	6	F	V	f	v			¡	¶					
7		'	7	G	W	g	w			§	·					
8		(8	H	X	h	x									
9)	9	I	Y	i	y			©						
A		*	:	J	Z	j	z									
B		+	;	K	[k	{			«	»					
C		,	<	L	\	l				¬						
D		-	=	M]	m	}									
E		.	>	N	^	n	~			®						
F		/	?	O	_	o	⌘									

The Euro code (B0H) can be changed in the parameter setting on Z2;1 command.

(9) PC-1252

	0	1	2	3	4	5	6	7	8	9	A	B	C	D	E	F
0			0	@	P	`	p				€	À	Ð	à	ð	
1		!	1	A	Q	a	q				ì	±	Á	Ñ	á	ñ
2		"	2	B	R	b	r				¢	²	Â	Ò	â	ò
3		#	3	C	S	c	s	<i>f</i>			£	³	Ã	Ó	ã	ó
4		\$	4	D	T	d	t				¤	´	Ä	Ô	ä	ô
5		%	5	E	U	e	u				¥	µ	Å	Õ	å	õ
6		&	6	F	V	f	v				¦	¶	Æ	Ö	æ	ö
7		'	7	G	W	g	w				§	·	Ç	×	ç	÷
8		(8	H	X	h	x	^	~		¨	,	È	Ø	è	ø
9)	9	I	Y	i	y				©	¹	É	Ù	é	ù
A		*	:	J	Z	j	z				ª	º	Ê	Ú	ê	ú
B		+	;	K	[k	{				«	»	Ë	Û	ë	û
C		,	<	L	\	l					¬	¼	Ì	Ü	ì	ü
D		-	=	M]	m	}					½	Í	Ý	í	ý
E		.	>	N	^	n	~				®	¾	Î	Þ	î	þ
F		/	?	O	_	o	⌘				¿	¿	Ï	ß	ï	ÿ

The Euro code (B0H) can be changed in the parameter setting on Z2;1 command.

(10) PC-1253

	0	1	2	3	4	5	6	7	8	9	A	B	C	D	E	F
0			0	@	P	`	p				€					
1		!	1	A	Q	a	q					±				
2		"	2	B	R	b	r					²				
3		#	3	C	S	c	s	<i>f</i>			£	³				
4		\$	4	D	T	d	t				¤					
5		%	5	E	U	e	u				¥	µ				
6		&	6	F	V	f	v				¦	¶				
7		'	7	G	W	g	w				§	·				
8		(8	H	X	h	x				¨					
9)	9	I	Y	i	y				©					
A		*	:	J	Z	j	z				ª					
B		+	;	K	[k	{				«	»				
C		,	<	L	\	l					¬					
D		-	=	M]	m	}					½				
E		.	>	N	^	n	~				®					
F		/	?	O	_	o	⌘									

The Euro code (B0H) can be changed in the parameter setting on Z2;1 command.

(11) PC-1254

	0	1	2	3	4	5	6	7	8	9	A	B	C	D	E	F
0			0	@	P	`	p				€	À		à		
1		!	1	A	Q	a	q				±	Á	Ñ	á	ñ	
2		"	2	B	R	b	r			¢	²	Â	Ò	â	ò	
3		#	3	C	S	c	s	f		£	³	Ã	Ó	ã	ó	
4		\$	4	D	T	d	t			¤	´	Ä	Ô	ä	ô	
5		%	5	E	U	e	u			¥	µ	Å	Õ	å	õ	
6		&	6	F	V	f	v			¦	¶	Æ	Ö	æ	ö	
7		'	7	G	W	g	w			§	·	Ç	×	ç	÷	
8		(8	H	X	h	x	^	~	¨	¸	È	Ø	è	ø	
9)	9	I	Y	i	y			©	¹	É	Ù	é	ù	
A		*	:	J	Z	j	z			ª	º	Ê	Ú	ê	ú	
B		+	;	K	[k	{			«	»	Ë	Û	ë	û	
C		,	<	L	\	l				¬	¼	Ì	Ü	ì	ü	
D		-	=	M]	m	}				½	Í		í	¹	
E		.	>	N	^	n	~			®	¾	Î		î		
F		/	?	O	_	o	¸				¿	Ï	ß	ï	ÿ	

The Euro code (B0H) can be changed in the parameter setting on Z2;1 command.

(12) PC-1257

	0	1	2	3	4	5	6	7	8	9	A	B	C	D	E	F
0			0	@	P	`	p				€					
1		!	1	A	Q	a	q				±					
2		"	2	B	R	b	r			¢	²					
3		#	3	C	S	c	s			£	³		Ó		ó	
4		\$	4	D	T	d	t			¤	´	Ä		ä		
5		%	5	E	U	e	u				µ	Å	Õ	å	õ	
6		&	6	F	V	f	v			¦	¶		Ö		ö	
7		'	7	G	W	g	w			§	·		×		÷	
8		(8	H	X	h	x			Ø	ø					
9)	9	I	Y	i	y			©	¹	É		é		
A		*	:	J	Z	j	z									
B		+	;	K	[k	{			«	»					
C		,	<	L	\	l				¬	¼		Ü		ü	
D		-	=	M]	m	}		¨	¸	½					
E		.	>	N	^	n	~			®	¾					
F		/	?	O	_	o	¸			Æ	æ		ß			

The Euro code (B0H) can be changed in the parameter setting on Z2;1 command.

(13) LATIN9

	0	1	2	3	4	5	6	7	8	9	A	B	C	D	E	F
0			0	@	P	`	p				€	À	Ð	à	ð	
1		!	1	A	Q	a	q				ı	±	Á	Ñ	á	ñ
2		"	2	B	R	b	r				¢	²	Â	Ò	â	ò
3		#	3	C	S	c	s				£	³	Ã	Ó	ã	ó
4		\$	4	D	T	d	t				€		Ä	Ô	ä	ô
5		%	5	E	U	e	u				¥	μ	Å	Õ	å	õ
6		&	6	F	V	f	v					¶	Æ	Ö	æ	ö
7		'	7	G	W	g	w				§	·	Ç	x	ç	÷
8		(8	H	X	h	x						È	Ø	è	ø
9)	9	I	Y	i	y				©	¹	É	Ù	é	ù
A		*	:	J	Z	j	z				ª	º	Ê	Ú	ê	ú
B		+	;	K	[k	{				«	»	Ë	Û	ë	û
C		,	<	L	\	l					¬		Ì	Ü	ì	ü
D		-	=	M]	m	}						Í	Ý	í	ý
E		.	>	N	^	n	~				®		Î	Þ	î	þ
F		/	?	O	_	o	⌘					¿	Ï	ß	ï	ÿ

The Euro code (B0H) can be changed in the parameter setting on Z2;1 command.

(14) Arabic

	0	1	2	3	4	5	6	7	8	9	A	B	C	D	E	F
0			0	@	P	`	p				€					
1		!	1	A	Q	a	q									
2		"	2	B	R	b	r									
3		#	3	C	S	c	s									
4		\$	4	D	T	d	t									
5		%	5	E	U	e	u									
6		&	6	F	V	f	v									
7		'	7	G	W	g	w									
8		(8	H	X	h	x									
9)	9	I	Y	i	y									
A		*	:	J	Z	j	z									
B		+	;	K	[k	{									
C		,	<	L	\	l										
D		-	=	M]	m	}									
E		.	>	N	^	n	~									
F		/	?	O	_	o	⌘									

The Euro code (B0H) can be changed in the parameter setting on Z2;1 command.

11.2 PRESENTATION (Bit map font type: M)

(1) PC-850, PC-857

	0	1	2	3	4	5	6	7	8	9	A	B	C	D	E	F
0				0	@	P	`	´				€				-
1			!	1	A	Q	A	Q								
2			"	2	B	R	B	R								
3			#	3	C	S	C	S								
4			\$	4	D	T	D	T								
5			%	5	E	U	E	U								
6			&	6	F	V	F	V								
7			'	7	G	W	G	W								
8			(8	H	X	H	X								
9)	9	I	Y	I	Y								
A			.	:	J	Z	J	Z								
B			+	;	K	[K	{								
C			,	<	L	\	L									
D			-	=	M]	M	}								
E			.	>	N	^	N	~				¥				
F			/	?	O	_	O	⌘								

The Euro code (B0H) can be changed in the parameter setting on Z2;1 command.

(2) PC-8

	0	1	2	3	4	5	6	7	8	9	A	B	C	D	E	F
0				0	@	P	`	´				€				
1			!	1	A	Q	A	Q								
2			"	2	B	R	B	R								
3			#	3	C	S	C	S								
4			\$	4	D	T	D	T								
5			%	5	E	U	E	U								
6			&	6	F	V	F	V								
7			'	7	G	W	G	W								
8			(8	H	X	H	X								
9)	9	I	Y	I	Y								
A			.	:	J	Z	J	Z								
B			+	;	K	[K	{								
C			,	<	L	\	L									
D			-	=	M]	M	}		¥						
E			.	>	N	^	N	~								
F			/	?	O	_	O									

The Euro code (B0H) can be changed in the parameter setting on Z2;1 command.

(3) PC-852

	0	1	2	3	4	5	6	7	8	9	A	B	C	D	E	F
0				0	@	P	`	P				€				-
1			!	1	A	Q	A	Q								
2			"	2	B	R	B	R								
3			#	3	C	S	C	S								
4			\$	4	D	T	D	T								
5			%	5	E	U	E	U								
6			&	6	F	V	F	V								
7			'	7	G	W	G	W								
8			(8	H	X	H	X								
9)	9	I	Y	I	Y								
A			.	:	J	Z	J	Z								
B			+	;	K	[K	{								
C			,	<	L	\	L									
D			-	=	M]	M	}								
E			.	>	N	^	N	~								
F			/	?	O	_	O									

The Euro code (B0H) can be changed in the parameter setting on Z2;1 command.

(4) PC-851, PC-855, PC-1250, PC-1251, PC-1257, Arabic

	0	1	2	3	4	5	6	7	8	9	A	B	C	D	E	F
0				0	@	P	`	P				€				
1			!	1	A	Q	A	Q								
2			"	2	B	R	B	R								
3			#	3	C	S	C	S								
4			\$	4	D	T	D	T								
5			%	5	E	U	E	U								
6			&	6	F	V	F	V								
7			'	7	G	W	G	W								
8			(8	H	X	H	X								
9)	9	I	Y	I	Y								
A			.	:	J	Z	J	Z								
B			+	;	K	[K	{								
C			,	<	L	\	L									
D			-	=	M]	M	}								
E			.	>	N	^	N	~								
F			/	?	O	_	O	█								

The Euro code (B0H) can be changed in the parameter setting on Z2;1 command.

(5) PC-1252, PC-1254

	0	1	2	3	4	5	6	7	8	9	A	B	C	D	E	F
0				0	@	P	`	P				€				
1			!	1	A	Q	A	Q								
2			"	2	B	R	B	R								
3			#	3	C	S	C	S								
4			\$	4	D	T	D	T								
5			%	5	E	U	E	U			¥					
6			&	6	F	V	F	V								
7			'	7	G	W	G	W								
8			(8	H	X	H	X	^	~						
9)	9	I	Y	I	Y								
A			.	:	J	Z	J	Z								
B			+	;	K	[K	{								
C			,	<	L	\	L									
D			-	=	M]	M	}								
E			.	>	N	^	N	~								
F			/	?	O	_	O	█								

The Euro code (B0H) can be changed in the parameter setting on Z2;1 command.

(6) PC-1253

	0	1	2	3	4	5	6	7	8	9	A	B	C	D	E	F
0				0	@	P	`	P				€				-
1			!	1	A	Q	A	Q								
2			"	2	B	R	B	R								
3			#	3	C	S	C	S								
4			\$	4	D	T	D	T								
5			%	5	E	U	E	U			¥					
6			&	6	F	V	F	V								
7			'	7	G	W	G	W								
8			(8	H	X	H	X								
9)	9	I	Y	I	Y								
A			.	:	J	Z	J	Z								
B			+	;	K	[K	{								
C			,	<	L	\	L									
D			-	=	M]	M	}								
E			.	>	N	^	N	~								
F			/	?	O	_	O	█								

The Euro code (B0H) can be changed in the parameter setting on Z2;1 command.

(7) LATIN9

	0	1	2	3	4	5	6	7	8	9	A	B	C	D	E	F
0				0	@	P	`	P				€				
1			!	1	A	Q	A	Q								
2			"	2	B	R	B	R								
3			#	3	C	S	C	S								
4			\$	4	D	T	D	T			€					
5			%	5	E	U	E	U			¥					
6			&	6	F	V	F	V								
7			'	7	G	W	G	W								
8			(8	H	X	H	X								
9)	9	I	Y	I	Y								
A			.	:	J	Z	J	Z								
B			+	;	K	[K	{								
C			,	<	L	\	L									
D			-	=	M]	M	}								
E			.	>	N	^	N	~								
F			/	?	O	_	O	█								

The Euro code (B0H) can be changed in the parameter setting on Z2;1 command.

11.3 TEC OUTLINE FONT 1 (Outline font type: A, B)

(1) PC-850

	0	1	2	3	4	5	6	7	8	9	A	B	C	D	E	F
0			0	@	P	`	p	Ç	É	á	€					-
1		!	1	A	Q	a	q	ü	æ	í	€				ß	±
2		"	2	B	R	b	r	é	Æ	ó						
3		#	3	C	S	c	s	â	ô	ú						
4		\$	4	D	T	d	t	ä	ö	ñ					õ	
5		%	5	E	U	e	u	à	ò	Ñ						§
6		&	6	F	V	f	v	â	û	ª		ã		µ	÷	
7		'	7	G	W	g	w	ç	ù	º						
8		(8	H	X	h	x	ê	ÿ	¿						°
9)	9	I	Y	i	y	ë	Ö							
A		*	:	J	Z	j	z	è	Ü	¬						•
B		+	;	K	[k	{	ï	ø	½						
C		,	<	L	\	l		î	£	¼						
D		-	=	M]	m	}	ì	Ø	¡	¢					²
E		.	>	N	^	n	~	Ä		«	¥					■
F		/	?	O	_	o	△	Å	f	»		¤				

The Euro code (B0H) can be changed in the parameter setting on Z2;1 command.

(2) PC-8

	0	1	2	3	4	5	6	7	8	9	A	B	C	D	E	F
0			0	@	P	`	p	Ç	É	á	€				α	≡
1		!	1	A	Q	a	q	ü	æ	í	€				β	±
2		"	2	B	R	b	r	é	Æ	ó					Γ	≥
3		#	3	C	S	c	s	â	ô	ú					π	≤
4		\$	4	D	T	d	t	ä	ö	ñ					Σ	∫
5		%	5	E	U	e	u	à	ò	Ñ					σ	∫
6		&	6	F	V	f	v	â	û	ª					µ	÷
7		'	7	G	W	g	w	ç	ù	º					τ	≈
8		(8	H	X	h	x	ê	ÿ	¿					Φ	°
9)	9	I	Y	i	y	ë	Ö						Θ	•
A		*	:	J	Z	j	z	è	Ü	¬					Ω	•
B		+	;	K	[k	{	ï	ø	½					δ	√
C		,	<	L	\	l		î	£	¼					∞	n
D		-	=	M]	m	}	ì	¥	¡					∅	²
E		.	>	N	^	n	~	Ä	Pt	«					ε	■
F		/	?	O	_	o	△	Å	∫	»					∩	

The Euro code (B0H) can be changed in the parameter setting on Z2;1 command.

(3) PC-852

	0	1	2	3	4	5	6	7	8	9	A	B	C	D	E	F
0			0	@	P	`	p	Ç	É	á	€					-
1		!	1	A	Q	a	q	ü		í	€				ß	
2		"	2	B	R	b	r	é		ó						
3		#	3	C	S	c	s	â	ô	ú						
4		\$	4	D	T	d	t	ä	ö							
5		%	5	E	U	e	u									§
6		&	6	F	V	f	v									÷
7		'	7	G	W	g	w	ç								
8		(8	H	X	h	x									°
9)	9	I	Y	i	y	ë	Ö							
A		*	:	J	Z	j	z		Ü	¬						•
B		+	;	K	[k	{									
C		,	<	L	\	l		î								
D		-	=	M]	m	}									
E		.	>	N	^	n	~	Ä		«						■
F		/	?	O	_	o	△			»		¤				

The Euro code (B0H) can be changed in the parameter setting on Z2;1 command.

(4) PC-857

	0	1	2	3	4	5	6	7	8	9	A	B	C	D	E	F
0			0	@	P	`	p	Ç	É	á	€		º			-
1		!	1	A	Q	a	q	ü	æ	í	€		ª	ß	±	
2		"	2	B	R	b	r	é	Æ	ó						
3		#	3	C	S	c	s	â	ô	ú						
4		\$	4	D	T	d	t	ä	ö	ñ				õ		
5		%	5	E	U	e	u	à	ò	Ñ						§
6		&	6	F	V	f	v	å	û			ã		µ	÷	
7		'	7	G	W	g	w	ç	ù							
8		(8	H	X	h	x	ê		¿						°
9)	9	I	Y	i	y	ë	Ö							
A		*	:	J	Z	j	z	è	Ü	¬						•
B		+	;	K	[k	{	ï	ø	½						
C		,	<	L	\	l		î	£	¼					ì	
D		-	=	M]	m	}		Ø	ı	¢				ÿ	₂
E		.	>	N	^	n	~	Ä		«	¥					■
F		/	?	O	_	o		Å		»		¤				

The Euro code (B0H) can be changed in the parameter setting on Z2;1 command.

(5) PC-851

	0	1	2	3	4	5	6	7	8	9	A	B	C	D	E	F
0				0	@	P	`	p	Ç			€				
1			!	1	A	Q	a	q	ü			€				±
2			"	2	B	R	b	r	é							
3			#	3	C	S	c	s	â	ô						
4			\$	4	D	T	d	t	ä	ö						
5			%	5	E	U	e	u	à							§
6			&	6	F	V	f	v		û						
7			'	7	G	W	g	w	ç	ù						
8			(8	H	X	h	x	ê							°
9)	9	I	Y	i	y	ë	Ö						
A			*	:	J	Z	j	z	è	Ü						
B			+	;	K	[k	{	ï		½					
C			,	<	L	\	l		î	£						
D			-	=	M]	m	}								
E			.	>	N	^	n	~	Ä		«					■
F			/	?	O	_	o	△			»					

The Euro code (B0H) can be changed in the parameter setting on Z2;1 command.

(6) PC-855

	0	1	2	3	4	5	6	7	8	9	A	B	C	D	E	F
0				0	@	P	`	p				€				
1			!	1	A	Q	a	q				€				
2			"	2	B	R	b	r								
3			#	3	C	S	c	s								
4			\$	4	D	T	d	t								
5			%	5	E	U	e	u								
6			&	6	F	V	f	v								
7			'	7	G	W	g	w								
8			(8	H	X	h	x								
9)	9	I	Y	i	y								
A			*	:	J	Z	j	z								
B			+	;	K	[k	{								
C			,	<	L	\	l									
D			-	=	M]	m	}								§
E			.	>	N	^	n	~			«					■
F			/	?	O	_	o	△			»		¤			

The Euro code (B0H) can be changed in the parameter setting on Z2;1 command.

(7) PC-1250

	0	1	2	3	4	5	6	7	8	9	A	B	C	D	E	F
0				0	@	P	`	p				€				
1			!	1	A	Q	a	q				€			á	
2			"	2	B	R	b	r							â	
3			#	3	C	S	c	s								ó
4			\$	4	D	T	d	t			¤		Ä		ä	ô
5			%	5	E	U	e	u				μ				
6			&	6	F	V	f	v						Ö		ö
7			'	7	G	W	g	w			§	·	Ç		ç	÷
8			(8	H	X	h	x								
9)	9	I	Y	i	y					É		é	
A			*	:	J	Z	j	z								ú
B			+	;	K	[k	{			«	»			ë	
C			,	<	L	\	l				¬			Ü		ü
D			-	=	M]	m	}							í	
E			.	>	N	^	n	~							î	
F			/	?	O	_	o	△						ß		

The Euro code (B0H) can be changed in the parameter setting on Z2;1 command.

(8) PC-1251

	0	1	2	3	4	5	6	7	8	9	A	B	C	D	E	F
0				0	@	P	`	p				€				
1			!	1	A	Q	a	q				€				
2			"	2	B	R	b	r								
3			#	3	C	S	c	s								
4			\$	4	D	T	d	t			¤					
5			%	5	E	U	e	u				μ				
6			&	6	F	V	f	v								
7			'	7	G	W	g	w			§	·				
8			(8	H	X	h	x								
9)	9	I	Y	i	y								
A			*	:	J	Z	j	z								
B			+	;	K	[k	{			«	»				
C			,	<	L	\	l				¬					
D			-	=	M]	m	}								
E			.	>	N	^	n	~								
F			/	?	O	_	o	△								

The Euro code (B0H) can be changed in the parameter setting on Z2;1 command.

(9) PC-1252

	0	1	2	3	4	5	6	7	8	9	A	B	C	D	E	F
0				0	@	P	`	p				€			à	
1			!	1	A	Q	a	q			ı	€		Ñ	á	ñ
2			"	2	B	R	b	r			ç	²			â	ò
3			#	3	C	S	c	s	f		£				ã	ó
4			\$	4	D	T	d	t			¤		Ä		ä	ô
5			%	5	E	U	e	u			¥	μ	Å		å	õ
6			&	6	F	V	f	v					Æ	Ö	æ	ö
7			'	7	G	W	g	w			§	.	Ç		ç	÷
8			(8	H	X	h	x	^	~				Ø	è	ø
9)	9	I	Y	i	y							é	ù
A			*	:	J	Z	j	z			a				ê	ú
B			+	;	K	[k	{			«	»			ë	û
C			,	<	L	\	l				¬	¼		Ü	ì	ü
D			-	=	M]	m	}				½			í	
E			.	>	N	^	n	~							î	
F			/	?	O	_	o	△				ı		ß	ï	ÿ

The Euro code (B0H) can be changed in the parameter setting on Z2;1 command.

(10) PC-1253

	0	1	2	3	4	5	6	7	8	9	A	B	C	D	E	F
0				0	@	P	`	p				€				
1			!	1	A	Q	a	q				€				
2			"	2	B	R	b	r				²				
3			#	3	C	S	c	s	f		£					
4			\$	4	D	T	d	t			¤					
5			%	5	E	U	e	u			¥	μ				
6			&	6	F	V	f	v								
7			'	7	G	W	g	w			§	.				
8			(8	H	X	h	x								
9)	9	I	Y	i	y								
A			*	:	J	Z	j	z			a					
B			+	;	K	[k	{			«	»				
C			,	<	L	\	l				¬					
D			-	=	M]	m	}				½				
E			.	>	N	^	n	~								
F			/	?	O	_	o	△								

The Euro code (B0H) can be changed in the parameter setting on Z2;1 command.

(11) PC-1254

	0	1	2	3	4	5	6	7	8	9	A	B	C	D	E	F
0				0	@	P	`	p				€			à	
1			!	1	A	Q	a	q			ı	€		Ñ	á	ñ
2			"	2	B	R	b	r			ç	²			â	ò
3			#	3	C	S	c	s	f		£				ã	ó
4			\$	4	D	T	d	t			¤		Ä		ä	ô
5			%	5	E	U	e	u			¥	μ	Å		å	õ
6			&	6	F	V	f	v					Æ	Ö	æ	ö
7			'	7	G	W	g	w			§	·	Ç		ç	÷
8			(8	H	X	h	x	^	~				Ø	è	ø
9)	9	I	Y	i	y					É		é	ù
A			*	:	J	Z	j	z			ª	º			ê	ú
B			+	;	K	[k	{			«	»			ë	û
C			,	<	L	\	l				¬	¼		Ü	ì	ü
D			-	=	M]	m	}				½			í	
E			.	>	N	^	n	~							î	
F			/	?	O	_	o	△				ı		ß	ï	ÿ

The Euro code (B0H) can be changed in the parameter setting on Z2;1 command.

(12) PC-1257

	0	1	2	3	4	5	6	7	8	9	A	B	C	D	E	F
0				0	@	P	`	p				€				
1			!	1	A	Q	a	q				€				
2			"	2	B	R	b	r			ç	²				
3			#	3	C	S	c	s			£					ó
4			\$	4	D	T	d	t			¤		Ä		ä	
5			%	5	E	U	e	u				μ	Å		å	õ
6			&	6	F	V	f	v						Ö		ö
7			'	7	G	W	g	w			§	·				÷
8			(8	H	X	h	x			Ø	ø				
9)	9	I	Y	i	y					É		é	
A			*	:	J	Z	j	z								
B			+	;	K	[k	{			«	»				
C			,	<	L	\	l				¬	¼		Ü		ü
D			-	=	M]	m	}				½				
E			.	>	N	^	n	~								
F			/	?	O	_	o	△			Æ	æ		ß		

The Euro code (B0H) can be changed in the parameter setting on Z2;1 command.

(13) LATIN9

	0	1	2	3	4	5	6	7	8	9	A	B	C	D	E	F
0				0	@	P	`	p				€			à	
1			!	1	A	Q	a	q			ı	€		Ñ	á	ñ
2			"	2	B	R	b	r			ç	²			â	ò
3			#	3	C	S	c	s			£				ã	ó
4			\$	4	D	T	d	t			¤		Ä		ä	ô
5			%	5	E	U	e	u			¥	µ	Å		å	õ
6			&	6	F	V	f	v					Æ	Ö	æ	ö
7			'	7	G	W	g	w			§	·	Ç		ç	÷
8			(8	H	X	h	x						Ø	è	ø
9)	9	I	Y	i	y					É		é	ù
A			*	:	J	Z	j	z			ª	º			ê	ú
B			+	;	K	[k	{			«	»			ë	û
C			,	<	L	\	l				¬			Ü	ì	ü
D			-	=	M]	m	}							í	
E			.	>	N	^	n	~							î	
F			/	?	O	_	o					ı		ß	İ	ÿ

The Euro code (B0H) can be changed in the parameter setting on Z2;1 command.

(14) Arabic

	0	1	2	3	4	5	6	7	8	9	A	B	C	D	E	F
0				0	@	P	`	p				€				
1			!	1	A	Q	a	q				€				
2			"	2	B	R	b	r								
3			#	3	C	S	c	s								
4			\$	4	D	T	d	t								
5			%	5	E	U	e	u								
6			&	6	F	V	f	v								
7			'	7	G	W	g	w								
8			(8	H	X	h	x								
9)	9	I	Y	i	y								
A			*	:	J	Z	j	z								
B			+	;	K	[k	{								
C			,	<	L	\	l									
D			-	=	M]	m	}								
E			.	>	N	^	n	~								
F			/	?	O	_	o	△								

The Euro code (B0H) can be changed in the parameter setting on Z2;1 command.

11.4 TrueType FONT

(1) PC-850

	2	3	4	5	6	7	8	9	A	B	C	D	E	F
0	0	@	P	`	p	Ç	É	á	⋮	⊥	ð	Ó	-	
1	!	1	A	Q	a	q	ü	æ	í	⊗	⊥	Ð	β	±
2	"	2	B	R	b	r	é	Æ	ó	⊗	⊥	Ê	Ô	=
3	#	3	C	S	c	s	â	ô	ú		⊥	Ë	Ò	¼
4	\$	4	D	T	d	t	ä	ö	ñ	⊥	—	È	ø	¶
5	%	5	E	U	e	u	à	ò	Ñ	Á	+	ı	Õ	§
6	&	6	F	V	f	v	á	ú	ª	Â	ã	Í	μ	÷
7	'	7	G	W	g	w	ç	ù	º	À	Ã	Î	þ	,
8	(8	H	X	h	x	ê	ÿ	¿	©	⊥	İ	þ	°
9)	9	I	Y	i	y	ë	Ö	®	⊥	⊥	⊥	Ú	¨
A	*	:	J	Z	j	z	è	Ü	¬		⊥	⊥	Û	·
B	+	;	K	[k	{	ï	ø	½	⊥	⊥	■	Ü	¹
C	,	<	L	\	l		î	£	¼	⊥	⊥	■	Ý	³
D	-	=	M]	m	}	ì	Ø	ı	⊥	⊥	⊥	Ÿ	²
E	.	>	N	^	n	~	Ä	×	«	⊥	⊥	⊥	ı	▪
F	/	?	O	_	o	△	Å	f	»	⊥	⊥	■	'	

(2) PC-8

	2	3	4	5	6	7	8	9	A	B	C	D	E	F
0	0	@	P	`	p	Ç	É	á	⋮	⊥	⊥	α	≡	
1	!	1	A	Q	a	q	ü	æ	í	⊗	⊥	⊥	β	±
2	"	2	B	R	b	r	é	Æ	ó	⊗	⊥	⊥	Γ	≥
3	#	3	C	S	c	s	â	ô	ú		⊥	⊥	π	≤
4	\$	4	D	T	d	t	ä	ö	ñ	⊥	—	⊥	Σ	∫
5	%	5	E	U	e	u	à	ò	Ñ	⊥	+	⊥	σ	∫
6	&	6	F	V	f	v	á	ú	ª	⊥	⊥	⊥	μ	÷
7	'	7	G	W	g	w	ç	ù	º	⊥	⊥	⊥	τ	≈
8	(8	H	X	h	x	ê	ÿ	¿	⊥	⊥	⊥	Φ	°
9)	9	I	Y	i	y	ë	Ö	⊥	⊥	⊥	⊥	Θ	·
A	*	:	J	Z	j	z	è	Ü	¬		⊥	⊥	Ω	·
B	+	;	K	[k	{	ï	ı	½	⊥	⊥	■	δ	√
C	,	<	L	\	l		î	£	¼	⊥	⊥	■	∞	n
D	-	=	M]	m	}	ì	¥	ı	⊥	⊥	■	φ	²
E	.	>	N	^	n	~	Ä	Pt	«	⊥	⊥	⊥	ε	▪
F	/	?	O	_	o	△	Å	f	»	⊥	⊥	■	∩	

(3) PC-852

	2	3	4	5	6	7	8	9	A	B	C	D	E	F
0		0	@	P	`	p	Ç	É	á	⋮	↳	đ	Ó	-
1	!	1	A	Q	a	q	ü	Í	í	⊞	↳	Đ	β	~
2	"	2	B	R	b	r	é	í	ó	⊞	↳	Ď	Ô	.
3	#	3	C	S	c	s	â	ô	ú		↳	Ě	Ń	˘
4	\$	4	D	T	d	t	ä	ö	Å	↳	↳	đ	ń	˘
5	%	5	E	U	e	u	û	L	ą	Á	+	Ń	ń	§
6	&	6	F	V	f	v	é	í	Ž	Â	Ā	Í	Š	÷
7	'	7	G	W	g	w	ç	Š	ž	Ě	ā	Ī	š	,
8	(8	H	X	h	x	ł	ś	Ę	Ş	↳	ě	Ř	°
9)	9	I	Y	i	y	ë	Ö	ę	↳	↳	↳	Ú	˘
A	*	:	J	Z	j	z	Ő	Ü		↳	↳	↳	ř	˘
B	+	;	K	[k	{	ó	Ť	ž	↳	↳	↳	Ů	ú
C	,	<	L	\	l		í	ť	č	↳	↳	↳	ý	Ř
D	-	=	M]	m	}	Ž	Ł	ş	Ž	=	↳	Ý	ř
E	.	>	N	^	n	˘	Ä	×	«	ž	↳	↳	Ů	ř
F	/	?	O	_	o	△	Ć	č	»	↳	↳	↳	ř	

(4) PC-857

	2	3	4	5	6	7	8	9	A	B	C	D	E	F
0		0	@	P	`	p	Ç	É	á	⋮	↳	°	Ó	-
1	!	1	A	Q	a	q	ü	æ	í	⊞	↳	ª	β	±
2	"	2	B	R	b	r	é	Æ	ó	⊞	↳	Ê	Ô	
3	#	3	C	S	c	s	â	ô	ú		↳	Ě	Ò	¼
4	\$	4	D	T	d	t	ä	ö	ñ	↳	↳	È	ø	¶
5	%	5	E	U	e	u	à	ò	Ñ	Á	+	↳	Õ	§
6	&	6	F	V	f	v	á	ú	Ĝ	Â	ā	Í	μ	÷
7	'	7	G	W	g	w	ç	ù	ğ	À	Ã	Ī		,
8	(8	H	X	h	x	é	İ	ı	©	↳	İ	×	°
9)	9	I	Y	i	y	ë	Ö	®	↳	↳	↳	Ú	˘
A	*	:	J	Z	j	z	è	Ü	↳	↳	↳	↳	Ů	˘
B	+	;	K	[k	{	ĩ	ø	½	↳	↳	↳	Ů	¹
C	,	<	L	\	l		í	£	¼	↳	↳	↳	ı	³
D	-	=	M]	m	}	ı	Ø	ı	c	=	↳	ý	²
E	.	>	N	^	n	˘	Ä	Ş	«	↳	↳	↳	İ	-
F	/	?	O	_	o	△	Å	ş	»	↳	↳	↳	ř	

(5) PC-851

	2	3	4	5	6	7	8	9	A	B	C	D	E	F
0	0	@	P	`	p	Ç	Ì	ï	⋮	└	Т	ζ	-	
1	!	1	A	Q	a	q	ü	ï	⊗	└	Υ	η	±	
2	"	2	B	R	b	r	é	Ó	ó	⊞	└	Φ	θ	υ
3	#	3	C	S	c	s	â	ô	ú		└	X	ι	φ
4	\$	4	D	T	d	t	ä	ö	Ä	└	—	Ψ	κ	χ
5	%	5	E	U	e	u	à	Y	B	K	+	Ω	λ	§
6	&	6	F	V	f	v	À	û	Γ	Λ	Π	α	μ	ψ
7	'	7	G	W	g	w	ç	ù	Δ	M	P	β	ν	,
8	(8	H	X	h	x	ê	Ω	E	N	⊞	γ	ξ	°
9)	9	I	Y	i	y	ë	Ö	Z	⊞	⊞	└	o	¨
A	*	:	J	Z	j	z	è	Ü	H		⊞	└	π	ω
B	+	;	K	[k	{	ï	á	½	⊞	⊞	■	ρ	ü
C	,	<	L	\	l		î	£	Θ	⊞	⊞	■	σ	ü
D	-	=	M]	m	}	É	é	I	Ξ	=	δ	ς	ώ
E	.	>	N	^	n	~	Ä	ñ	<	O	⊞	ε	τ	■
F	/	?	O	_	o	△	‘	í	>	└	Σ	■	'	

(6) PC-855

	2	3	4	5	6	7	8	9	A	B	C	D	E	F
0	0	@	P	`	p	ђ	љ	а	⋮	└	л	Я	-	
1	!	1	A	Q	a	q	Ђ	Љ	А	⊗	└	Л	р	ы
2	"	2	B	R	b	r	ѓ	њ	б	⊞	└	М	Р	Ы
3	#	3	C	S	c	s	Ѓ	Њ	Б		└	М	с	з
4	\$	4	D	T	d	t	ѐ	ћ	ц	└	—	н	С	З
5	%	5	E	U	e	u	Ě	ћ	Ц	x	+	Н	т	ш
6	&	6	F	V	f	v	ě	ќ	д	X	к	о	Т	Ш
7	'	7	G	W	g	w	€	Ќ	Д	и	К	О	у	џ
8	(8	H	X	h	x	s	ŷ	е	И	⊞	п	У	Э
9)	9	I	Y	i	y	S	Ÿ	Е	⊞	⊞	└	ж	ш
A	*	:	J	Z	j	z	i	ц	ф		⊞	└	Ж	Ш
B	+	;	K	[k	{	l	ц	Ф	⊞	⊞	■	в	ч
C	,	<	L	\	l		ï	ю	г	⊞	⊞	■	В	Ч
D	-	=	M]	m	}	İ	Ю	Г	й	=	П	ь	§
E	.	>	N	^	n	~	j	ь	«	Й	⊞	я	Ь	■
F	/	?	O	_	o	△	J	Ђ	»	└	⊞	■	№	

(7) PC-1250

	2	3	4	5	6	7	8	9	A	B	C	D	E	F	
0		0	@	P	`	p	€		°	Ř	Đ	ř	đ		
1	!	1	A	Q	a	q		´	˘	±	Á	Ñ	á	ñ	
2	"	2	B	R	b	r	,	'	˘	˘	Â	Ń	â	ń	
3	#	3	C	S	c	s		“	”	Ł	ł	Ă	Ó	ă	ó
4	\$	4	D	T	d	t	„	”	□	´	Ä	Ô	ä	ô	
5	%	5	E	U	e	u	...	•	Α	μ	Í	Õ	í	ó	
6	&	6	F	V	f	v	†	-		¶	Ć	Ö	ć	ö	
7	'	7	G	W	g	w	‡	—	§	·	Ç	×	ç	÷	
8	(8	H	X	h	x			˙	˙	Č	Ř	č	ř	
9)	9	I	Y	i	y	‰	™	©	ą	É	Ú	é	ù	
A	*	:	J	Z	j	z	Š	š	Ş	ş	Ę	Ú	ę	ú	
B	+	;	K	[k	{	<	>	«	»	Ë	Ú	ë	ú	
C	,	<	L	\	l		Ś	ś	¬	Ł	Ě	Ü	ě	ü	
D	-	=	M]	m	}	Ť	ť	-	˘	Í	Ý	í	ý	
E	.	>	N	^	n	~	Ž	ž	®	ŀ	Î	Ţ	î	ţ	
F	/	?	O	_	o	⌘	Ž	ž	Ž	ž	Đ	ß	đ	·	

(8) PC-1251

	2	3	4	5	6	7	8	9	A	B	C	D	E	F	
0		0	@	P	`	p	Ђ	ђ	°	А	Р	а	р		
1	!	1	A	Q	a	q	Ѓ	ѓ	˘	Ў	±	Б	С	б	с
2	"	2	B	R	b	r	,	'	˘	І	В	Т	в	т	
3	#	3	C	S	c	s	ѓ	“	”	Ј	і	Г	У	г	у
4	\$	4	D	T	d	t	„	”	□	г	Д	Ф	д	ф	
5	%	5	E	U	e	u	...	•	Г	μ	Е	Х	е	х	
6	&	6	F	V	f	v	†	-		¶	Ж	Ц	ж	ц	
7	'	7	G	W	g	w	‡	—	§	·	З	Ч	з	ч	
8	(8	H	X	h	x	€		Ё	ё	И	Ш	и	ш	
9)	9	I	Y	i	y	‰	™	©	№	Й	Щ	й	щ	
A	*	:	J	Z	j	z	Љ	љ	Є	с	К	Ъ	к	ъ	
B	+	;	K	[k	{	<	>	«	»	Л	Ы	л	ы	
C	,	<	L	\	l		Њ	њ	¬	Ј	М	Ь	м	ь	
D	-	=	M]	m	}	Ќ	ќ	-	Š	Н	Э	н	э	
E	.	>	N	^	n	~	Њ	њ	®	š	О	Ю	о	ю	
F	/	?	O	_	o	⌘	Џ	џ	Џ	џ	П	Я	п	я	

(9) PC-1252

	2	3	4	5	6	7	8	9	A	B	C	D	E	F
0		0	@	P	`	p	€		°	À	Ð	à	ð	
1	!	1	A	Q	a	q		'	ı	±	Á	Ñ	á	ñ
2	"	2	B	R	b	r	,	'	ç	²	Â	Ò	â	ò
3	#	3	C	S	c	s	f	"	£	³	Ã	Ó	ã	ó
4	\$	4	D	T	d	t	„	"	¤	'	Ä	Ô	ä	ô
5	%	5	E	U	e	u	...	•	¥	μ	Å	Õ	å	õ
6	&	6	F	V	f	v	†	-		¶	Æ	Ö	æ	ö
7	'	7	G	W	g	w	‡	—	§	·	Ç	×	ç	÷
8	(8	H	X	h	x	^	~	"	,	È	Ø	è	ø
9)	9	I	Y	i	y	‰	™	©	ı	É	Ù	é	ù
A	*	:	J	Z	j	z	Š	š	ª	º	Ê	Ú	ê	ú
B	+	;	K	[k	{	<	>	«	»	Ë	Û	ë	û
C	,	<	L	\	l		Œ	œ	¬	¼	Ì	Ü	ì	ü
D	-	=	M]	m	}			-	½	Í	Ý	í	ý
E	.	>	N	^	n	~	Ž	ž	®	¾	Î	Þ	î	þ
F	/	?	O	_	o	☒		ÿ	¯	¿	Ï	ß	ï	ÿ

(10) PC-1253

	2	3	4	5	6	7	8	9	A	B	C	D	E	F
0		0	@	P	`	p	€		°	ı	Π	Û	π	
1	!	1	A	Q	a	q		'	ˆ	±	Α	Ρ	α	ρ
2	"	2	B	R	b	r	,	'	²	Β		β	ç	
3	#	3	C	S	c	s	f	"	£	³	Γ	Σ	γ	σ
4	\$	4	D	T	d	t	„	"	¤	'	Δ	Τ	δ	τ
5	%	5	E	U	e	u	...	•	¥	μ	Ε	Υ	ε	υ
6	&	6	F	V	f	v	†	-		¶	Ζ	Φ	ζ	φ
7	'	7	G	W	g	w	‡	—	§	·	Η	Χ	η	χ
8	(8	H	X	h	x			"	´	Θ	Ψ	θ	ψ
9)	9	I	Y	i	y	‰	™	©	ˆ	Ι	Ω	ι	ω
A	*	:	J	Z	j	z			ª	ˆ	Κ	İ	κ	ı
B	+	;	K	[k	{	<	>	«	»	Λ	ÿ	λ	ü
C	,	<	L	\	l				¬	ˆ	Ο	Μ	ά	μ
D	-	=	M]	m	}			-	½	Ν	έ	ν	ύ
E	.	>	N	^	n	~			®	ˆ	Υ	Ξ	ή	ξ
F	/	?	O	_	o	☒			—	ˆ	Ω	Ο	ί	ο

(11) PC-1254

	2	3	4	5	6	7	8	9	A	B	C	D	E	F
0	0	@	P	`	p	€		°	À	Ğ	à	ğ		
1	!	1	A	Q	a	q		‘	ı	±	Á	Ñ	á	ñ
2	"	2	B	R	b	r	,	’	c	²	Â	Ò	â	ò
3	#	3	C	S	c	s	f	“	£	³	Ã	Ó	ã	ó
4	\$	4	D	T	d	t	„	”	¤	´	Ä	Ô	ä	ô
5	%	5	E	U	e	u	...	•	¥	μ	Å	Õ	å	õ
6	&	6	F	V	f	v	†	-		¶	Æ	Ö	æ	ö
7	'	7	G	W	g	w	‡	—	§	·	Ç	×	ç	÷
8	(8	H	X	h	x	^	˘	˙	˚	È	Ø	è	ø
9)	9	I	Y	i	y	%	™	©	¹	É	Ù	é	ù
A	*	:	J	Z	j	z	Š	š	ª	º	Ê	Ú	ê	ú
B	+	;	K	[k	{	<	>	«	»	Ë	Û	ë	û
C	,	<	L	\	l		Œ	œ	¬	¼	Ì	Ü	ì	ü
D	-	=	M]	m	}			-	½	Í	ı	í	ı
E	.	>	N	^	n	~			®	¾	Î	Ş	î	ş
F	/	?	O	_	o	☒		ÿ	ˉ	¿	İ	ß	ï	ÿ

(12) PC-1257

	2	3	4	5	6	7	8	9	A	B	C	D	E	F
0	0	@	P	`	p	€		°	Ą	Ś	ą	ś		
1	!	1	A	Q	a	q		‘		±	Į	Ń	į	ń
2	"	2	B	R	b	r	,	’	c	²	Ā	Ņ	ā	ņ
3	#	3	C	S	c	s		“	£	³	Ć	Ó	ć	ó
4	\$	4	D	T	d	t	„	”	¤	´	Ä	Ö	ä	ö
5	%	5	E	U	e	u	...	•		μ	Å	Õ	å	õ
6	&	6	F	V	f	v	†	-		¶	Ę	Ö	ę	ö
7	'	7	G	W	g	w	‡	—	§	·	Ē	×	ē	÷
8	(8	H	X	h	x			Ø	ø	Č	Ů	č	ů
9)	9	I	Y	i	y	%	™	©	¹	É	Ł	é	ł
A	*	:	J	Z	j	z			Ŕ	ř	Ž	Š	ž	š
B	+	;	K	[k	{	<	>	«	»	Ë	Û	ë	û
C	,	<	L	\	l				¬	¼	Ĝ	Ü	ĝ	ü
D	-	=	M]	m	}	˘	˙	-	½	Ķ	Ž	ķ	ž
E	.	>	N	^	n	~	˘	˙	®	¾	Ī	Ž	ī	ž
F	/	?	O	_	o	☒			Æ	æ	Ł	ß	ł	·

(13) LATIN9

	2	3	4	5	6	7	8	9	A	B	C	D	E	F
0		0	@	P	`	p			°	À	Đ	à	đ	
1	!	1	A	Q	a	q			ı	±	Á	Ñ	á	ñ
2	"	2	B	R	b	r			¢	²	Â	Ò	â	ò
3	#	3	C	S	c	s			£	³	Ã	Ó	ã	ó
4	\$	4	D	T	d	t			€	Ž	Ä	Ô	ä	ô
5	%	5	E	U	e	u			¥	μ	Å	Õ	å	õ
6	&	6	F	V	f	v			Š	¶	Æ	Ö	æ	ö
7	'	7	G	W	g	w			§	·	Ç	×	ç	÷
8	(8	H	X	h	x			š	ž	È	Ø	è	ø
9)	9	I	Y	i	y			©	¹	É	Ù	é	ù
A	*	:	J	Z	j	z			ª	º	Ê	Ú	ê	ú
B	+	;	K	[k	{			«	»	Ë	Û	ë	û
C	,	<	L	\	l				¬	œ	Ì	Ü	ì	ü
D	-	=	M]	m	}			-	æ	Í	Ý	í	ý
E	.	>	N	^	n	~			®	ÿ	Î	Þ	î	þ
F	/	?	O	_	o	☒			-	ı	Ï	ß	ï	ÿ

(14) Arabic

	2	3	4	5	6	7	8	9	A	B	C	D	E	F
0		،	ء	ت	ا	ح			ى	ف	.	ء		
1	أ	-	=	ث	ل	ع			ل	ى	لا	ء		
2	أ	.	'	ث	,	ع			ل	ء	لا	ء		
3	أ	/	؟	ج	-	غ			م	ث	لأ	ء		
4		٠	—	ج	ز	ح			م	ث	لأ	ء		
5	!	١	ا	س	ج	غ			ث	0	لأ	ء		
6	"	٢	ا	س	ح	غ			هـ	1	لأ	ء	الله	
7	«	٣	أ	س	ح	ف			+	2	لأ	ء	ن	
8	»	٤	أ	س	ح	ف			هـ	3	لأ	ء		
9	%	٥	آ	ص	ح	ف			هـ	4	لأ	ء		
A	x	٦	آ	ص	ح	ف			و	5	لأ	ء		
B	÷	٧	!	ص	ح	ف			بـ	6	لأ	ء		
C	(٨	ل	د	ض	ق			ي	7	لأ	ء		
D)	٩	بـ	ذ	ط	ك			ي	8	لأ	ء		
E	*	:	بـ	ظ	ك	ك			ة	9	لأ	ء		
F	+	٤	ث	ا	ع				ة	ى	لأ	ء		

12. BAR CODE TABLE

(1) WPC (JAN, EAN, UPC)
ITF, MSI, UCC/EAN128, Industrial 2 of 5

	2	3	4	5	6	7
0		0				
1		1				
2		2				
3		3				
4		4				
5		5				
6		6				
7		7				
8		8				
9		9				
A						
B						
C						
D						
E						
F						

(2) CODE39 (Standard)

	2	3	4	5	6	7
0	SP	0		P		
1		1	A	Q		
2		2	B	R		
3		3	C	S		
4	\$	4	D	T		
5	%	5	E	U		
6		6	F	V		
7		7	G	W		
8		8	H	X		
9		9	I	Y		
A	.		J	Z		
B	+		K			
C			L			
D	-		M			
E	•		N			
F	/		O			

(3) CODE39 (Full ASCII)

[Transfer code]

	2	3	4	5	6	7
0	SP	0	@	P	`	p
1	!	1	A	Q	a	q
2	"	2	B	R	b	r
3	#	3	C	S	c	s
4	\$	4	D	T	d	t
5	%	5	E	U	e	u
6	&	6	F	V	f	v
7	'	7	G	W	g	w
8	(8	H	X	h	x
9)	9	I	Y	i	y
A	*	:	J	Z	j	z
B	+	;	K	[k	{
C	,	<	L	\	l	
D	-	=	M]	m	}
E	.	>	N	^	n	~
F	/	?	O	_	o	△

[Drawing code]

	2	3	4	5	6	7
0	SP	0	%V	P	%W	+P
1	/A	1	A	Q	+A	+Q
2	/B	2	B	R	+B	+R
3	/C	3	C	S	+C	+S
4	/D	4	D	T	+D	+T
5	/E	5	E	U	+E	+U
6	/F	6	F	V	+F	+V
7	/G	7	G	W	+G	+W
8	/H	8	H	X	+H	+X
9	/I	9	I	Y	+I	+Y
A	/J	/Z	J	Z	+J	+Z
B	/K	%F	K	%K	+K	%P
C	/L	%G	L	%L	+L	%Q
D	-	%H	M	%M	+M	%R
E	.	%I	N	%N	+N	%S
F	/O	%J	O	%O	+O	%T



(4) NW-7

	2	3	4	5	6	7
0	SP	0				
1		1	A		a	
2		2	B		b	
3		3	C		c	
4	\$	4	D		d	t
5		5			e	
6		6				
7		7				
8		8				
9		9				
A	*	:				
B	+					
C						
D	-					
E	•				n	
F	/					

(5) CODE93

[Transfer code]

	2	3	4	5	6	7
0	SP	0	@	P	`	p
1	!	1	A	Q	a	q
2	"	2	B	R	b	r
3	#	3	C	S	c	s
4	\$	4	D	T	d	t
5	%	5	E	U	e	u
6	&	6	F	V	f	v
7	'	7	G	W	g	w
8	(8	H	X	h	x
9)	9	I	Y	i	y
A	*	:	J	Z	j	z
B	+	;	K	[k	{
C	,	<	L	\	l	
D	-	=	M]	m	}
E	.	>	N	^	n	~
F	/	?	O	_	o	△

[Drawing code]

	2	3	4	5	6	7
0	SP	0	%V	P	%W	+P
1	/A	1	A	Q	+A	+Q
2	/B	2	B	R	+B	+R
3	/C	3	C	S	+C	+S
4	/D	4	D	T	+D	+T
5	/E	5	E	U	+E	+U
6	/F	6	F	V	+F	+V
7	/G	7	G	W	+G	+W
8	/H	8	H	X	+H	+X
9	/I	9	I	Y	+I	+Y
A	/J	/Z	J	Z	+J	+Z
B	+	%F	K	%K	+K	%P
C	/L	%G	L	%L	+L	%Q
D	-	%H	M	%M	+M	%R
E	.	%I	N	%N	+N	%S
F	/	%J	O	%O	+O	%T



(6) CODE128

[Transfer code]

	-	-	2	3	4	5	6	7
0	NUL	DLE	SP	0	@	P	`	p
1	SOH	DC1	!	1	A	Q	a	q
2	STX	DC2	"	2	B	R	b	r
3	ETX	DC3	#	3	C	S	c	s
4	EOT	DC4	\$	4	D	T	d	t
5	ENQ	NAK	%	5	E	U	e	u
6	ACK	SYN	&	6	F	V	f	v
7	BEL	ETB	'	7	G	W	g	w
8	BS	CAN	(8	H	X	h	x
9	HT	EM)	9	I	Y	i	y
A	LF	SUB	*	:	J	Z	j	z
B	VT	ESC	+	;	K	[k	{
C	FF	FS	,	<	L	\	l	
D	CR	GS	-	=	M]	m	}
E	SO	RS	.	>	N	^	n	~
F	SI	US	/	?	O	_	o	△



[Drawing code]

Value Code Table

① How to transmit control code data:

NUL (00H) → >@ (3EH, 40H)
 SOH (01H) → >A (3EH, 41H)
 STX (02H) → >B (3EH, 42H)
 to
 GS (1DH) → >] (3EH, 5DH)
 RS (1EH) → >^ (3EH, 5EH)
 US (1FH) → >_ (3EH, 5FH)

② How to transmit special codes:

Value
 30 (Character >) → >0
 95 → >1
 96 → >2
 97 → >3
 98 → >4
 99 → >5
 100 → >6
 101 → >7
 102 → >8

③ Designation of start code:

START (CODE A) → >7
 START (CODE B) → >6
 START (CODE C) → >5

Value Code Table

VALUE	CODE A	CODE B	CODE C
0	SP	SP	00
1	!	!	01
2	"	"	02
3	#	#	03
4	\$	\$	04
5	%	%	05
6	&	&	06
7	'	'	07
8	((08
9))	09
10	*	*	10
11	+	+	11
12	,	,	12
13	-	-	13
14	.	.	14
15	/	/	15
16	0	0	16
17	1	1	17
18	2	2	18
19	3	3	19
20	4	4	20
21	5	5	21
22	6	6	22
23	7	7	23
24	8	8	24
25	9	9	25
26	:	:	26
27	;	;	27
28	<	<	28
29	=	=	29
30	>	>	30
31	?	?	31
32	@	@	32
33	A	A	33
34	B	B	34
35	C	C	35

VALUE	CODE A	CODE B	CODE C
36	D	D	36
37	E	E	37
38	F	F	38
39	G	G	39
40	H	H	40
41	I	I	41
42	J	J	42
43	K	K	43
44	L	L	44
45	M	M	45
46	N	N	46
47	O	O	47
48	P	P	48
49	Q	Q	49
50	R	R	50
51	S	S	51
52	T	T	52
53	U	U	53
54	V	V	54
55	W	W	55
56	X	X	56
57	Y	Y	57
58	Z	Z	58
59	[[59
60	\	\	60
61]]	61
62	^	^	62
63	_	_	63
64	NUL	`	64
65	SOH	a	65
66	STX	b	66
67	ETX	c	67
68	EOT	d	68
69	ENQ	e	69
70	ACK	f	70
71	BEL	g	71

VALUE	CODE A	CODE B	CODE C
72	BS	h	72
73	HT	i	73
74	LF	j	74
75	VT	k	75
76	FF	l	76
77	CR	m	77
78	SO	n	78
79	SI	o	79
80	DLE	p	80
81	DC1	q	81
82	DC2	r	82
83	DC3	s	83
84	DC4	t	84
85	NAK	u	85
86	SYN	v	86
87	ETB	w	87
88	CAN	x	88
89	EM	y	89
90	SUB	z	90
91	ESC	{	91
92	FS		92
93	GS	}	93
94	RS	~	94
95	US	DEL	95
96	FNC3	FNC3	96
97	FNC2	FNC2	97
98	SHIFT	SHIFT	98
99	CODE C	CODE C	99
100	CODE B	FNC4	CODE B
101	FNC4	CODE A	CODE A
102	FNC1	FNC1	FNC1

103	START CODE A
104	START CODE B
105	START CODE C

(7) Data Matrix

The code to be used is designated using the format ID.

Format ID	Code	Details
1	Numerics	0 to 9 space
2	Letters	A to Z space
3	Alphanumerics, symbols	0 to 9 A to Z space . , - /
4	Alphanumerics	0 to 9 A to Z space
5	ASCII (7-bit)	00H to 7FH
6	ISO (8-bit)	00H to FFH (Kanji)

[Transfer Code]

	0	1	2	3	4	5	6	7	8	9	A	B	C	D	E	F
0	NUL	DLE	SP	0	@	P	`	p								
1	SOH	DC1	!	1	A	Q	a	q								
2	STX	DC2	"	2	B	R	b	r								
3	ETX	DC3	#	3	C	S	c	s								
4	EOT	DC4	\$	4	D	T	d	t								
5	ENQ	NAK	%	5	E	U	e	u								
6	ACK	SYN	&	6	F	V	f	v								
7	BEL	ETB	'	7	G	W	g	w								
8	BS	CAN	(8	H	X	h	x								
9	HT	EM)	9	I	Y	i	y								
A	LF	SUB	*	:	J	Z	j	z								
B	VT	ESC	+	;	K	[k	{								
C	FF	FS	,	<	L	\	l									
D	CR	GS	-	=	M]	m	}								
E	SO	RS	.	>	N	^	n	~								
F	SI	US	/	?	O	_	o	△								

① How to send control code data

NUL (00H) → >@ (3EH, 40H)
 SOH (01H) → >A (3EH, 41H)
 STX (02H) → >B (3EH, 42H)
 to
 GS (1DH) → >] (3EH, 5DH)
 RS (1EH) → >^ (3EH, 5EH)
 US (1FH) → >_ (3EH, 5FH)

② How to send a special code

> (3EH) → >0 (3EH, 30H)

③ How to send a Kanji code

Shift JIS

JIS hexadecimal

(For details, refer to the section for the Bar Code Data Command.)

(8) PDF417

The following modes are automatically selected according to the code used.

Mode	Code	Details
EXC mode	Alphanumerics, symbol	0 to 9 A to Z a to z space ! " # \$ % & ' () * + , - . / : ; < = > ? @ [\] ^ _ ` { } ~ △ CR HT
Binary/ASCII Plus mode	Binary International Character Set	00H to FFH (Kanji)
Numeric Compaction mode	Numerics	0 to 9

[Transfer Code]

	0	1	2	3	4	5	6	7	8	9	A	B	C	D	E	F
0	NUL	DLE	SP	0	@	P	`	p								
1	SOH	DC1	!	1	A	Q	a	q								
2	STX	DC2	"	2	B	R	b	r								
3	ETX	DC3	#	3	C	S	c	s								
4	EOT	DC4	\$	4	D	T	d	t								
5	ENQ	NAK	%	5	E	U	e	u								
6	ACK	SYN	&	6	F	V	f	v								
7	BEL	ETB	'	7	G	W	g	w								
8	BS	CAN	(8	H	X	h	x								
9	HT	EM)	9	I	Y	i	y								
A	LF	SUB	*	:	J	Z	j	z								
B	VT	ESC	+	;	K	[k	{								
C	FF	FS	,	<	L	\	l									
D	CR	GS	-	=	M]	m	}								
E	SO	RS	.	>	N	^	n	~								
F	SI	US	/	?	O	_	o	△								

① How to send control code data

NUL (00H) → >@ (3EH, 40H)
 SOH (01H) → >A (3EH, 41H)
 STX (02H) → >B (3EH, 42H)
 to
 GS (1DH) → >] (3EH, 5DH)
 RS (1EH) → >^ (3EH, 5EH)
 US (1FH) → >_ (3EH, 5FH)

② How to send a special code

> (3EH) → >0 (3EH, 30H)

③ How to send a Kanji code

Shift JIS

JIS hexadecimal

(For details, refer to the section for the Bar Code Data Command.)

(9) MicroPDF417

The following modes are automatically selected according to the code used.

Mode	Details
Upper case letters, space	A to Z, space
Binary International Character Set	00H to FFH (Kanji)
Numerics	0 to 9

[Transfer Code]

	0	1	2	3	4	5	6	7	8	9	A	B	C	D	E	F
0	NUL	DLE	SP	0	@	P	`	p								
1	SOH	DC1	!	1	A	Q	a	q								
2	STX	DC2	"	2	B	R	b	r								
3	ETX	DC3	#	3	C	S	c	s								
4	EOT	DC4	\$	4	D	T	d	t								
5	ENQ	NAK	%	5	E	U	e	u								
6	ACK	SYN	&	6	F	V	f	v								
7	BEL	ETB	'	7	G	W	g	w								
8	BS	CAN	(8	H	X	h	x								
9	HT	EM)	9	I	Y	i	y								
A	LF	SUB	*	:	J	Z	j	z								
B	VT	ESC	+	;	K	[k	{								
C	FF	FS	,	<	L	\	l									
D	CR	GS	-	=	M]	m	}								
E	SO	RS	.	>	N	^	n	~								
F	SI	US	/	?	O	_	o	△								

① How to send control code data

NUL (00H) → >@ (3EH, 40H)
 SOH (01H) → >A (3EH, 41H)
 STX (02H) → >B (3EH, 42H)
 to
 GS (1DH) → >] (3EH, 5DH)
 RS (1EH) → >^ (3EH, 5EH)
 US (1FH) → >_ (3EH, 5FH)

② How to send a special code

> (3EH) → >0 (3EH, 30H)

③ How to send a Kanji code

Shift JIS

JIS hexadecimal

(For details, refer to the section for the Bar Code Data Command.)

(10) QR code

When manual mode is selected in the Format Command

- Numeric mode, alphanumeric and symbol mode, Kanji mode

Mode selection	Data to be printed
----------------	--------------------

- Binary mode

Mode selection	No. of data strings (4 digits)	Data to be printed
----------------	-----------------------------------	--------------------

- Mixed mode

Data	“,” (comma)	Data	“,” (comma)	Data
------	-------------	------	-------------	------

The QR code can handle all codes including alphanumerics, symbols, and Kanji. However, since the data compression rate varies according to codes, the code to be used should be designated by selecting the mode.

Mode	Code	Details
N	Numerals	0 to 9
A	Alphanumerics, symbols	A to Z 0 to 9 space \$ % * + - . / :
B	Binary (8-bit)	00H to FFH
K	Kanji	Shift JIS, JIS hexadecimal

If mixed mode is selected, up to 200 modes can be selected in a QR code.

When the automatic mode is selected in the Format Command for a QR code:

Data to be printed

[Transfer code for QR code]

	0	1	2	3	4	5	6	7	8	9	A	B	C	D	E	F
0	NUL	DLE	SP	0	@	P	`	p								
1	SOH	DC1	!	1	A	Q	a	q								
2	STX	DC2	”	2	B	R	b	r								
3	ETX	DC3	#	3	C	S	c	s								
4	EOT	DC4	\$	4	D	T	d	t								
5	ENQ	NAK	%	5	E	U	e	u								
6	ACK	SYN	&	6	F	V	f	v								
7	BEL	ETB	'	7	G	W	g	w								
8	BS	CAN	(8	H	X	h	x								
9	HT	EM)	9	I	Y	i	y								
A	LF	SUB	*	:	J	Z	j	z								
B	VT	ESC	+	;	K	[k	{								
C	FF	FS	,	<	L	\	l									
D	CR	GS	-	=	M]	m	}								
E	SO	RS	•	>	N	^	n	~								
F	SI	US	/	?	O	_	o	DEL								

* The shaded parts are Japanese. They are omitted here.

① How to send control code data

NUL (00H) → >@ (3EH, 40H)
 SOH (01H) → >A (3EH, 41H)
 STX (02H) → >B (3EH, 42H)
 to
 GS (1DH) → >] (3EH, 5DH)
 RS (1EH) → >^ (3EH, 5EH)
 US (1FH) → >_ (3EH, 5FH)

② How to send a special code

> (3EH) → >0 (3EH, 30H)

③ How to send a Kanji code

Shift JIS
 JIS hexadecimal
 (For details, refer to the section for the Bar Code Data Command.)

Examples of data designation for QR code

① Alphanumeric mode: ABC123

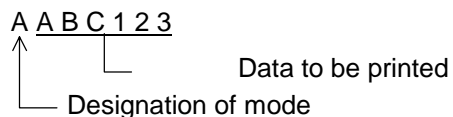

② Binary mode: 01H, 03H, 05H

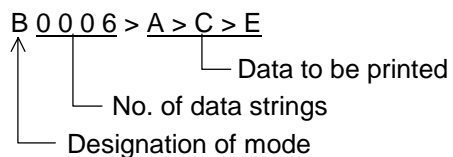

③ Mixed mode

Numeric mode : 123456
 Kanji mode : Kanji data
 Binary mode : a ア i イ u ウ e エ o オ
 Alphanumeric and symbol mode : ABC

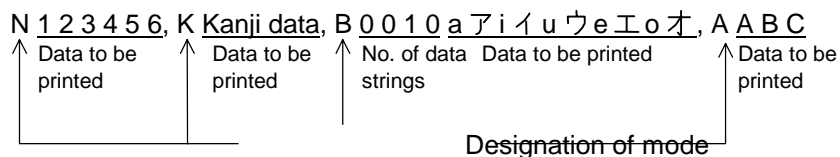

④ Automatic mode

When the same data as ③ above is designated in automatic mode:

1 2 3 4 5 6 Kanji data a ア i イ u ウ e エ o オ A B C
 Data to be printed

(11) Postal code

Customer bar code

	2	3	4	5	6	7
0		0		P		
1		1	A	Q		
2		2	B	R		
3		3	C	S		
4		4	D	T		
5		5	E	U		
6		6	F	V		
7		7	G	W		
8		8	H	X		
9		9	I	Y		
A			J	Z		
B			K			
C			L			
D	-		M			
E			N			
F			O			

POSTNET

	2	3	4	5	6	7
0		0				
1		1				
2		2				
3		3				
4		4				
5		5				
6		6				
7		7				
8		8				
9		9				
A						
B						
C						
D						
E						
F						

RM4SCC

	2	3	4	5	6	7
0		0		P		
1		1	A	Q		
2		2	B	R		
3		3	C	S		
4		4	D	T		
5		5	E	U		
6		6	F	V		
7		7	G	W		
8	(8	H	X		
9)	9	I	Y		
A			J	Z		
B			K			
C			L			
D			M			
E			N			
F			O			

KIX CODE

	2	3	4	5	6	7
0		0		P		p
1		1	A	Q	a	q
2		2	B	R	b	r
3		3	C	S	c	s
4		4	D	T	d	t
5		5	E	U	e	u
6		6	F	V	f	v
7		7	G	W	g	w
8		8	H	X	h	x
9		9	I	Y	i	y
A			J	Z	j	z
B			K		k	
C			L		l	
D			M		m	
E			N		n	
F			O		o	

* (“(” or “)”) can be designated only as a start/stop code.
 These should not be entered in data.
 If these are entered between data, no bar code is drawn.

(12) MaxiCode

Symbol Character Value		Code Set A		Code Set B		Code Set C		Code Set D		Code Set E	
Decimal	Binary	Character	Decimal	Character	Decimal	Character	Decimal	Character	Decimal	Character	Decimal
0	000000	CR	13	'	96	À	192	à	224	NUL	0
1	000001	A	65	a	97	Á	193	á	225	SOH	1
2	000010	B	66	b	98	Â	194	â	226	STX	2
3	000011	C	67	c	99	Ã	195	ã	227	ETX	3
4	000100	D	68	d	100	Ä	196	ä	228	EOT	4
5	000101	E	69	e	101	Å	197	å	229	ENQ	5
6	000110	F	70	f	102	Æ	198	æ	230	ACK	6
7	000111	G	71	g	103	Ç	199	ç	231	BEL	7
8	001000	H	72	h	104	È	200	è	232	BS	8
9	001001	I	73	i	105	É	201	é	233	HT	9
10	001010	J	74	j	106	Ê	202	ê	234	LF	10
11	001011	K	75	k	107	Ë	203	ë	235	VT	11
12	001100	L	76	l	108	Ì	204	ì	236	FF	12
13	001101	M	77	m	109	Í	205	í	237	CR	13
14	001110	N	78	n	110	Î	206	î	238	SO	14
15	001111	O	79	o	111	Ï	207	ï	239	SI	15
16	010000	P	80	p	112	Ð	208	ð	240	DLE	16
17	010001	Q	81	q	113	Ñ	209	ñ	241	DC1	17
18	010010	R	82	r	114	Ò	210	ò	242	DC2	18
19	010011	S	83	s	115	Ó	211	ó	243	DC3	19
20	010100	T	84	t	116	Ô	212	ô	244	DC4	20
21	010101	U	85	u	117	Õ	213	õ	245	NAK	21
22	010110	V	86	v	118	Ö	214	ö	246	SYN	22
23	010111	W	87	w	119	×	215	÷	247	ETB	23
24	011000	X	88	x	120	Ø	216	ø	248	CAN	24
25	011001	Y	89	y	121	Ù	217	ù	249	EM	25
26	011010	Z	90	z	122	Ú	218	ú	250	SUB	26
27	011011	[EC]		[EC]		[EC]		[EC]		[EC]	
28	011100	FS	28	FS	28	FS	28	FS	28	[Pad]	
29	011101	GS	29	GS	29	GS	29	GS	29	[Pad]	
30	011110	RS	30	RS	30	RS	30	RS	30	ESC	27
31	011111	[NS]		[NS]		[NS]		[NS]		[NS]	
32	100000	Space	32	(123	Û	219	û	251	FS	28
33	100001	[Pad])	125	Ü	220	ü	252	GS	29
34	100010	"	34	~	126	Ý	221	ý	253	RS	30
35	100011	#	35	DEL	127	Þ	222	þ	254	US	31
36	100100	\$	36	; :	59	ß	223	ÿ	255	{C159}	159
37	100101	%	37	<	60	à	170	ÿ	161	NBSP	160
38	100110	&	38	=	61	ı	172	ı	168	¢	162
39	100111	'	39	>	62	±	177	«	171	£	163
40	101000	(40	? :	63	²	178	¬	175	¤	164
41	101001)	41	[91	³	179	°	176	¥	165
42	101010	"	42	\	92	´	181	´	180		166
43	101011	+	43]	93	¹	185	•	183	§	167
44	101100	,	44	^	94	º	186	•	184	©	169
45	101101	-	45	_	95	¼	188	»	187	SHY	173
46	101110	.	46	Space	32	½	189	¿	191	®	174
47	101111	/	47	,	44	¾	190	{C138}	138	¶	182
48	110000	0	48	.	46	{C128}	128	{C139}	139	{C149}	149
49	110001	1	49	/	47	{C129}	129	{C140}	140	{C150}	150
50	110010	2	50	:	58	{C130}	130	{C141}	141	{C151}	151
51	110011	3	51	@	64	{C131}	131	{C142}	142	{C152}	152
52	110100	4	52	!	33	{C132}	132	{C143}	143	{C153}	153
53	110101	5	53		124	{C133}	133	{C144}	144	{C154}	154
54	110110	6	54	[Pad]		{C134}	134	{C145}	145	{C155}	155
55	110111	7	55	[2 Shift A]		{C135}	135	{C146}	146	{C156}	156
56	111000	8	56	[3 Shift A]		{C136}	136	{C147}	147	{C157}	157
57	111001	9	57	[Pad]		{C137}	137	{C148}	148	{C158}	158
58	111010	:	58	[Latch A]		[Latch A]		[Latch A]		[Latch A]	
59	111011	[Shift B]		[Shift A]		Space	32	Space	32	Space	32
60	111100	[Shift C]		[Shift C]		[Lock In C]		[Shift C]		[Shift C]	
61	111101	[Shift D]		[Shift D]		[Shift D]		[Lock In D]		[Shift D]	
62	111110	[Shift E]		[Shift E]		[Shift E]		[Shift E]		[Lock In E]	
63	111111	[Latch B]		[Latch A]		[Latch B]		[Latch B]		[Latch B]	

① How to send control code data

SOH (01H)	→	>A	(3EH, 41H)
STX (02H)	→	>B	(3EH, 42H)
to			
GS (1DH)	→	>]	(3EH, 5DH)
RS (1EH)	→	>^	(3EH, 5EH)
US (1FH)	→	>_	(3EH, 5FH)

② How to send a special code

>	(3EH)	→	>0	(3EH, 30H)
---	-------	---	----	------------

③ How to send a Kanji code

Shift JIS

JIS hexadecimal

(For details, refer to the section for the Bar Code Data Command.)

NOTE: "NUL" code in the table cannot be used, however, it can be designated.
If it is designated, data following "NUL" code is not printed.

(13) CP code

[Transfer Code]

	0	1	2	3	4	5	6	7	8	9	A	B	C	D	E	F
0	NUL	DLE	SP	0	@	P	`	p								
1	SOH	DC1	!	1	A	Q	a	q								
2	STX	DC2	"	2	B	R	b	r								
3	ETX	DC3	#	3	C	S	c	s								
4	EOT	DC4	\$	4	D	T	d	t								
5	ENQ	NAK	%	5	E	U	e	u								
6	ACK	SYN	&	6	F	V	f	v								
7	BEL	ETB	'	7	G	W	g	w								
8	BS	CAN	(8	H	X	h	x								
9	HT	EM)	9	I	Y	i	y								
A	LF	SUB	*	:	J	Z	j	z								
B	VT	ESC	+	;	K	[k	{								
C	FF	FS	,	<	L	\	l									
D	CR	GS	-	=	M]	m	}								
E	SO	RS	.	>	N	^	n	~								
F	SI	US	/	?	O	_	o	△								

① How to send control code data

NUL (00H) → >@ (3EH, 40H)
 SOH (01H) → >A (3EH, 41H)
 STX (02H) → >B (3EH, 42H)
 to
 GS (1DH) → >] (3EH, 5DH)
 RS (1EH) → >^ (3EH, 5EH)
 US (1FH) → >_ (3EH, 5FH)

② How to send a special code

> (3EH) → >0 (3EH, 30H)

③ How to send a Kanji code

Shift JIS

JIS hexadecimal

(For details, refer to the section for the Bar Code Data Command.)

13. DRAWING OF BAR CODE DATA

- : Field to be incremented/decremented
(The absence of a solid line invalidates incrementing/decrementing.)
- : Field subject to printing numerals under bars.

Type of Bar Code: JAN8, EAN8

(1) No affix

No. of Input Digits										
8 digits	Input Data	<table border="1" style="display: inline-table;"> <tr> <td>D₁</td><td>D₂</td><td>D₃</td><td>D₄</td><td>D₅</td><td>D₆</td><td>D₇</td><td>D₈</td> </tr> </table> <div style="text-align: right; margin-right: 50px;"> To be checked as modulus 10 C/D </div>	D ₁	D ₂	D ₃	D ₄	D ₅	D ₆	D ₇	D ₈
	D ₁	D ₂	D ₃	D ₄	D ₅	D ₆	D ₇	D ₈		
Drawing Data	<table border="1" style="display: inline-table;"> <tr> <td>D₁</td><td>D₂</td><td>D₃</td><td>D₄</td><td>D₅</td><td>D₆</td><td>D₇</td><td>D₈</td> </tr> </table>	D ₁	D ₂	D ₃	D ₄	D ₅	D ₆	D ₇	D ₈	
D ₁	D ₂	D ₃	D ₄	D ₅	D ₆	D ₇	D ₈			
Other than 8 digits		Not to be drawn								

(2) Modulus 10 check

No. of Input Digits										
8 digits	Input Data	<table border="1" style="display: inline-table;"> <tr> <td>D₁</td><td>D₂</td><td>D₃</td><td>D₄</td><td>D₅</td><td>D₆</td><td>D₇</td><td>D₈</td> </tr> </table> <div style="text-align: right; margin-right: 50px;"> To be checked as modulus 10 C/D </div>	D ₁	D ₂	D ₃	D ₄	D ₅	D ₆	D ₇	D ₈
	D ₁	D ₂	D ₃	D ₄	D ₅	D ₆	D ₇	D ₈		
Drawing Data	<table border="1" style="display: inline-table;"> <tr> <td>D₁</td><td>D₂</td><td>D₃</td><td>D₄</td><td>D₅</td><td>D₆</td><td>D₇</td><td>D₈</td> </tr> </table>	D ₁	D ₂	D ₃	D ₄	D ₅	D ₆	D ₇	D ₈	
D ₁	D ₂	D ₃	D ₄	D ₅	D ₆	D ₇	D ₈			
Other than 8 digits		Not to be drawn								

(3) Auto affix of modulus 10

No. of Input Digits									
7 digits	Input Data	<table border="1" style="display: inline-table;"> <tr> <td>D₁</td><td>D₂</td><td>D₃</td><td>D₄</td><td>D₅</td><td>D₆</td><td>D₇</td> </tr> </table>	D ₁	D ₂	D ₃	D ₄	D ₅	D ₆	D ₇
	D ₁	D ₂	D ₃	D ₄	D ₅	D ₆	D ₇		
Drawing Data	<table border="1" style="display: inline-table;"> <tr> <td>D₁</td><td>D₂</td><td>D₃</td><td>D₄</td><td>D₅</td><td>D₆</td><td>D₇</td><td>C/D</td> </tr> </table> <div style="text-align: right; margin-right: 50px;"> Affix a modulus 10 C/D. </div>	D ₁	D ₂	D ₃	D ₄	D ₅	D ₆	D ₇	C/D
D ₁	D ₂	D ₃	D ₄	D ₅	D ₆	D ₇	C/D		
Other than 7 digits		Not to be drawn							

Type of Bar Code: JAN13, EAN13

(1) No affix

No. of Input Digits		
13 digits	Input Data	D ₁ D ₂ D ₃ D ₄ D ₅ D ₆ D ₇ D ₈ D ₉ D ₁₀ D ₁₁ D ₁₂ D ₁₃
	Drawing Data	D ₂ D ₃ D ₄ D ₅ D ₆ D ₇ D ₈ D ₉ D ₁₀ D ₁₁ D ₁₂ D ₁₃
Other than 13 digits		Not to be drawn

(2) Modulus 10 check

No. of Input Digits		
13 digits	Input Data	D ₁ D ₂ D ₃ D ₄ D ₅ D ₆ D ₇ D ₈ D ₉ D ₁₀ D ₁₁ D ₁₂ D ₁₃
	Drawing Data	D ₂ D ₃ D ₄ D ₅ D ₆ D ₇ D ₈ D ₉ D ₁₀ D ₁₁ D ₁₂ D ₁₃
Other than 13 digits		Not to be drawn

(3) Auto affix of modulus 10

No. of Input Digits		
12 digits	Input Data	D ₁ D ₂ D ₃ D ₄ D ₅ D ₆ D ₇ D ₈ D ₉ D ₁₀ D ₁₁ D ₁₂
	Drawing Data	D ₂ D ₃ D ₄ D ₅ D ₆ D ₇ D ₈ D ₉ D ₁₀ D ₁₁ D ₁₂ C/D
Other than 12 digits		Not to be drawn

(4) Auto affix of modulus 10 + price C/D 4 digits

No. of Input Digits		
11 digits	Input Data	D ₁ D ₂ D ₃ D ₄ D ₅ D ₆ D ₇ D ₈ D ₉ D ₁₀ D ₁₁
	Drawing Data	D ₂ D ₃ D ₄ D ₅ D ₆ D ₇ P/CD D ₈ D ₉ D ₁₀ D ₁₁ C/D
Other than 11 digits		Not to be drawn

(5) Auto affix of modulus 10 + price C/D 5 digits

No. of Input Digits		
11 digits	Input Data	D ₁ D ₂ D ₃ D ₄ D ₅ D ₆ D ₇ D ₈ D ₉ D ₁₀ D ₁₁
	Drawing Data	D ₂ D ₃ D ₄ D ₅ D ₆ P/CD D ₇ D ₈ D ₉ D ₁₀ D ₁₁ C/D
Other than 11 digits		Not to be drawn

Type of Bar Code: UPC-A

(1) No affix

No. of Input Digits														
12 digits	Input Data	<table border="1"> <tr> <td>D₁</td><td>D₂</td><td>D₃</td><td>D₄</td><td>D₅</td><td>D₆</td><td>D₇</td><td>D₈</td><td>D₉</td><td>D₁₀</td><td>D₁₁</td><td>D₁₂</td> </tr> </table> <p style="text-align: center;">To be checked as modulus 10 C/D</p>	D ₁	D ₂	D ₃	D ₄	D ₅	D ₆	D ₇	D ₈	D ₉	D ₁₀	D ₁₁	D ₁₂
	D ₁	D ₂	D ₃	D ₄	D ₅	D ₆	D ₇	D ₈	D ₉	D ₁₀	D ₁₁	D ₁₂		
Drawing Data	<table border="1"> <tr> <td>D₁</td><td>D₂</td><td>D₃</td><td>D₄</td><td>D₅</td><td>D₆</td><td>D₇</td><td>D₈</td><td>D₉</td><td>D₁₀</td><td>D₁₁</td><td>D₁₂</td> </tr> </table>	D ₁	D ₂	D ₃	D ₄	D ₅	D ₆	D ₇	D ₈	D ₉	D ₁₀	D ₁₁	D ₁₂	
D ₁	D ₂	D ₃	D ₄	D ₅	D ₆	D ₇	D ₈	D ₉	D ₁₀	D ₁₁	D ₁₂			
Other than 12 digits		Not to be drawn												

(2) Modulus 10 check

No. of Input Digits														
12 digits	Input Data	<table border="1"> <tr> <td>D₁</td><td>D₂</td><td>D₃</td><td>D₄</td><td>D₅</td><td>D₆</td><td>D₇</td><td>D₈</td><td>D₉</td><td>D₁₀</td><td>D₁₁</td><td>D₁₂</td> </tr> </table> <p style="text-align: center;">To be checked as modulus 10 C/D</p>	D ₁	D ₂	D ₃	D ₄	D ₅	D ₆	D ₇	D ₈	D ₉	D ₁₀	D ₁₁	D ₁₂
	D ₁	D ₂	D ₃	D ₄	D ₅	D ₆	D ₇	D ₈	D ₉	D ₁₀	D ₁₁	D ₁₂		
Drawing Data	<table border="1"> <tr> <td>D₁</td><td>D₂</td><td>D₃</td><td>D₄</td><td>D₅</td><td>D₆</td><td>D₇</td><td>D₈</td><td>D₉</td><td>D₁₀</td><td>D₁₁</td><td>D₁₂</td> </tr> </table>	D ₁	D ₂	D ₃	D ₄	D ₅	D ₆	D ₇	D ₈	D ₉	D ₁₀	D ₁₁	D ₁₂	
D ₁	D ₂	D ₃	D ₄	D ₅	D ₆	D ₇	D ₈	D ₉	D ₁₀	D ₁₁	D ₁₂			
Other than 12 digits		Not to be drawn												

(3) Auto affix of modulus 10

No. of Input Digits													
11 digits	Input Data	<table border="1"> <tr> <td>D₁</td><td>D₂</td><td>D₃</td><td>D₄</td><td>D₅</td><td>D₆</td><td>D₇</td><td>D₈</td><td>D₉</td><td>D₁₀</td><td>D₁₁</td> </tr> </table>	D ₁	D ₂	D ₃	D ₄	D ₅	D ₆	D ₇	D ₈	D ₉	D ₁₀	D ₁₁
	D ₁	D ₂	D ₃	D ₄	D ₅	D ₆	D ₇	D ₈	D ₉	D ₁₀	D ₁₁		
Drawing Data	<table border="1"> <tr> <td>D₁</td><td>D₂</td><td>D₃</td><td>D₄</td><td>D₅</td><td>D₆</td><td>D₇</td><td>D₈</td><td>D₉</td><td>D₁₀</td><td>D₁₁</td><td>C/D</td> </tr> </table> <p style="text-align: right;">Affix a modulus 10 C/D.</p>	D ₁	D ₂	D ₃	D ₄	D ₅	D ₆	D ₇	D ₈	D ₉	D ₁₀	D ₁₁	C/D
D ₁	D ₂	D ₃	D ₄	D ₅	D ₆	D ₇	D ₈	D ₉	D ₁₀	D ₁₁	C/D		
Other than 11 digits		Not to be drawn											

(4) Auto affix of modulus 10 + price C/D 4 digits

No. of Input Digits													
10 digits	Input Data	<table border="1"> <tr> <td>D₁</td><td>D₂</td><td>D₃</td><td>D₄</td><td>D₅</td><td>D₆</td><td>D₇</td><td>D₈</td><td>D₉</td><td>D₁₀</td> </tr> </table>	D ₁	D ₂	D ₃	D ₄	D ₅	D ₆	D ₇	D ₈	D ₉	D ₁₀	
	D ₁	D ₂	D ₃	D ₄	D ₅	D ₆	D ₇	D ₈	D ₉	D ₁₀			
Drawing Data	<table border="1"> <tr> <td>D₁</td><td>D₂</td><td>D₃</td><td>D₄</td><td>D₅</td><td>D₆</td><td>P/CD</td><td>D₇</td><td>D₈</td><td>D₉</td><td>D₁₀</td><td>C/D</td> </tr> </table> <p style="text-align: right;">Affix price C/D 4 digits. Affix a modulus 10 C/D.</p>	D ₁	D ₂	D ₃	D ₄	D ₅	D ₆	P/CD	D ₇	D ₈	D ₉	D ₁₀	C/D
D ₁	D ₂	D ₃	D ₄	D ₅	D ₆	P/CD	D ₇	D ₈	D ₉	D ₁₀	C/D		
Other than 10 digits		Not to be drawn											

(5) Auto affix of modulus 10 + price C/D 5 digits

No. of Input Digits													
10 digits	Input Data	<table border="1"> <tr> <td>D₁</td><td>D₂</td><td>D₃</td><td>D₄</td><td>D₅</td><td>D₆</td><td>D₇</td><td>D₈</td><td>D₉</td><td>D₁₀</td> </tr> </table>	D ₁	D ₂	D ₃	D ₄	D ₅	D ₆	D ₇	D ₈	D ₉	D ₁₀	
	D ₁	D ₂	D ₃	D ₄	D ₅	D ₆	D ₇	D ₈	D ₉	D ₁₀			
Drawing Data	<table border="1"> <tr> <td>D₁</td><td>D₂</td><td>D₃</td><td>D₄</td><td>D₅</td><td>D₆</td><td>P/CD</td><td>D₇</td><td>D₈</td><td>D₉</td><td>D₁₀</td><td>C/D</td> </tr> </table> <p style="text-align: right;">Affix price C/D 5 digits. Affix a modulus 10 C/D.</p>	D ₁	D ₂	D ₃	D ₄	D ₅	D ₆	P/CD	D ₇	D ₈	D ₉	D ₁₀	C/D
D ₁	D ₂	D ₃	D ₄	D ₅	D ₆	P/CD	D ₇	D ₈	D ₉	D ₁₀	C/D		
Other than 10 digits		Not to be drawn											

Type of Bar Code: UPC-E

(1) No affix

No. of Input Digits									
7 digits	Input Data	<table border="1" style="display: inline-table; vertical-align: middle;"> <tr> <td>D₁</td><td>D₂</td><td>D₃</td><td>D₄</td><td>D₅</td><td>D₆</td><td>D₇</td> </tr> </table> └─ To be checked as modulus 10 C/D	D ₁	D ₂	D ₃	D ₄	D ₅	D ₆	D ₇
	D ₁	D ₂	D ₃	D ₄	D ₅	D ₆	D ₇		
Drawing Data	<table border="1" style="display: inline-table; vertical-align: middle;"> <tr> <td>0</td><td>D₁</td><td>D₂</td><td>D₃</td><td>D₄</td><td>D₅</td><td>D₆</td><td>D₇</td> </tr> </table>	0	D ₁	D ₂	D ₃	D ₄	D ₅	D ₆	D ₇
0	D ₁	D ₂	D ₃	D ₄	D ₅	D ₆	D ₇		
Other than 7 digits		Not to be drawn							

(2) Modulus 10 check

No. of Input Digits									
7 digits	Input Data	<table border="1" style="display: inline-table; vertical-align: middle;"> <tr> <td>D₁</td><td>D₂</td><td>D₃</td><td>D₄</td><td>D₅</td><td>D₆</td><td>D₇</td> </tr> </table> └─ To be checked as modulus 10 C/D	D ₁	D ₂	D ₃	D ₄	D ₅	D ₆	D ₇
	D ₁	D ₂	D ₃	D ₄	D ₅	D ₆	D ₇		
Drawing Data	<table border="1" style="display: inline-table; vertical-align: middle;"> <tr> <td>0</td><td>D₁</td><td>D₂</td><td>D₃</td><td>D₄</td><td>D₅</td><td>D₆</td><td>D₇</td> </tr> </table>	0	D ₁	D ₂	D ₃	D ₄	D ₅	D ₆	D ₇
0	D ₁	D ₂	D ₃	D ₄	D ₅	D ₆	D ₇		
Other than 7 digits		Not to be drawn							

(3) Auto affix of modulus 10

No. of Input Digits									
6 digits	Input Data	<table border="1" style="display: inline-table; vertical-align: middle;"> <tr> <td>D₁</td><td>D₂</td><td>D₃</td><td>D₄</td><td>D₅</td><td>D₆</td> </tr> </table> Calculate and reflect modulus 10 in the bar code.	D ₁	D ₂	D ₃	D ₄	D ₅	D ₆	
	D ₁	D ₂	D ₃	D ₄	D ₅	D ₆			
Drawing Data	<table border="1" style="display: inline-table; vertical-align: middle;"> <tr> <td>0</td><td>D₁</td><td>D₂</td><td>D₃</td><td>D₄</td><td>D₅</td><td>D₆</td><td>C/D</td> </tr> </table>	0	D ₁	D ₂	D ₃	D ₄	D ₅	D ₆	C/D
0	D ₁	D ₂	D ₃	D ₄	D ₅	D ₆	C/D		
Other than 6 digits		Not to be drawn							

Type of Bar Code: JAN8 +2 digits, EAN8 + 2 digits

(1) No affix

No. of Input Digits												
10 digits	Input Data	<table border="1"> <tr> <td>D₁</td><td>D₂</td><td>D₃</td><td>D₄</td><td>D₅</td><td>D₆</td><td>D₇</td><td>D₈</td><td>D₉</td><td>D₁₀</td> </tr> </table> <p style="text-align: right;">└─ To be checked as modulus 10 C/D</p>	D ₁	D ₂	D ₃	D ₄	D ₅	D ₆	D ₇	D ₈	D ₉	D ₁₀
	D ₁	D ₂	D ₃	D ₄	D ₅	D ₆	D ₇	D ₈	D ₉	D ₁₀		
Drawing Data	<table border="1"> <tr> <td>D₁</td><td>D₂</td><td>D₃</td><td>D₄</td><td>D₅</td><td>D₆</td><td>D₇</td><td>D₈</td> <td>D₉</td><td>D₁₀</td> </tr> </table>	D ₁	D ₂	D ₃	D ₄	D ₅	D ₆	D ₇	D ₈	D ₉	D ₁₀	
D ₁	D ₂	D ₃	D ₄	D ₅	D ₆	D ₇	D ₈	D ₉	D ₁₀			
Other than 10 digits		Not to be drawn										

(2) Modulus 10 check

No. of Input Digits												
10 digits	Input Data	<table border="1"> <tr> <td>D₁</td><td>D₂</td><td>D₃</td><td>D₄</td><td>D₅</td><td>D₆</td><td>D₇</td><td>D₈</td><td>D₉</td><td>D₁₀</td> </tr> </table> <p style="text-align: right;">└─ To be checked as modulus 10 C/D</p>	D ₁	D ₂	D ₃	D ₄	D ₅	D ₆	D ₇	D ₈	D ₉	D ₁₀
	D ₁	D ₂	D ₃	D ₄	D ₅	D ₆	D ₇	D ₈	D ₉	D ₁₀		
Drawing Data	<table border="1"> <tr> <td>D₁</td><td>D₂</td><td>D₃</td><td>D₄</td><td>D₅</td><td>D₆</td><td>D₇</td><td>D₈</td> <td>D₉</td><td>D₁₀</td> </tr> </table>	D ₁	D ₂	D ₃	D ₄	D ₅	D ₆	D ₇	D ₈	D ₉	D ₁₀	
D ₁	D ₂	D ₃	D ₄	D ₅	D ₆	D ₇	D ₈	D ₉	D ₁₀			
Other than 10 digits		Not to be drawn										

(3) Auto affix of modulus 10

No. of Input Digits											
9 digits	Input Data	<table border="1"> <tr> <td>D₁</td><td>D₂</td><td>D₃</td><td>D₄</td><td>D₅</td><td>D₆</td><td>D₇</td><td>D₈</td><td>D₉</td> </tr> </table>	D ₁	D ₂	D ₃	D ₄	D ₅	D ₆	D ₇	D ₈	D ₉
	D ₁	D ₂	D ₃	D ₄	D ₅	D ₆	D ₇	D ₈	D ₉		
Drawing Data	<table border="1"> <tr> <td>D₁</td><td>D₂</td><td>D₃</td><td>D₄</td><td>D₅</td><td>D₆</td><td>D₇</td><td>C/D</td> <td>D₈</td><td>D₉</td> </tr> </table> <p style="text-align: right;">└─ Affix a modulus 10 C/D.</p>	D ₁	D ₂	D ₃	D ₄	D ₅	D ₆	D ₇	C/D	D ₈	D ₉
D ₁	D ₂	D ₃	D ₄	D ₅	D ₆	D ₇	C/D	D ₈	D ₉		
Other than 9 digits		Not to be drawn									

Type of Bar Code: JAN8 +5 digits, EAN8 + 5 digits

(1) No affix

No. of Input Digits															
13 digits	Input Data	<table border="1"> <tr> <td>D₁</td><td>D₂</td><td>D₃</td><td>D₄</td><td>D₅</td><td>D₆</td><td>D₇</td><td>D₈</td><td>D₉</td><td>D₁₀</td><td>D₁₁</td><td>D₁₂</td><td>D₁₃</td> </tr> </table> <p style="text-align: right;">└─ To be checked as modulus 10 C/D</p>	D ₁	D ₂	D ₃	D ₄	D ₅	D ₆	D ₇	D ₈	D ₉	D ₁₀	D ₁₁	D ₁₂	D ₁₃
	D ₁	D ₂	D ₃	D ₄	D ₅	D ₆	D ₇	D ₈	D ₉	D ₁₀	D ₁₁	D ₁₂	D ₁₃		
Drawing Data	<table border="1"> <tr> <td>D₁</td><td>D₂</td><td>D₃</td><td>D₄</td><td>D₅</td><td>D₆</td><td>D₇</td><td>D₈</td> <td>D₉</td><td>D₁₀</td><td>D₁₁</td><td>D₁₂</td><td>D₁₃</td> </tr> </table>	D ₁	D ₂	D ₃	D ₄	D ₅	D ₆	D ₇	D ₈	D ₉	D ₁₀	D ₁₁	D ₁₂	D ₁₃	
D ₁	D ₂	D ₃	D ₄	D ₅	D ₆	D ₇	D ₈	D ₉	D ₁₀	D ₁₁	D ₁₂	D ₁₃			
Other than 13 digits		Not to be drawn													

(2) Modulus 10 check

No. of Input Digits															
13 digits	Input Data	<table border="1"> <tr> <td>D₁</td><td>D₂</td><td>D₃</td><td>D₄</td><td>D₅</td><td>D₆</td><td>D₇</td><td>D₈</td><td>D₉</td><td>D₁₀</td><td>D₁₁</td><td>D₁₂</td><td>D₁₃</td> </tr> </table> <p style="text-align: right;">└─ To be checked as modulus 10 C/D</p>	D ₁	D ₂	D ₃	D ₄	D ₅	D ₆	D ₇	D ₈	D ₉	D ₁₀	D ₁₁	D ₁₂	D ₁₃
	D ₁	D ₂	D ₃	D ₄	D ₅	D ₆	D ₇	D ₈	D ₉	D ₁₀	D ₁₁	D ₁₂	D ₁₃		
Drawing Data	<table border="1"> <tr> <td>D₁</td><td>D₂</td><td>D₃</td><td>D₄</td><td>D₅</td><td>D₆</td><td>D₇</td><td>D₈</td> <td>D₉</td><td>D₁₀</td><td>D₁₁</td><td>D₁₂</td><td>D₁₃</td> </tr> </table>	D ₁	D ₂	D ₃	D ₄	D ₅	D ₆	D ₇	D ₈	D ₉	D ₁₀	D ₁₁	D ₁₂	D ₁₃	
D ₁	D ₂	D ₃	D ₄	D ₅	D ₆	D ₇	D ₈	D ₉	D ₁₀	D ₁₁	D ₁₂	D ₁₃			
Other than 13 digits		Not to be drawn													

(3) Auto affix of modulus 10

No. of Input Digits														
12 digits	Input Data	<table border="1"> <tr> <td>D₁</td><td>D₂</td><td>D₃</td><td>D₄</td><td>D₅</td><td>D₆</td><td>D₇</td><td>D₈</td><td>D₉</td><td>D₁₀</td><td>D₁₁</td><td>D₁₂</td> </tr> </table>	D ₁	D ₂	D ₃	D ₄	D ₅	D ₆	D ₇	D ₈	D ₉	D ₁₀	D ₁₁	D ₁₂
	D ₁	D ₂	D ₃	D ₄	D ₅	D ₆	D ₇	D ₈	D ₉	D ₁₀	D ₁₁	D ₁₂		
Drawing Data	<table border="1"> <tr> <td>D₁</td><td>D₂</td><td>D₃</td><td>D₄</td><td>D₅</td><td>D₆</td><td>D₇</td><td>C/D</td> <td>D₈</td><td>D₉</td><td>D₁₀</td><td>D₁₁</td><td>D₁₂</td> </tr> </table> <p style="text-align: right;">└─ Affix a modulus 10 C/D.</p>	D ₁	D ₂	D ₃	D ₄	D ₅	D ₆	D ₇	C/D	D ₈	D ₉	D ₁₀	D ₁₁	D ₁₂
D ₁	D ₂	D ₃	D ₄	D ₅	D ₆	D ₇	C/D	D ₈	D ₉	D ₁₀	D ₁₁	D ₁₂		
Other than 12 digits		Not to be drawn												

Type of Bar Code: JAN13 +2 digits, EAN13 + 2 digits

(1) No affix

No. of Input Digits		
15 digits	Input Data	D ₁ D ₂ D ₃ D ₄ D ₅ D ₆ D ₇ D ₈ D ₉ D ₁₀ D ₁₁ D ₁₂ D ₁₃ D ₁₄ D ₁₅
	Drawing Data	<div style="border: 1px solid black; padding: 2px; display: inline-block;"> D₂ D₃ D₄ D₅ D₆ D₇ D₈ D₉ D₁₀ D₁₁ D₁₂ D₁₃ </div> D₁₄ D₁₅
Other than 15 digits		Not to be drawn

(2) Modulus 10 check

No. of Input Digits		
15 digits	Input Data	D ₁ D ₂ D ₃ D ₄ D ₅ D ₆ D ₇ D ₈ D ₉ D ₁₀ D ₁₁ D ₁₂ D ₁₃ D ₁₄ D ₁₅
	Drawing Data	<div style="border: 1px solid black; padding: 2px; display: inline-block;"> D₂ D₃ D₄ D₅ D₆ D₇ D₈ D₉ D₁₀ D₁₁ D₁₂ D₁₃ </div> D₁₄ D₁₅
Other than 15 digits		Not to be drawn

(3) Auto affix of modulus 10

No. of Input Digits		
14 digits	Input Data	D ₁ D ₂ D ₃ D ₄ D ₅ D ₆ D ₇ D ₈ D ₉ D ₁₀ D ₁₁ D ₁₂ D ₁₃ D ₁₄
	Drawing Data	<div style="border: 1px solid black; padding: 2px; display: inline-block;"> D₂ D₃ D₄ D₅ D₆ D₇ D₈ D₉ D₁₀ D₁₁ D₁₂ C/D </div> D₁₃ D₁₄
Other than 14 digits		Not to be drawn

(4) Auto affix of modulus 10 + price C/D 4 digits

No. of Input Digits		
13 digits	Input Data	D ₁ D ₂ D ₃ D ₄ D ₅ D ₆ D ₇ D ₈ D ₉ D ₁₀ D ₁₁ D ₁₂ D ₁₃
	Drawing Data	<div style="border: 1px solid black; padding: 2px; display: inline-block;"> D₂ D₃ D₄ D₅ D₆ D₇ P/CD D₈ D₉ D₁₀ D₁₁ C/D </div> D₁₂ D₁₃
Other than 13 digits		Not to be drawn

(5) Auto affix of modulus 10 + price C/D 5 digits

No. of Input Digits		
13 digits	Input Data	D ₁ D ₂ D ₃ D ₄ D ₅ D ₆ D ₇ D ₈ D ₉ D ₁₀ D ₁₁ D ₁₂ D ₁₃
	Drawing Data	<div style="border: 1px solid black; padding: 2px; display: inline-block;"> D₂ D₃ D₄ D₅ D₆ P/CD D₇ D₈ D₉ D₁₀ D₁₁ C/D </div> D₁₂ D₁₃
Other than 13 digits		Not to be drawn

Type of Bar Code: JAN13 +5 digits, EAN13 + 5 digits

(1) No affix

No. of Input Digits		
18 digits	Input Data	D ₁ D ₂ D ₃ D ₄ D ₅ D ₆ D ₇ D ₈ D ₉ D ₁₀ D ₁₁ D ₁₂ D ₁₃ D ₁₄ D ₁₅ D ₁₆ D ₁₇ D ₁₈
	Drawing Data	<div style="border: 1px solid black; padding: 2px; display: inline-block;"> D₂ D₃ D₄ D₅ D₆ D₇ D₈ D₉ D₁₀ D₁₁ D₁₂ D₁₃ </div> D₁₄ D₁₅ D₁₆ D₁₇ D₁₈
Other than 18 digits		Not to be drawn

(2) Modulus 10 check

No. of Input Digits		
18 digits	Input Data	D ₁ D ₂ D ₃ D ₄ D ₅ D ₆ D ₇ D ₈ D ₉ D ₁₀ D ₁₁ D ₁₂ D ₁₃ D ₁₄ D ₁₅ D ₁₆ D ₁₇ D ₁₈
	Drawing Data	<div style="border: 1px solid black; padding: 2px; display: inline-block;"> D₂ D₃ D₄ D₅ D₆ D₇ D₈ D₉ D₁₀ D₁₁ D₁₂ D₁₃ </div> D₁₄ D₁₅ D₁₆ D₁₇ D₁₈
Other than 18 digits		Not to be drawn

(3) Auto affix of modulus 10

No. of Input Digits		
17 digits	Input Data	D ₁ D ₂ D ₃ D ₄ D ₅ D ₆ D ₇ D ₈ D ₉ D ₁₀ D ₁₁ D ₁₂ D ₁₃ D ₁₄ D ₁₅ D ₁₆ D ₁₇
	Drawing Data	<div style="border: 1px solid black; padding: 2px; display: inline-block;"> D₂ D₃ D₄ D₅ D₆ D₇ D₈ D₉ D₁₀ D₁₁ D₁₂ C/D </div> D₁₃ D₁₄ D₁₅ D₁₆ D₁₇
Other than 17 digits		Not to be drawn

(4) Auto affix of modulus 10 + price C/D 4 digits

No. of Input Digits		
16 digits	Input Data	D ₁ D ₂ D ₃ D ₄ D ₅ D ₆ D ₇ D ₈ D ₉ D ₁₀ D ₁₁ D ₁₂ D ₁₃ D ₁₄ D ₁₅ D ₁₆
	Drawing Data	<div style="border: 1px solid black; padding: 2px; display: inline-block;"> D₂ D₃ D₄ D₅ D₆ D₇ P/CD D₈ D₉ D₁₀ D₁₁ C/D </div> D₁₂ D₁₃ D₁₄ D₁₅ D₁₆
Other than 16 digits		Not to be drawn

(5) Auto affix of modulus 10 + price C/D 5 digits

No. of Input Digits		
16 digits	Input Data	D ₁ D ₂ D ₃ D ₄ D ₅ D ₆ D ₇ D ₈ D ₉ D ₁₀ D ₁₁ D ₁₂ D ₁₃ D ₁₄ D ₁₅ D ₁₆
	Drawing Data	<div style="border: 1px solid black; padding: 2px; display: inline-block;"> D₂ D₃ D₄ D₅ D₆ P/CD D₇ D₈ D₉ D₁₀ D₁₁ C/D </div> D₁₂ D₁₃ D₁₄ D₁₅ D₁₆
Other than 16 digits		Not to be drawn

Type of Bar Code: UPC-A + 2 digits

(1) No affix

No. of Input Digits																
14 digits	Input Data	<table border="1"> <tr> <td>D₁</td><td>D₂</td><td>D₃</td><td>D₄</td><td>D₅</td><td>D₆</td><td>D₇</td><td>D₈</td><td>D₉</td><td>D₁₀</td><td>D₁₁</td><td>D₁₂</td><td>D₁₃</td><td>D₁₄</td> </tr> </table> <p style="text-align: center;">To be checked as modulus 10 C/D</p>	D ₁	D ₂	D ₃	D ₄	D ₅	D ₆	D ₇	D ₈	D ₉	D ₁₀	D ₁₁	D ₁₂	D ₁₃	D ₁₄
	D ₁	D ₂	D ₃	D ₄	D ₅	D ₆	D ₇	D ₈	D ₉	D ₁₀	D ₁₁	D ₁₂	D ₁₃	D ₁₄		
Drawing Data	<table border="1"> <tr> <td>D₁</td><td>D₂</td><td>D₃</td><td>D₄</td><td>D₅</td><td>D₆</td><td>D₇</td><td>D₈</td><td>D₉</td><td>D₁₀</td><td>D₁₁</td><td>D₁₂</td> <td>D₁₃</td><td>D₁₄</td> </tr> </table>	D ₁	D ₂	D ₃	D ₄	D ₅	D ₆	D ₇	D ₈	D ₉	D ₁₀	D ₁₁	D ₁₂	D ₁₃	D ₁₄	
D ₁	D ₂	D ₃	D ₄	D ₅	D ₆	D ₇	D ₈	D ₉	D ₁₀	D ₁₁	D ₁₂	D ₁₃	D ₁₄			
Other than 14 digits		Not to be drawn														

(2) Modulus 10 check

No. of Input Digits																
14 digits	Input Data	<table border="1"> <tr> <td>D₁</td><td>D₂</td><td>D₃</td><td>D₄</td><td>D₅</td><td>D₆</td><td>D₇</td><td>D₈</td><td>D₉</td><td>D₁₀</td><td>D₁₁</td><td>D₁₂</td><td>D₁₃</td><td>D₁₄</td> </tr> </table> <p style="text-align: center;">To be checked as modulus 10 C/D</p>	D ₁	D ₂	D ₃	D ₄	D ₅	D ₆	D ₇	D ₈	D ₉	D ₁₀	D ₁₁	D ₁₂	D ₁₃	D ₁₄
	D ₁	D ₂	D ₃	D ₄	D ₅	D ₆	D ₇	D ₈	D ₉	D ₁₀	D ₁₁	D ₁₂	D ₁₃	D ₁₄		
Drawing Data	<table border="1"> <tr> <td>D₁</td><td>D₂</td><td>D₃</td><td>D₄</td><td>D₅</td><td>D₆</td><td>D₇</td><td>D₈</td><td>D₉</td><td>D₁₀</td><td>D₁₁</td><td>D₁₂</td> <td>D₁₃</td><td>D₁₄</td> </tr> </table>	D ₁	D ₂	D ₃	D ₄	D ₅	D ₆	D ₇	D ₈	D ₉	D ₁₀	D ₁₁	D ₁₂	D ₁₃	D ₁₄	
D ₁	D ₂	D ₃	D ₄	D ₅	D ₆	D ₇	D ₈	D ₉	D ₁₀	D ₁₁	D ₁₂	D ₁₃	D ₁₄			
Other than 14 digits		Not to be drawn														

(3) Auto affix of modulus 10

No. of Input Digits															
13 digits	Input Data	<table border="1"> <tr> <td>D₁</td><td>D₂</td><td>D₃</td><td>D₄</td><td>D₅</td><td>D₆</td><td>D₇</td><td>D₈</td><td>D₉</td><td>D₁₀</td><td>D₁₁</td><td>D₁₂</td><td>D₁₃</td> </tr> </table>	D ₁	D ₂	D ₃	D ₄	D ₅	D ₆	D ₇	D ₈	D ₉	D ₁₀	D ₁₁	D ₁₂	D ₁₃
	D ₁	D ₂	D ₃	D ₄	D ₅	D ₆	D ₇	D ₈	D ₉	D ₁₀	D ₁₁	D ₁₂	D ₁₃		
Drawing Data	<table border="1"> <tr> <td>D₁</td><td>D₂</td><td>D₃</td><td>D₄</td><td>D₅</td><td>D₆</td><td>D₇</td><td>D₈</td><td>D₉</td><td>D₁₀</td><td>D₁₁</td><td>C/D</td> <td>D₁₂</td><td>D₁₃</td> </tr> </table> <p style="text-align: right;">Affix a modulus 10 C/D.</p>	D ₁	D ₂	D ₃	D ₄	D ₅	D ₆	D ₇	D ₈	D ₉	D ₁₀	D ₁₁	C/D	D ₁₂	D ₁₃
D ₁	D ₂	D ₃	D ₄	D ₅	D ₆	D ₇	D ₈	D ₉	D ₁₀	D ₁₁	C/D	D ₁₂	D ₁₃		
Other than 13 digits		Not to be drawn													

(4) Auto affix of modulus 10 + price C/D 4 digits

No. of Input Digits															
12 digits	Input Data	<table border="1"> <tr> <td>D₁</td><td>D₂</td><td>D₃</td><td>D₄</td><td>D₅</td><td>D₆</td><td>D₇</td><td>D₈</td><td>D₉</td><td>D₁₀</td><td>D₁₁</td><td>D₁₂</td> </tr> </table>	D ₁	D ₂	D ₃	D ₄	D ₅	D ₆	D ₇	D ₈	D ₉	D ₁₀	D ₁₁	D ₁₂	
	D ₁	D ₂	D ₃	D ₄	D ₅	D ₆	D ₇	D ₈	D ₉	D ₁₀	D ₁₁	D ₁₂			
Drawing Data	<table border="1"> <tr> <td>D₁</td><td>D₂</td><td>D₃</td><td>D₄</td><td>D₅</td><td>D₆</td><td>P/CD</td><td>D₇</td><td>D₈</td><td>D₉</td><td>D₁₀</td><td>C/D</td> <td>D₁₁</td><td>D₁₂</td> </tr> </table> <p style="text-align: right;">Affix price C/D 4 digits. Affix a modulus 10 C/D.</p>	D ₁	D ₂	D ₃	D ₄	D ₅	D ₆	P/CD	D ₇	D ₈	D ₉	D ₁₀	C/D	D ₁₁	D ₁₂
D ₁	D ₂	D ₃	D ₄	D ₅	D ₆	P/CD	D ₇	D ₈	D ₉	D ₁₀	C/D	D ₁₁	D ₁₂		
Other than 12 digits		Not to be drawn													

(5) Auto affix of modulus 10 + price C/D 5 digits

No. of Input Digits															
12 digits	Input Data	<table border="1"> <tr> <td>D₁</td><td>D₂</td><td>D₃</td><td>D₄</td><td>D₅</td><td>D₆</td><td>D₇</td><td>D₈</td><td>D₉</td><td>D₁₀</td><td>D₁₁</td><td>D₁₂</td> </tr> </table>	D ₁	D ₂	D ₃	D ₄	D ₅	D ₆	D ₇	D ₈	D ₉	D ₁₀	D ₁₁	D ₁₂	
	D ₁	D ₂	D ₃	D ₄	D ₅	D ₆	D ₇	D ₈	D ₉	D ₁₀	D ₁₁	D ₁₂			
Drawing Data	<table border="1"> <tr> <td>D₁</td><td>D₂</td><td>D₃</td><td>D₄</td><td>D₅</td><td>P/CD</td><td>D₆</td><td>D₇</td><td>D₈</td><td>D₉</td><td>D₁₀</td><td>C/D</td> <td>D₁₁</td><td>D₁₂</td> </tr> </table> <p style="text-align: right;">Affix price C/D 5 digits. Affix a modulus 10 C/D.</p>	D ₁	D ₂	D ₃	D ₄	D ₅	P/CD	D ₆	D ₇	D ₈	D ₉	D ₁₀	C/D	D ₁₁	D ₁₂
D ₁	D ₂	D ₃	D ₄	D ₅	P/CD	D ₆	D ₇	D ₈	D ₉	D ₁₀	C/D	D ₁₁	D ₁₂		
Other than 12 digits		Not to be drawn													

Type of Bar Code: UPC-A + 5 digits

(1) No affix

No. of Input Digits		
17 digits	Input Data	D ₁ D ₂ D ₃ D ₄ D ₅ D ₆ D ₇ D ₈ D ₉ D ₁₀ D ₁₁ D ₁₂ D ₁₃ D ₁₄ D ₁₅ D ₁₆ D ₁₇ To be checked as modulus 10 C/D
	Drawing Data	D ₁ D ₂ D ₃ D ₄ D ₅ D ₆ D ₇ D ₈ D ₉ D ₁₀ D ₁₁ D ₁₂ D ₁₃ D ₁₄ D ₁₅ D ₁₆ D ₁₇
Other than 17 digits		Not to be drawn

(2) Modulus 10 check

No. of Input Digits		
17 digits	Input Data	D ₁ D ₂ D ₃ D ₄ D ₅ D ₆ D ₇ D ₈ D ₉ D ₁₀ D ₁₁ D ₁₂ D ₁₃ D ₁₄ D ₁₅ D ₁₆ D ₁₇ To be checked as modulus 10 C/D
	Drawing Data	D ₁ D ₂ D ₃ D ₄ D ₅ D ₆ D ₇ D ₈ D ₉ D ₁₀ D ₁₁ D ₁₂ D ₁₃ D ₁₄ D ₁₅ D ₁₆ D ₁₇
Other than 17 digits		Not to be drawn

(3) Auto affix of modulus 10

No. of Input Digits		
16 digits	Input Data	D ₁ D ₂ D ₃ D ₄ D ₅ D ₆ D ₇ D ₈ D ₉ D ₁₀ D ₁₁ D ₁₂ D ₁₃ D ₁₄ D ₁₅ D ₁₆
	Drawing Data	D ₁ D ₂ D ₃ D ₄ D ₅ D ₆ D ₇ D ₈ D ₉ D ₁₀ D ₁₁ C/D D ₁₂ D ₁₃ D ₁₄ D ₁₅ D ₁₆ Affix a modulus 10 C/D.
Other than 16 digits		Not to be drawn

(4) Auto affix of modulus 10 + price C/D 4 digits

No. of Input Digits		
15 digits	Input Data	D ₁ D ₂ D ₃ D ₄ D ₅ D ₆ D ₇ D ₈ D ₉ D ₁₀ D ₁₁ D ₁₂ D ₁₃ D ₁₄ D ₁₅
	Drawing Data	D ₁ D ₂ D ₃ D ₄ D ₅ D ₆ P/CD D ₇ D ₈ D ₉ D ₁₀ C/D D ₁₁ D ₁₂ D ₁₃ D ₁₄ D ₁₅ Affix price C/D 4 digits. Affix a modulus 10 C/D.
Other than 15 digits		Not to be drawn

(5) Auto affix of modulus 10 + price C/D 5 digits

No. of Input Digits		
15 digits	Input Data	D ₁ D ₂ D ₃ D ₄ D ₅ D ₆ D ₇ D ₈ D ₉ D ₁₀ D ₁₁ D ₁₂ D ₁₃ D ₁₄ D ₁₅
	Drawing Data	D ₁ D ₂ D ₃ D ₄ D ₅ P/CD D ₆ D ₇ D ₈ D ₉ D ₁₀ C/D D ₁₁ D ₁₂ D ₁₃ D ₁₄ D ₁₅ Affix price C/D 5 digits. Affix a modulus 10 C/D.
Other than 15 digits		Not to be drawn

Type of Bar Code: UPC-E + 2 digits

(1) No affix

No. of Input Digits											
9 digits	Input Data	<table border="1" style="display: inline-table; vertical-align: middle;"> <tr> <td>D₁</td><td>D₂</td><td>D₃</td><td>D₄</td><td>D₅</td><td>D₆</td><td>D₇</td><td>D₈</td><td>D₉</td> </tr> </table> <div style="margin-left: 150px;">└─ To be checked as modulus 10 C/D</div>	D ₁	D ₂	D ₃	D ₄	D ₅	D ₆	D ₇	D ₈	D ₉
	D ₁	D ₂	D ₃	D ₄	D ₅	D ₆	D ₇	D ₈	D ₉		
Drawing Data	<table border="1" style="display: inline-table; vertical-align: middle;"> <tr> <td>0</td><td>D₁</td><td>D₂</td><td>D₃</td><td>D₄</td><td>D₅</td><td>D₆</td><td>D₇</td><td>D₈</td><td>D₉</td> </tr> </table>	0	D ₁	D ₂	D ₃	D ₄	D ₅	D ₆	D ₇	D ₈	D ₉
0	D ₁	D ₂	D ₃	D ₄	D ₅	D ₆	D ₇	D ₈	D ₉		
Other than 9 digits		Not to be drawn									

(2) Modulus 10 check

No. of Input Digits											
9 digits	Input Data	<table border="1" style="display: inline-table; vertical-align: middle;"> <tr> <td>D₁</td><td>D₂</td><td>D₃</td><td>D₄</td><td>D₅</td><td>D₆</td><td>D₇</td><td>D₈</td><td>D₉</td> </tr> </table> <div style="margin-left: 150px;">└─ To be checked as modulus 10 C/D</div>	D ₁	D ₂	D ₃	D ₄	D ₅	D ₆	D ₇	D ₈	D ₉
	D ₁	D ₂	D ₃	D ₄	D ₅	D ₆	D ₇	D ₈	D ₉		
Drawing Data	<table border="1" style="display: inline-table; vertical-align: middle;"> <tr> <td>0</td><td>D₁</td><td>D₂</td><td>D₃</td><td>D₄</td><td>D₅</td><td>D₆</td><td>D₇</td><td>D₈</td><td>D₉</td> </tr> </table>	0	D ₁	D ₂	D ₃	D ₄	D ₅	D ₆	D ₇	D ₈	D ₉
0	D ₁	D ₂	D ₃	D ₄	D ₅	D ₆	D ₇	D ₈	D ₉		
Other than 9 digits		Not to be drawn									

(3) Auto affix of modulus 10

No. of Input Digits											
8 digits	Input Data	<table border="1" style="display: inline-table; vertical-align: middle;"> <tr> <td>D₁</td><td>D₂</td><td>D₃</td><td>D₄</td><td>D₅</td><td>D₆</td><td>D₇</td><td>D₈</td> </tr> </table> <div style="margin-left: 100px;">Calculate and reflect modulus 10 C/D in the bar code.</div>	D ₁	D ₂	D ₃	D ₄	D ₅	D ₆	D ₇	D ₈	
	D ₁	D ₂	D ₃	D ₄	D ₅	D ₆	D ₇	D ₈			
Drawing Data	<table border="1" style="display: inline-table; vertical-align: middle;"> <tr> <td>0</td><td>D₁</td><td>D₂</td><td>D₃</td><td>D₄</td><td>D₅</td><td>D₆</td><td>C/D</td><td>D₇</td><td>D₈</td> </tr> </table>	0	D ₁	D ₂	D ₃	D ₄	D ₅	D ₆	C/D	D ₇	D ₈
0	D ₁	D ₂	D ₃	D ₄	D ₅	D ₆	C/D	D ₇	D ₈		
Other than 8 digits		Not to be drawn									

Type of Bar Code: UPC-E + 5 digits

(1) No affix

No. of Input Digits														
12 digits	Input Data	<table border="1" style="display: inline-table; border-collapse: collapse;"> <tr> <td>D₁</td><td>D₂</td><td>D₃</td><td>D₄</td><td>D₅</td><td>D₆</td><td>D₇</td><td>D₈</td><td>D₉</td><td>D₁₀</td><td>D₁₁</td><td>D₁₂</td> </tr> </table> To be checked as modulus 10 C/D	D ₁	D ₂	D ₃	D ₄	D ₅	D ₆	D ₇	D ₈	D ₉	D ₁₀	D ₁₁	D ₁₂
	D ₁	D ₂	D ₃	D ₄	D ₅	D ₆	D ₇	D ₈	D ₉	D ₁₀	D ₁₁	D ₁₂		
Drawing Data	<table border="1" style="display: inline-table; border-collapse: collapse;"> <tr> <td>0</td><td>D₁</td><td>D₂</td><td>D₃</td><td>D₄</td><td>D₅</td><td>D₆</td><td>D₇</td><td>D₈</td><td>D₉</td><td>D₁₀</td><td>D₁₁</td><td>D₁₂</td> </tr> </table>	0	D ₁	D ₂	D ₃	D ₄	D ₅	D ₆	D ₇	D ₈	D ₉	D ₁₀	D ₁₁	D ₁₂
0	D ₁	D ₂	D ₃	D ₄	D ₅	D ₆	D ₇	D ₈	D ₉	D ₁₀	D ₁₁	D ₁₂		
Other than 12 digits		Not to be drawn												

(2) Modulus 10 check

No. of Input Digits														
12 digits	Input Data	<table border="1" style="display: inline-table; border-collapse: collapse;"> <tr> <td>D₁</td><td>D₂</td><td>D₃</td><td>D₄</td><td>D₅</td><td>D₆</td><td>D₇</td><td>D₈</td><td>D₉</td><td>D₁₀</td><td>D₁₁</td><td>D₁₂</td> </tr> </table> To be checked as modulus 10 C/D	D ₁	D ₂	D ₃	D ₄	D ₅	D ₆	D ₇	D ₈	D ₉	D ₁₀	D ₁₁	D ₁₂
	D ₁	D ₂	D ₃	D ₄	D ₅	D ₆	D ₇	D ₈	D ₉	D ₁₀	D ₁₁	D ₁₂		
Drawing Data	<table border="1" style="display: inline-table; border-collapse: collapse;"> <tr> <td>0</td><td>D₁</td><td>D₂</td><td>D₃</td><td>D₄</td><td>D₅</td><td>D₆</td><td>D₇</td><td>D₈</td><td>D₉</td><td>D₁₀</td><td>D₁₁</td><td>D₁₂</td> </tr> </table>	0	D ₁	D ₂	D ₃	D ₄	D ₅	D ₆	D ₇	D ₈	D ₉	D ₁₀	D ₁₁	D ₁₂
0	D ₁	D ₂	D ₃	D ₄	D ₅	D ₆	D ₇	D ₈	D ₉	D ₁₀	D ₁₁	D ₁₂		
Other than 12 digits		Not to be drawn												

(3) Auto affix of modulus 10

No. of Input Digits														
11 digits	Input Data	<table border="1" style="display: inline-table; border-collapse: collapse;"> <tr> <td>D₁</td><td>D₂</td><td>D₃</td><td>D₄</td><td>D₅</td><td>D₆</td><td>D₇</td><td>D₈</td><td>D₉</td><td>D₁₀</td><td>D₁₁</td> </tr> </table> Calculate and reflect modulus 10 C/D in the bar code.	D ₁	D ₂	D ₃	D ₄	D ₅	D ₆	D ₇	D ₈	D ₉	D ₁₀	D ₁₁	
	D ₁	D ₂	D ₃	D ₄	D ₅	D ₆	D ₇	D ₈	D ₉	D ₁₀	D ₁₁			
Drawing Data	<table border="1" style="display: inline-table; border-collapse: collapse;"> <tr> <td>0</td><td>D₁</td><td>D₂</td><td>D₃</td><td>D₄</td><td>D₅</td><td>D₆</td><td>C/D</td><td>D₇</td><td>D₈</td><td>D₉</td><td>D₁₀</td><td>D₁₁</td> </tr> </table>	0	D ₁	D ₂	D ₃	D ₄	D ₅	D ₆	C/D	D ₇	D ₈	D ₉	D ₁₀	D ₁₁
0	D ₁	D ₂	D ₃	D ₄	D ₅	D ₆	C/D	D ₇	D ₈	D ₉	D ₁₀	D ₁₁		
Other than 11 digits		Not to be drawn												

Type of Bar Code: MSI

(1) No affix

No. of Input Digits		
Max. 15 digits	Input Data	D ₁ D ₂ D ₃ D ₄ D ₅ D ₆ D ₇ D ₈ D ₉ ----- Not recognized as a check digit.
	Drawing Data	D ₁ D ₂ D ₃ D ₄ D ₅ D ₆ D ₇ D ₈ D ₉ ----- -----
16 digits or more		Not to be drawn

(2) IBM modulus 10 check

No. of Input Digits		
Min. 2 digits Max. 15 digits (including C/D)	Input Data	D ₁ D ₂ D ₃ D ₄ D ₅ D ₆ D ₇ D ₈ D ₉ D ₁₀ ----- To be checked IBM as modulus 10
	Drawing Data	D ₁ D ₂ D ₃ D ₄ D ₅ D ₆ D ₇ D ₈ D ₉ D ₁₀ ----- -----
1 digit 16 digits or more		Not to be drawn

(3) Auto affix of IBM modulus 10

No. of Input Digits		
Max. 14 digits	Input Data	D ₁ D ₂ D ₃ D ₄ D ₅ D ₆ D ₇ D ₈ D ₉ ----- -----
	Drawing Data	D ₁ D ₂ D ₃ D ₄ D ₅ D ₆ D ₇ D ₆ D ₉ C/D ----- ----- Affix IBM modulus 10.
15 digits or more		Not to be drawn

(4) IBM modulus 10 + Auto affix of IBM modulus 10

No. of Input Digits		
Max. 13 digits	Input Data	D ₁ D ₂ D ₃ D ₄ D ₅ D ₆ D ₇ D ₈ D ₉ ----- -----
	Drawing Data	D ₁ D ₂ D ₃ D ₄ D ₅ D ₆ D ₇ D ₆ D ₉ C/D ₁ C/D ₂ ----- ----- Affix IBM modulus 10. Affix IBM modulus 10.
14 digits or more		Not to be drawn

(5) IBM modulus 11 + Auto affix of IBM modulus 10

No. of Input Digits		
Max. 13 digits	Input Data	D ₁ D ₂ D ₃ D ₄ D ₅ D ₆ D ₇ D ₈ D ₉ ----- -----
	Drawing Data	D ₁ D ₂ D ₃ D ₄ D ₅ D ₆ D ₇ D ₆ D ₉ C/D ₁ C/D ₂ ----- ----- Affix IBM modulus 10. Affix IBM modulus 11.
14 digits or more		Not to be drawn

Type of Bar Code: Interleaved 2 of 5

(1) No affix

No. of Input Digits		
Max. 126 digits	Input Data	D ₁ D ₂ D ₃ D ₄ D ₅ D ₆ D ₇ D ₈ D ₉ ↙ Not recognized as a check digit.
	Drawing Data	0 <u>D₁ D₂ D₃ D₄ D₅ D₆ D₇ D₈ D₉</u>
127 digits or more		Not to be drawn

(2) Modulus 10 check

No. of Input Digits		
Min. 2 digits Max. 126 digits (including C/D)	Input Data	D ₁ D ₂ D ₃ D ₄ D ₅ D ₆ D ₇ D ₈ D ₉ ↙ To be checked as modulus 10 C/D
	Drawing Data	0 <u>D₁ D₂ D₃ D₄ D₅ D₆ D₇ D₈ D₉</u>
1 digit 127 digits or more		Not to be drawn

(3) Auto affix of modulus 10

No. of Input Digits		
Max. 125 digits	Input Data	D ₁ D ₂ D ₃ D ₄ D ₅ D ₆ D ₇ D ₈ D ₉
	Drawing Data	<u>D₁ D₂ D₃ D₄ D₅ D₆ D₇ D₈ D₉ C/D</u> ↙ Affix a modulus 10 C/D.
126 digits or more		Not to be drawn

(4) Auto affix of DBP modulus 10

No. of Input Digits		
Max. 125 digits	Input Data	D ₁ D ₂ D ₃ D ₄ D ₅ D ₆ D ₇ D ₈ D ₉
	Drawing Data	<u>D₁ D₂ D₃ D₄ D₅ D₆ D₇ D₈ D₉ C/D</u> ↙ Affix a DBP modulus 10.
126 digits or more		Not to be drawn

Type of Bar Code: Industrial 2 of 5

(1) No affix

No. of Input Digits											
Max. 126 digits	Input Data	<table border="1" style="display: inline-table; border-collapse: collapse;"> <tr> <td>D₁</td><td>D₂</td><td>D₃</td><td>D₄</td><td>D₅</td><td>D₆</td><td>D₇</td><td>D₈</td><td>D₉</td> </tr> </table>	D ₁	D ₂	D ₃	D ₄	D ₅	D ₆	D ₇	D ₈	D ₉
	D ₁	D ₂	D ₃	D ₄	D ₅	D ₆	D ₇	D ₈	D ₉		
Drawing Data	<p style="text-align: right;">└ Not recognized as a check digit.</p> <hr style="border-top: 1px dashed black;"/> <table border="1" style="display: inline-table; border-collapse: collapse;"> <tr> <td>0</td><td>D₁</td><td>D₂</td><td>D₃</td><td>D₄</td><td>D₅</td><td>D₆</td><td>D₇</td><td>D₈</td><td>D₉</td> </tr> </table>	0	D ₁	D ₂	D ₃	D ₄	D ₅	D ₆	D ₇	D ₈	D ₉
0	D ₁	D ₂	D ₃	D ₄	D ₅	D ₆	D ₇	D ₈	D ₉		
127 digits or more		Not to be drawn									

(2) Modulus check character check

No. of Input Digits											
Min. 2 digits Max. 126 digits (including C/D)	Input Data	<table border="1" style="display: inline-table; border-collapse: collapse;"> <tr> <td>D₁</td><td>D₂</td><td>D₃</td><td>D₄</td><td>D₅</td><td>D₆</td><td>D₇</td><td>D₈</td><td>D₉</td> </tr> </table>	D ₁	D ₂	D ₃	D ₄	D ₅	D ₆	D ₇	D ₈	D ₉
	D ₁	D ₂	D ₃	D ₄	D ₅	D ₆	D ₇	D ₈	D ₉		
Drawing Data	<p style="text-align: right;">└ To be checked as a modulus check character</p> <hr style="border-top: 1px dashed black;"/> <table border="1" style="display: inline-table; border-collapse: collapse;"> <tr> <td>0</td><td>D₁</td><td>D₂</td><td>D₃</td><td>D₄</td><td>D₅</td><td>D₆</td><td>D₇</td><td>D₈</td><td>D₉</td> </tr> </table>	0	D ₁	D ₂	D ₃	D ₄	D ₅	D ₆	D ₇	D ₈	D ₉
0	D ₁	D ₂	D ₃	D ₄	D ₅	D ₆	D ₇	D ₈	D ₉		
1 digit 127 digits or more		Not to be drawn									

(3) Auto affix of modulus check character

No. of Input Digits											
Max. 125 digits	Input Data	<table border="1" style="display: inline-table; border-collapse: collapse;"> <tr> <td>D₁</td><td>D₂</td><td>D₃</td><td>D₄</td><td>D₅</td><td>D₆</td><td>D₇</td><td>D₈</td><td>D₉</td> </tr> </table>	D ₁	D ₂	D ₃	D ₄	D ₅	D ₆	D ₇	D ₈	D ₉
	D ₁	D ₂	D ₃	D ₄	D ₅	D ₆	D ₇	D ₈	D ₉		
Drawing Data	<table border="1" style="display: inline-table; border-collapse: collapse;"> <tr> <td>D₁</td><td>D₂</td><td>D₃</td><td>D₄</td><td>D₅</td><td>D₆</td><td>D₇</td><td>D₈</td><td>D₉</td><td>C/D</td> </tr> </table> <p style="text-align: right;">└ Affix a modulus check character.</p>	D ₁	D ₂	D ₃	D ₄	D ₅	D ₆	D ₇	D ₈	D ₉	C/D
D ₁	D ₂	D ₃	D ₄	D ₅	D ₆	D ₇	D ₈	D ₉	C/D		
126 digits or more		Not to be drawn									

Type of Bar Code: CODE39 (Standard)

(1) No affix

No. of Input Digits																								
Max. 123 digits	Input Data	<table border="1"> <tr> <td>St</td><td>D₁</td><td>D₂</td><td>D₃</td><td>D₄</td><td>D₅</td><td>D₆</td><td>D₇</td><td>D₈</td><td>D₉</td><td>Sp</td> </tr> <tr> <td colspan="9">Start code</td> <td colspan="2">Stop code</td> </tr> </table> <p>Not recognized as a check digit.</p>	St	D ₁	D ₂	D ₃	D ₄	D ₅	D ₆	D ₇	D ₈	D ₉	Sp	Start code									Stop code	
	St	D ₁	D ₂	D ₃	D ₄	D ₅	D ₆	D ₇	D ₈	D ₉	Sp													
Start code									Stop code															
Drawing Data	<table border="1"> <tr> <td>St</td><td>D₁</td><td>D₂</td><td>D₃</td><td>D₄</td><td>D₅</td><td>D₆</td><td>D₇</td><td>D₈</td><td>D₉</td><td>Sp</td> </tr> </table>	St	D ₁	D ₂	D ₃	D ₄	D ₅	D ₆	D ₇	D ₈	D ₉	Sp												
St	D ₁	D ₂	D ₃	D ₄	D ₅	D ₆	D ₇	D ₈	D ₉	Sp														
124 digits or more		Not to be drawn																						

(2) Modulus 43 check

No. of Input Digits																								
Min. 2 digits Max. 123 digits (including C/D)	Input Data	<table border="1"> <tr> <td>St</td><td>D₁</td><td>D₂</td><td>D₃</td><td>D₄</td><td>D₅</td><td>D₆</td><td>D₇</td><td>D₈</td><td>D₉</td><td>Sp</td> </tr> <tr> <td colspan="9">Start code</td> <td colspan="2">Stop code</td> </tr> </table> <p>To be checked as modulus 43 C/D</p>	St	D ₁	D ₂	D ₃	D ₄	D ₅	D ₆	D ₇	D ₈	D ₉	Sp	Start code									Stop code	
	St	D ₁	D ₂	D ₃	D ₄	D ₅	D ₆	D ₇	D ₈	D ₉	Sp													
Start code									Stop code															
Drawing Data	<table border="1"> <tr> <td>St</td><td>D₁</td><td>D₂</td><td>D₃</td><td>D₄</td><td>D₅</td><td>D₆</td><td>D₇</td><td>D₈</td><td>D₉</td><td>Sp</td> </tr> </table>	St	D ₁	D ₂	D ₃	D ₄	D ₅	D ₆	D ₇	D ₈	D ₉	Sp												
St	D ₁	D ₂	D ₃	D ₄	D ₅	D ₆	D ₇	D ₈	D ₉	Sp														
1 digit 124 digits or more		Not to be drawn																						

(3) Auto affix of modulus 43

No. of Input Digits																								
Max. 122 digits	Input Data	<table border="1"> <tr> <td>St</td><td>D₁</td><td>D₂</td><td>D₃</td><td>D₄</td><td>D₅</td><td>D₆</td><td>D₇</td><td>D₈</td><td>D₉</td><td>Sp</td> </tr> <tr> <td colspan="9">Start code</td> <td colspan="2">Stop code</td> </tr> </table>	St	D ₁	D ₂	D ₃	D ₄	D ₅	D ₆	D ₇	D ₈	D ₉	Sp	Start code									Stop code	
	St	D ₁	D ₂	D ₃	D ₄	D ₅	D ₆	D ₇	D ₈	D ₉	Sp													
Start code									Stop code															
Drawing Data	<table border="1"> <tr> <td>St</td><td>D₁</td><td>D₂</td><td>D₃</td><td>D₄</td><td>D₅</td><td>D₆</td><td>D₇</td><td>D₈</td><td>D₉</td><td>C/D</td><td>Sp</td> </tr> </table> <p>Affix a modulus 43 C/D.</p>	St	D ₁	D ₂	D ₃	D ₄	D ₅	D ₆	D ₇	D ₈	D ₉	C/D	Sp											
St	D ₁	D ₂	D ₃	D ₄	D ₅	D ₆	D ₇	D ₈	D ₉	C/D	Sp													
123 digits or more		Not to be drawn																						

Type of Bar Code: CODE39 (Full ASCII)

(1) No affix

No. of Input Digits																																			
Max. 60 digits	Input Data	<table border="1"> <tr> <td>St</td><td>D₁</td><td>D₂</td><td>D₃</td><td>D₄</td><td>D₅</td><td>D₆</td><td>D₇</td><td>D₈</td><td>D₉</td><td>Sp</td> </tr> <tr> <td colspan="10">Start code</td> <td>Stop code</td> </tr> <tr> <td colspan="11">Not recognized as a check digit.</td> </tr> </table>	St	D ₁	D ₂	D ₃	D ₄	D ₅	D ₆	D ₇	D ₈	D ₉	Sp	Start code										Stop code	Not recognized as a check digit.										
	St	D ₁	D ₂	D ₃	D ₄	D ₅	D ₆	D ₇	D ₈	D ₉	Sp																								
Start code										Stop code																									
Not recognized as a check digit.																																			
Drawing Data	<table border="1"> <tr> <td>St</td><td>D₁</td><td>D₂</td><td>D₃</td><td>D₄</td><td>D₅</td><td>D₆</td><td>D₇</td><td>D₈</td><td>D₉</td><td>Sp</td> </tr> <tr> <td colspan="11">_____</td> </tr> </table>	St	D ₁	D ₂	D ₃	D ₄	D ₅	D ₆	D ₇	D ₈	D ₉	Sp	_____																						
St	D ₁	D ₂	D ₃	D ₄	D ₅	D ₆	D ₇	D ₈	D ₉	Sp																									

61 digits or more		Not to be drawn																																	

(2) Modulus 43 check

No. of Input Digits																																			
Min. 2 digits Max. 60 digits (including C/D)	Input Data	<table border="1"> <tr> <td>St</td><td>D₁</td><td>D₂</td><td>D₃</td><td>D₄</td><td>D₅</td><td>D₆</td><td>D₇</td><td>D₈</td><td>D₉</td><td>Sp</td> </tr> <tr> <td colspan="10">Start code</td> <td>Stop code</td> </tr> <tr> <td colspan="11">To be checked as modulus 43 C/D</td> </tr> </table>	St	D ₁	D ₂	D ₃	D ₄	D ₅	D ₆	D ₇	D ₈	D ₉	Sp	Start code										Stop code	To be checked as modulus 43 C/D										
	St	D ₁	D ₂	D ₃	D ₄	D ₅	D ₆	D ₇	D ₈	D ₉	Sp																								
Start code										Stop code																									
To be checked as modulus 43 C/D																																			
Drawing Data	<table border="1"> <tr> <td>St</td><td>D₁</td><td>D₂</td><td>D₃</td><td>D₄</td><td>D₅</td><td>D₆</td><td>D₇</td><td>D₈</td><td>D₉</td><td>Sp</td> </tr> <tr> <td colspan="11">_____</td> </tr> </table>	St	D ₁	D ₂	D ₃	D ₄	D ₅	D ₆	D ₇	D ₈	D ₉	Sp	_____																						
St	D ₁	D ₂	D ₃	D ₄	D ₅	D ₆	D ₇	D ₈	D ₉	Sp																									

1 digit 61 digits or more		Not to be drawn																																	

(3) Auto affix of modulus 43

No. of Input Digits																																			
Max. 60 digits	Input Data	<table border="1"> <tr> <td>St</td><td>D₁</td><td>D₂</td><td>D₃</td><td>D₄</td><td>D₅</td><td>D₆</td><td>D₇</td><td>D₈</td><td>D₉</td><td>Sp</td> </tr> <tr> <td colspan="10">Start code</td> <td>Stop code</td> </tr> </table>	St	D ₁	D ₂	D ₃	D ₄	D ₅	D ₆	D ₇	D ₈	D ₉	Sp	Start code										Stop code											
	St	D ₁	D ₂	D ₃	D ₄	D ₅	D ₆	D ₇	D ₈	D ₉	Sp																								
Start code										Stop code																									
Drawing Data	<table border="1"> <tr> <td>St</td><td>D₁</td><td>D₂</td><td>D₃</td><td>D₄</td><td>D₅</td><td>D₆</td><td>D₇</td><td>D₈</td><td>D₉</td><td>C/D</td><td>Sp</td> </tr> <tr> <td colspan="11">_____</td> </tr> <tr> <td colspan="11">Affix a modulus 43 C/D.</td> </tr> </table>	St	D ₁	D ₂	D ₃	D ₄	D ₅	D ₆	D ₇	D ₈	D ₉	C/D	Sp	_____											Affix a modulus 43 C/D.										
St	D ₁	D ₂	D ₃	D ₄	D ₅	D ₆	D ₇	D ₈	D ₉	C/D	Sp																								

Affix a modulus 43 C/D.																																			
61 digits or more		Not to be drawn																																	

NOTE: Numerals under bars are not characters corresponding to the bars but the characters of the codes received are drawn.

Type of Bar Code: NW7

(1) No affix

C/D check

Auto affix

No. of Input Digits																								
Max. 125 digits	Input Data	<table border="1"> <tr> <td>St</td><td>D₁</td><td>D₂</td><td>D₃</td><td>D₄</td><td>D₅</td><td>D₆</td><td>D₇</td><td>D₈</td><td>D₉</td><td>Sp</td> </tr> <tr> <td colspan="10">Start code</td> <td>Stop code</td> </tr> </table>	St	D ₁	D ₂	D ₃	D ₄	D ₅	D ₆	D ₇	D ₈	D ₉	Sp	Start code										Stop code
	St	D ₁	D ₂	D ₃	D ₄	D ₅	D ₆	D ₇	D ₈	D ₉	Sp													
Start code										Stop code														
Drawing Data	<table border="1"> <tr> <td>St</td><td>D₁</td><td>D₂</td><td>D₃</td><td>D₄</td><td>D₅</td><td>D₆</td><td>D₇</td><td>D₈</td><td>D₉</td><td>Sp</td> </tr> <tr> <td colspan="11">_____</td> </tr> </table>	St	D ₁	D ₂	D ₃	D ₄	D ₅	D ₆	D ₇	D ₈	D ₉	Sp	_____											
St	D ₁	D ₂	D ₃	D ₄	D ₅	D ₆	D ₇	D ₈	D ₉	Sp														

126 digits or more		Not to be drawn																						

Type of Bar Code: No auto selection of CODE128 (Character ">" to be also counted as a digit)

- (1) No affix
- PSEUDO103 check
- Auto affix of PSEUDO103

No. of Input Digits		
Min. 3 digits Max. 125 digits (including start code)	Input Data	St D ₁ D ₂ D ₃ D ₄ D ₅ D ₆ D ₇ D ₈ D ₉ D ₁₀ D ₁₁
	Drawing Data	St D ₁ D ₂ D ₃ D ₄ D ₅ D ₆ D ₇ D ₈ D ₉ D ₁₀ D ₁₁ C/D Sp <div style="text-align: right; margin-top: -10px;">└ Affix PSEUDO103 C/D.</div>
2 digits or less 126 digits or more		Not to be drawn

NOTE: The following characters are not drawn as numerals under bars.
 NUL (00H) to US (1FH), FNC1, FNC2, FNC3, SHIFT, CODE A, CODE B, CODE C

Type of Bar Code: Auto selection of CODE128

- (1) No affix
- C/D check
- Auto affix of C/D

No. of Input Digits		
Max. 60 digits	Input Data	D ₁ D ₂ D ₃ D ₄ D ₅ D ₆ D ₇ D ₈ D ₉ D ₁₀ D ₁₁
	Drawing Data	St D ₁ D ₂ D ₃ D ₄ AD D ₅ D ₆ D ₇ AD D ₈ D ₉ D ₁₀ D ₁₁ C/D Sp <div style="display: flex; justify-content: space-between; margin-top: -10px;"> └ Start code └ Selection code └ Stop code </div> <div style="text-align: right; margin-top: 10px;">└ Affix PSEUDO103 C/D.</div>
61 digits or more		Not to be drawn

NOTE: The following characters are not drawn as numerals under bars.
 NUL (00H) to US (1FH), FNC1, FNC2, FNC3, SHIFT, CODE A, CODE B, CODE C

Type of Bar Code: CODE93

- (1) No affix
- C/D check
- Auto affix of C/D

No. of Input Digits		
Max. 60 digits	Input Data	D ₁ D ₂ D ₃ D ₄ D ₅ D ₆ D ₇ D ₈ D ₉
	Drawing Data	
61 digits or more		Not to be drawn

NOTE: Numerals under bars are not characters corresponding to the bars but the characters of the codes received are drawn.

Type of Bar Code: UCC/EAN128

- (1) No affix
- C/D check
- Auto affix of C/D

No. of Input Digits		
19 digits	Input Data	D ₁ D ₂ D ₃ D ₄ D ₅ D ₆ --- D ₁₄ D ₁₅ D ₁₆ D ₁₇ D ₁₈ D ₁₉
	Drawing Data	
Other than 19 digits		Not to be drawn

Type of Bar Code: POSTNET

(1) Auto affix of dedicated C/D

No. of Input Digits																		
5 digits	Input Data	D ₁ D ₂ D ₃ D ₄ D ₅																
	Drawing Data	<table border="1" style="border-collapse: collapse; width: 100%;"> <tr> <td style="width: 20px;">St</td> <td style="width: 20px;">D₁</td> <td style="width: 20px;">D₂</td> <td style="width: 20px;">D₃</td> <td style="width: 20px;">D₄</td> <td style="width: 20px;">D₅</td> <td style="width: 20px;">C/D</td> <td style="width: 20px;">Sp</td> </tr> </table> <p style="margin-left: 20px;">└ Start code</p> <p style="margin-left: 500px;">└ Stop code</p> <p style="margin-left: 350px;">└ Dedicated check digit</p>	St	D ₁	D ₂	D ₃	D ₄	D ₅	C/D	Sp								
St	D ₁	D ₂	D ₃	D ₄	D ₅	C/D	Sp											
9 digits	Input Data	D ₁ D ₂ D ₃ D ₄ D ₅ D ₆ D ₇ D ₈ D ₉																
	Drawing Data	<table border="1" style="border-collapse: collapse; width: 100%;"> <tr> <td style="width: 20px;">St</td> <td style="width: 20px;">D₁</td> <td style="width: 20px;">D₂</td> <td style="width: 20px;">D₃</td> <td style="width: 20px;">D₄</td> <td style="width: 20px;">D₅</td> <td style="width: 20px;">D₆</td> <td style="width: 20px;">D₇</td> <td style="width: 20px;">D₈</td> <td style="width: 20px;">D₉</td> <td style="width: 20px;">C/D</td> <td style="width: 20px;">Sp</td> </tr> </table> <p style="margin-left: 20px;">└ Start code</p> <p style="margin-left: 650px;">└ Stop code</p> <p style="margin-left: 500px;">└ Dedicated check digit</p>	St	D ₁	D ₂	D ₃	D ₄	D ₅	D ₆	D ₇	D ₈	D ₉	C/D	Sp				
St	D ₁	D ₂	D ₃	D ₄	D ₅	D ₆	D ₇	D ₈	D ₉	C/D	Sp							
11 digits	Input Data	D ₁ D ₂ D ₃ D ₄ D ₅ D ₆ D ₇ D ₈ D ₉ D ₁₀ D ₁₁																
	Drawing Data	<table border="1" style="border-collapse: collapse; width: 100%;"> <tr> <td style="width: 20px;">St</td> <td style="width: 20px;">D₁</td> <td style="width: 20px;">D₂</td> <td style="width: 20px;">D₃</td> <td style="width: 20px;">D₄</td> <td style="width: 20px;">D₅</td> <td style="width: 20px;">C/D</td> <td style="width: 20px;">Sp</td> <td style="width: 20px;">Fr</td> <td style="width: 20px;">D₆</td> <td style="width: 20px;">D₇</td> <td style="width: 20px;">D₈</td> <td style="width: 20px;">D₉</td> <td style="width: 20px;">D₁₀</td> <td style="width: 20px;">D₁₁</td> <td style="width: 20px;">C/D</td> <td style="width: 20px;">Fr</td> </tr> </table> <p style="margin-left: 20px;">└ Start code</p> <p style="margin-left: 350px;">└ Frame</p> <p style="margin-left: 350px;">└ Stop code</p> <p style="margin-left: 500px;">└ Dedicated check digit</p> <p style="margin-left: 850px;">└ Frame</p>	St	D ₁	D ₂	D ₃	D ₄	D ₅	C/D	Sp	Fr	D ₆	D ₇	D ₈	D ₉	D ₁₀	D ₁₁	C/D
St	D ₁	D ₂	D ₃	D ₄	D ₅	C/D	Sp	Fr	D ₆	D ₇	D ₈	D ₉	D ₁₀	D ₁₁	C/D	Fr		
Other than 5, 9, and 11 digits		Not to be drawn																

Type of Bar Code: RM4SCC

(1) Auto affix of dedicated C/D

No. of Input Digits																
12 digits	Input Data	(St) D ₁ D ₂ D ₃ D ₄ D ₅ D ₆ D ₇ D ₈ D ₉ D ₁₀ D ₁₁ D ₁₂ (Sp)														
	Drawing Data	<table border="1" style="border-collapse: collapse; width: 100%;"> <tr> <td style="width: 20px;">St</td> <td style="width: 20px;">D₁</td> <td style="width: 20px;">D₂</td> <td style="width: 20px;">D₃</td> <td style="width: 20px;">D₄</td> <td style="width: 20px;">D₅</td> <td style="width: 20px;">D₆</td> <td style="width: 20px;">D₇</td> <td style="width: 20px;">D₈</td> <td style="width: 20px;">D₉</td> <td style="width: 20px;">D₁₀</td> <td style="width: 20px;">D₁₁</td> <td style="width: 20px;">D₁₂</td> <td style="width: 20px;">C/D</td> <td style="width: 20px;">Sp</td> </tr> </table> <p style="margin-left: 20px;">└ Start code</p> <p style="margin-left: 650px;">└ Stop code</p> <p style="margin-left: 500px;">└ Dedicated check digit</p>	St	D ₁	D ₂	D ₃	D ₄	D ₅	D ₆	D ₇	D ₈	D ₉	D ₁₀	D ₁₁	D ₁₂	C/D
St	D ₁	D ₂	D ₃	D ₄	D ₅	D ₆	D ₇	D ₈	D ₉	D ₁₀	D ₁₁	D ₁₂	C/D	Sp		
13 digits or more		Not to be drawn														

Type of Bar Code: KIX CODE

(1) No affix

No. of Input Digits		
18 digits	Input Data	D ₁ D ₂ D ₃ D ₄ D ₅ D ₆ D ₇ D ₈ D ₉ D ₁₀ D ₁₁ D ₁₂ D ₁₃ D ₁₄ D ₁₅ D ₁₆ D ₁₇ D ₁₈
	Drawing Data	D ₁ D ₂ D ₃ D ₄ D ₅ D ₆ D ₇ D ₈ D ₉ D ₁₀ D ₁₁ D ₁₂ D ₁₃ D ₁₄ D ₁₅ D ₁₆ D ₁₇ D ₁₈
19 digits or more		Not to be drawn

Type of Bar Code: Customer bar code

(1) Auto affix of dedicated C/D

No. of Input Digits																								
20 digits	Input Data	D ₁ D ₂ D ₃ D ₄ D ₅ D ₆ D ₇ D ₈ D ₉ D ₁₀ D ₁₁ D ₁₂ D ₁₃ D ₁₄ D ₁₅ D ₁₆ D ₁₇ D ₁₈ D ₁₉ D ₂₀																						
	Drawing Data	<table border="1" style="width: 100%; border-collapse: collapse;"> <tr> <td style="width: 20px;">St</td> <td style="width: 20px;">D₁</td> <td style="width: 20px;">D₂</td> <td style="width: 20px;">D₃</td> <td style="width: 20px;">D₄</td> <td style="width: 20px;">D₅</td> <td style="width: 20px;">D₆</td> <td style="width: 20px;">D₇</td> <td style="width: 20px;">D₈</td> <td style="width: 20px;">D₉</td> <td style="width: 20px;">D₁₀</td> <td style="width: 20px;">D₁₁</td> <td style="width: 20px;">D₁₂</td> <td style="width: 20px;">D₁₃</td> <td style="width: 20px;">D₁₄</td> <td style="width: 20px;">D₁₅</td> <td style="width: 20px;">D₁₆</td> <td style="width: 20px;">D₁₇</td> <td style="width: 20px;">D₁₈</td> <td style="width: 20px;">D₁₉</td> <td style="width: 20px;">D₂₀</td> <td style="width: 20px;">C/D</td> <td style="width: 20px;">Sp</td> </tr> </table> <p style="margin-left: 20px;">Start code</p> <p style="margin-left: 160px;">Dedicated check digit</p> <p style="margin-left: 180px;">Stop code</p>	St	D ₁	D ₂	D ₃	D ₄	D ₅	D ₆	D ₇	D ₈	D ₉	D ₁₀	D ₁₁	D ₁₂	D ₁₃	D ₁₄	D ₁₅	D ₁₆	D ₁₇	D ₁₈	D ₁₉	D ₂₀	C/D
St	D ₁	D ₂	D ₃	D ₄	D ₅	D ₆	D ₇	D ₈	D ₉	D ₁₀	D ₁₁	D ₁₂	D ₁₃	D ₁₄	D ₁₅	D ₁₆	D ₁₇	D ₁₈	D ₁₉	D ₂₀	C/D	Sp		
21 digits or more		Data of up to 20 digits is drawn. Data of 21 digits or more is discarded.																						

Type of Bar Code: Highest priority customer bar code

(1) Auto affix of dedicated C/D

No. of Input Digits																								
19 digits	Input Data	D ₁ D ₂ D ₃ D ₄ D ₅ D ₆ D ₇ D ₈ D ₉ D ₁₀ D ₁₁ D ₁₂ D ₁₃ D ₁₄ D ₁₅ D ₁₆ D ₁₇ D ₁₈ D ₁₉																						
	Drawing Data	<table border="1" style="width: 100%; border-collapse: collapse;"> <tr> <td style="width: 20px;">St</td> <td style="width: 20px;">D₁</td> <td style="width: 20px;">D₂</td> <td style="width: 20px;">D₃</td> <td style="width: 20px;">D₄</td> <td style="width: 20px;">D₅</td> <td style="width: 20px;">D₆</td> <td style="width: 20px;">D₇</td> <td style="width: 20px;">D₈</td> <td style="width: 20px;">D₉</td> <td style="width: 20px;">D₁₀</td> <td style="width: 20px;">D₁₁</td> <td style="width: 20px;">D₁₂</td> <td style="width: 20px;">D₁₃</td> <td style="width: 20px;">D₁₄</td> <td style="width: 20px;">D₁₅</td> <td style="width: 20px;">D₁₆</td> <td style="width: 20px;">D₁₇</td> <td style="width: 20px;">D₁₈</td> <td style="width: 20px;">D₁₉</td> <td style="width: 20px;">CC7</td> <td style="width: 20px;">C/D</td> <td style="width: 20px;">Sp</td> </tr> </table> <p style="margin-left: 20px;">Start code</p> <p style="margin-left: 160px;">CC7</p> <p style="margin-left: 180px;">Dedicated check digit</p> <p style="margin-left: 180px;">Stop code</p>	St	D ₁	D ₂	D ₃	D ₄	D ₅	D ₆	D ₇	D ₈	D ₉	D ₁₀	D ₁₁	D ₁₂	D ₁₃	D ₁₄	D ₁₅	D ₁₆	D ₁₇	D ₁₈	D ₁₉	CC7	C/D
St	D ₁	D ₂	D ₃	D ₄	D ₅	D ₆	D ₇	D ₈	D ₉	D ₁₀	D ₁₁	D ₁₂	D ₁₃	D ₁₄	D ₁₅	D ₁₆	D ₁₇	D ₁₈	D ₁₉	CC7	C/D	Sp		
20 digits or more		Data of up to 19 digits is drawn. Data of 20 digits or more is discarded.																						

14. AUTOMATIC ADDING OF START/STOP CODE

Type of Bar Code	Designation of Start/Stop Code	Input Data	Drawing Data	
CODE 39	Omit (No designation)	12345ABC	Standard	*12345ABC*
			Full ASCII	*12345ABC*
		*12345ABC	Standard	*12345ABC*
			Full ASCII	*12345ABC*
		12345ABC*	Standard	*12345ABC*
			Full ASCII	*12345ABC*
		12345ABC	Standard	*12345ABC*
			Full ASCII	*12345ABC*
		12345*ABC	Standard	*12345*ABC*
			Full ASCII	*12345/JABC*
		**12345ABC	Standard	**12345ABC*
			Full ASCII	*/J12345ABC*
		*12345ABC**	Standard	*12345ABC**
			Full ASCII	*12345ABC/J*
		*12345*ABC*	Standard	*12345*ABC*
			Full ASCII	*12345/JABC*
	Add start code	12345ABC	Standard	*12345ABC
			Full ASCII	*12345ABC
		*12345ABC	Standard	**12345ABC
			Full ASCII	*/J12345ABC
		12345ABC*	Standard	*12345ABC*
			Full ASCII	*12345ABC*
		12345ABC	Standard	**12345ABC*
			Full ASCII	*/J12345ABC*
		12345*ABC	Standard	*12345*ABC
			Full ASCII	*12345/JABC
		12345ABC	Standard	*12345ABC
			Full ASCII	*/J/J12345ABC
		*12345ABC**	Standard	**12345ABC**
			Full ASCII	*/J12345ABC/J*
		*12345*ABC*	Standard	**12345*ABC*
			Full ASCII	*/J12345/JABC*
	Add stop code	12345ABC	Standard	12345ABC*
			Full ASCII	12345ABC*
		*12345ABC	Standard	*12345ABC*
			Full ASCII	*12345ABC*
		12345ABC*	Standard	12345ABC**
			Full ASCII	12345ABC/J*
		12345ABC	Standard	*12345ABC**
			Full ASCII	*12345ABC/J*
		12345*ABC	Standard	12345*ABC*
			Full ASCII	12345/JABC*
		**12345ABC	Standard	**12345ABC*
			Full ASCII	*/J12345ABC*
		*12345ABC**	Standard	*12345ABC***
			Full ASCII	*12345ABC/J/J*
		*12345*ABC*	Standard	*12345*ABC**
			Full ASCII	*12345/JABC/J*

Type of Bar Code	Designation of Start/Stop Code	Input Data	Drawing Data	
CODE 39	Start/stop code not added	12345ABC	Standard	12345ABC
			Full ASCII	12345ABC
		*12345ABC	Standard	*12345ABC
			Full ASCII	*12345ABC
		12345ABC*	Standard	12345ABC*
			Full ASCII	12345ABC*
		12345ABC	Standard	*12345ABC*
			Full ASCII	*12345ABC*
		12345*ABC	Standard	12345*ABC
			Full ASCII	12345/JABC
		**12345ABC	Standard	**12345ABC
			Full ASCII	*/J12345ABC
		*12345ABC**	Standard	*12345ABC**
			Full ASCII	*12345ABC/J*
		*12345*ABC*	Standard	*12345*ABC*
			Full ASCII	*12345/JABC*

Type of Bar Code	Designation of Start/Stop Code	Input Data	Drawing Data
NW7	Omit (No designation)	12345678	a12345678a
		a12345678	a12345678
		12345678c	12345678c
		b12345678d	b12345678d
		12345a678	a12345a678a
		ab12345678	ab12345678
		a12345678bc	a12345678bc
		d12345b678c	d12345b678c
	Add start code	12345678	a12345678
		a12345678	aa12345678
		12345678c	a12345678c
		b12345678d	ab12345678d
		12345a678	a12345a678
		ab12345678	aab12345678
		a12345678bc	aa12345678bc
		d12345b678c	ad12345b678c
	Add stop code	12345678	12345678a
		a12345678	a12345678a
		12345678c	12345678ca
		b12345678d	b12345678da
		12345a678	12345a678a
		ab12345678	ab12345678a
		a12345678bc	a12345678bca
		d12345b678c	d12345b678ca
	Start/stop code not added	12345678	12345678
		a12345678	a12345678
		12345678c	12345678c
		b12345678d	b12345678d
		12345a678	12345a678
		ab12345678	ab12345678
		a12345678bc	a12345678bc
		d12345b678c	d12345b678c