

TOSHIBA

TOSHIBA Bar Code Printer

B-SX4T Series, B-SX5T Series

External Equipment Interface Specification

First Edition:	November 18, 2002
Second Edition:	February 21, 2003
Third Edition:	June 6, 2003
Fourth Edition:	August 22, 2003
Fifth Edition:	February 27, 2004
Sixth Edition:	January 14, 2005
Seventh Edition:	February 8, 2005
Eighth Edition:	May 9, 2005
Ninth Edition:	April 4, 2006
Tenth Edition:	May 23, 2007

TOSHIBA TEC CORPORATION

TABLE OF CONTENTS

	Page
1. SCOPE	1
2. GENERAL DESCRIPTION.....	1
3. INTERFACE	4
3.1 SERIAL INTERFACE.....	4
3.2 PARALLEL INTERFACE	9
3.3 USB INTERFACE	19
3.4 NETWORK INTERFACE.....	19
4. KEY OPERATION FUNCTIONS.....	20
4.1 SYSTEM MODE FUNCTIONS	20
4.2 ONLINE MODE FUNCTIONS	25
4.3 DOWNLOAD MODE SETTING FUNCTION	25
5. TRANSMISSION SEQUENCE.....	26
5.1 INITIALIZATION	26
5.2 LABEL ISSUE OPERATION	28
6. INTERFACE COMMANDS.....	30
6.1 OUTLINE OF COMMANDS.....	30
6.2 LIST OF COMMANDS.....	31
6.3 COMMANDS FOR CREATING APPLICATION	33
6.3.1 LABEL SIZE SET COMMAND	33
6.3.2 POSITION FINE ADJUST COMMAND	39
6.3.3 PRINT DENSITY FINE ADJUST COMMAND.....	47
6.3.4 RIBBON MOTOR DRIVE VOLTAGE FINE ADJUST COMMAND.....	48
6.3.5 IMAGE BUFFER CLEAR COMMAND	49
6.3.6 CLEAR AREA COMMAND.....	50
6.3.7 LINE FORMAT COMMAND	52
6.3.8 BIT MAP FONT FORMAT COMMAND	56
6.3.9 OUTLINE FONT FORMAT COMMAND.....	73
6.3.10 BAR CODE FORMAT COMMAND	90
6.3.11 BIT MAP FONT DATA COMMAND.....	136
6.3.12 OUTLINE FONT DATA COMMAND	141
6.3.13 BAR CODE DATA COMMAND	144
6.3.14 ISSUE COMMAND.....	157
6.3.15 FEED COMMAND	173
6.3.16 EJECT COMMAND	180
6.3.17 FORWARD/REVERSE FEED COMMAND.....	182
6.3.18 STORAGE AREA ALLOCATE COMMAND	184
6.3.19 FLASH MEMORY FORMAT COMMAND	186
6.3.20 ATA CARD FORMAT COMMAND.....	187

	Page
6.3.21 2-BYTE WRITABLE CHARACTER CODE RANGE COMMAND	188
6.3.22 BIT MAP WRITABLE CHARACTER COMMAND ([ESC] XD)	189
6.3.23 BIT MAP WRITABLE CHARACTER COMMAND ([ESC] XA)	190
6.3.24 GRAPHIC COMMAND	201
6.3.25 SAVE START COMMAND ([ESC] XO)	209
6.3.26 SAVE START COMMAND ([ESC] XV)	210
6.3.27 SAVE TERMINATE COMMAND	211
6.3.28 SAVED DATA CALL COMMAND ([ESC] XQ)	212
6.3.29 SAVED DATA CALL COMMAND ([ESC] XT)	213
6.3.30 HEAD BROKEN DOTS CHECK COMMAND	214
6.3.31 MESSAGE DISPLAY COMMAND	215
6.3.32 RESET COMMAND.....	217
6.3.33 STATUS REQUEST COMMAND.....	218
6.3.34 RECEIVE BUFFER FREE SPACE REQUEST COMMAND.....	219
6.3.35 VERSION INFORMATION ACQUIRE COMMAND	220
6.3.36 ATA CARD INFORMATION ACQUIRE COMMAND	221
6.3.37 ATA CARD WRITABLE CHARACTER INFORMATION ACQUIRE COMMAND	223
6.3.38 PRINTER OPTION STATUS ACQUIRE COMMAND	224
6.3.39 IP ADDRESS SET COMMAND.....	225
6.3.40 SOCKET COMMUNICATION PORT SET COMMAND	226
6.3.41 DHCP FUNCTION SET COMMAND.....	227
6.3.42 PASS-THROUGH COMMAND	228
6.3.43 INTERNAL SERIAL INTERFACE PARAMETER SET COMMAND.....	229
6.4 COMMANDS FOR SYSTEM ADMINISTRATOR.....	230
6.4.1 PARAMETER SET COMMAND.....	230
6.4.2 FINE ADJUSTMENT VALUE SET COMMAND	234
6.4.3 RFID PARAMETER SET COMMAND.....	236
6.4.4 BATCH RESET COMMAND	238
6.5 COMMANDS RELATED TO RFID	239
6.5.1 RFID TAG POSITION ADJUSTMENT COMMAND	239
6.5.2 RFID TAG READ COMMAND.....	240
6.5.3 RFID VOID PATTERN PRINT COMMAND	243
6.5.4 RFID DATA WRITE COMMAND.....	244
7. CONTROL CODE SELECTION.....	248
8. ERROR PROCESSING.....	249
8.1 COMMUNICATION ERRORS.....	249
8.2 ERRORS IN ISSUING OR FEEDING	249
8.3 ERRORS IN WRITABLE CHARACTER AND PC COMMAND SAVE MODES.....	252
8.4 SYSTEM ERRORS.....	252
8.5 RESET PROCESSING.....	252
8.6 RFID ERROR	253

1. SCOPE

This specification applies to the external equipment interface for use with the B-SX4T-GS10/20-QQ/QP/CN/QQ-US and B-SX4T-GS10-QQ-CCS (hereinafter referred to as “B-SX4T”) and B-SX5T-TS12/22-QQ/QP/CN/QQ-US (hereinafter referred to as “B-SX5T”) industrial high-performance class general-purpose bar code printers.

2. GENERAL DESCRIPTION

The external equipment interface connects a printer to the host computer through a serial interface (RS-232C/USB), parallel interface (Centronics), or a network for making various settings and printing labels.

This specification describes how to use the external equipment interface for the TPCL (TEC Printer Command Language).

The following table shows the combination of the main program and the boot program. As shown below, some combinations disable the proper printer operation.

Boot program Main program	V1.0	V1.1	V1.1A	V2.0	V2.0A	V2.0B
V1.0	○	○	X	X	X	X
V1.0A	○	○	X	X	X	X
V1.0B	○	○	X	X	X	X
V1.0C	○	○	X	X	X	X
V1.0D	○	○	X	X	X	X
V1.1	○	○	X	X	X	X
V1.1A	○	○	X	X	X	X
V1.1B	○	○	X	X	X	X
V1.2	○	○	X	X	X	X
V1.2A	○	○	X	X	X	X
V1.2B	○	○	X	X	X	X
V2.0	○	○	X	○	X	X
V2.0A	X	X	○	X	○	○
V2.0B	X	X	○	X	○	○
V2.1	X	X	○	X	○	○
V3.0	X	X	○	X	○	○
V3.1	X	X	○	X	○	○
V3.2	X	X	○	X	○	○
V3.3	X	X	○	X	○	○
V3.3A	X	X	○	X	○	○
V4.1	X	X	○	X	○	○
V4.2	X	X	○	X	○	○
V4.2A	X	X	○	X	○	○
V4.4	X	X	○ ^(Note2)	X	○ ^(Note2)	○
V4.4A	X	X	○	X	○	○

○: This combination enables the proper printer operation.

X: This combination disables the proper printer operation.

NOTES: 1. Some program versions are not released actually.

2. Boot programs V1.1A and V2.0A do not support the SNMP function as they are not able to download this function. Any other functions than the SNMP function are supported.

The model configuration and the differences between the models of the B-SX series are described below.

Model		B-SX4T-GS10/20-QQ/QQ-US, B-SX4T-GS10-QQ-CCS	B-SX4T-GS10/20-QP	B-SX4T-GS10/20-CN
Memory	Flash ROM		4 MB × 1 = 4 MB	
	SDRAM	Whole	8 MB × 1 = 8 MB	
		Image buffer of whole SDRAM	1.2 MB (Label length: 1500 mm) When the SNMP function is enabled: 0.6 MB (Label length: 750 mm)	
Chinese ROM		None	Future specification	
RS-232C		Standard		
Centronics		Standard		
USB board		Option		
100BASE LAN board		Option		
Ribbon save module		Option		
Swing cutter module		Option		
Rotary cutter module		Option		
Strip module		Option		
PCMCIA board		Option		
Expansion I/O board		Option		
RFID module (UHF band for US)		Option	None	None
RFID module (UHF band for EU)		None	Option	None
RFID module (HF band for QM)		None	Option	None

Model		B-SX5T-TS12/22-QQ	B-SX5T-TS12/22-QP	B-SX5T-TS12/22-CN
Memory	Flash ROM		4 MB × 1 = 4 MB	
	SDRAM	Whole	16 MB × 1 = 16 MB	
		Image buffer of whole SDRAM	3.3 MB (Label length: 1500 mm) When the SNMP function is enabled: 1.65 MB (Label length: 750 mm)	
Chinese ROM		None	Standard	
RS-232C		Standard		
Centronics		Standard		
USB board		Option		
100BASE LAN board		Option		
Ribbon save module		Standard		
Swing cutter module		Option		
Rotary cutter module		Option		
Strip module		Standard		
PCMCIA board		Option		
Expansion I/O board		Standard		
RFID module (UHF band for US)		Option	None	None
RFID module (UHF band for EU)		None	Option	None
RFID module (HF band for QM)		None	Option	None

Available PCMCIA cards

- LAN card
SCCE589ET series only, manufactured by 3COM
- ATA card
ATA flash card using flash memory manufactured by SanDisk or HITACHI.
- Flash memory card

Capacity	Manufacturer	Item Code	Device Code	Manufacturer's Code	Operation	
1 MB	Maxell	EF-1M-TB AA	D0H	1CH	Read only	
	Mitsubishi	MF81M1-GBDAT01				
4 MB	Maxell	EF-4M-TB CC	88H	B0H	Read/Write	
	Maxell	EF-4M-TB DC	ADH	04H		
	Centennial Technologies INC.	FL04M-15-11119-03		01H		
	INTEL	IMC004FLSA	A2H	89H	Read only	
	Simple TECHNOLOGY	STI-FL/4A				
	Mitsubishi	MF84M1-G7DAT01				
	PC Card KING MAX	FJN-004M6C				
	Centennial Technologies INC.	FL04M-20-11138-67				
	PC Card	FJP-004M6R				A0H
	Mitsubishi	MF84M1-GMCAV01				AAH

3. INTERFACE

3.1 SERIAL INTERFACE

- (1) Type: Conforming to RS-232C
- (2) Mode of Communication: Full duplex
- (3) Transmission Speed: 2400 bps
4800 bps
9600 bps
19200 bps
38400 bps
115200 bps
- (4) Synchronization Method: Start-stop synchronization
- (5) Start Bit: 1 bit
- (6) Stop Bit: 1 bit
2 bits
- (7) Data Length: 7 bits
8 bits
- (8) Parity: None
Even
Odd
- (9) Error Detection: Parity error Vertical parity error check
Framing error This error occurs if no stop bit is found in the frame specified starting with the start bit.
- (10) Protocol: No-procedure method
- (11) Data Input Code: ASCII code
European character set 8 bit code
Graphics 8 bit code
- (12) Receive Buffer: For B-SX4T: 1 MB
For B-SX5T: 6 MB

* The use of the receive buffer is shared between interfaces.

(13) Transmission Control: XON/XOFF (DC1/DC3) Protocol
READY/BUSY (DTR) Protocol
XON/XOFF (DC1/DC3) Protocol + READY/BUSY (DTR) Protocol
READY/BUSY (RTS) Protocol

① XON/XOFF (DC1/DC3) Protocol

- When initialized after the power is turned on, this printer becomes ready to receive data and sends an XON code (11H). (Transmission or non-transmission of the XON code is selectable by means of the parameter setting.)
- The printer sends an XOFF code (13H) when the blank positions in the receive buffer become 10 Kbytes or less.
- The printer sends an XON code (11H) when the blank positions in the receive buffer become 512 Kbytes or more.
- When there are no blank positions in the receive buffer, the printer discards data received exceeding the receive buffer capacity, without storing it in the buffer. (After detecting the XOFF code, the host computer must stop transmission before the printer receive buffer becomes full.)
- The printer sends an XOFF code (13H) when the power is off. (Transmission or non-transmission of the XOFF code is selectable by means of the parameter setting.)
- The DTR signal is always “High” (READY).
- The RTS signal is always “High”.

② READY/BUSY (DTR) Protocol

- When initialized after the power is turned on, this printer becomes ready to receive data and turns the DTR signal to “High” level (READY).
- The printer turns the DTR signal to “Low” level (BUSY) when the blank positions in the receive buffer become 10 Kbytes or less.
- The printer turns the DTR signal to “High” level (READY) when the blank positions in the receive buffer become 512 Kbytes or more.
- When there are no blank positions in the receive buffer, the printer discards data received exceeding the receive buffer capacity, without storing it in the buffer. (After detecting the BUSY signal, the host computer must stop transmission before the printer receive buffer becomes full.)
- The RTS signal is always “High”.

③ XON/XOFF (DC1/DC3) Protocol + READY/BUSY (DTR) Protocol

- When initialized after the power is turned on, this printer becomes ready to receive data and turns the DTR signal to “High” level (READY). The printer also sends an XON code (11H).
- When the blank positions in the receive buffer become 10 Kbytes or less, the printer turns the DTR signal to “Low” level (BUSY) and sends an XOFF code (13H).
- When the blank positions in the receive buffer become 512 Kbytes or more, the printer turns the DTR signal to “High” level (READY) and sends an XON code (11H).
- When there are no blank positions in the receive buffer, the printer discards data received exceeding the receive buffer capacity, without storing it in the buffer. (After detecting the XOFF code or BUSY signal, the host computer must stop transmission before the printer receive buffer becomes full.)
- The printer sends an XOFF code (13H) when the power is off.
- The RTS signal is always “High”.

④ READY/BUSY (RTS) Protocol

- When initialized after the power is turned on, this printer turns the RTS signal to “High” (READY).
- The printer turns the RTS signal to “Low” (BUSY) when the blank positions in the receive buffer become 10 Kbytes or less.
- The printer turns the RTS signal to “High” (READY) when the blank positions in the receive buffer become 512 Kbytes or more.
- When there are no blank positions in the receive buffer, the printer discards data received exceeding the receive buffer capacity, without storing it in the buffer. (After detecting the BUSY signal, the host computer must stop transmission before the printer receive buffer becomes full.)
- The DTR signal is always “High” (READY).
- The DSR signal from the host must always be “High”.

* When the flow control is performed with a Windows PC, “READY/BUSY (RTS) protocol” should be selected, and “Hardware” should be selected for the flow control in the Windows communication port setting.

NOTE: For “READY/BUSY (DTR) protocol”, data should be sent after 200 ms from when the DTR signal is turned to “High” (READY). For “READY/BUSY (RTS) protocol”, data should be sent after 200 ms from when the RTS signal is turned to “High” (READY).

(14) Input/Output Signals

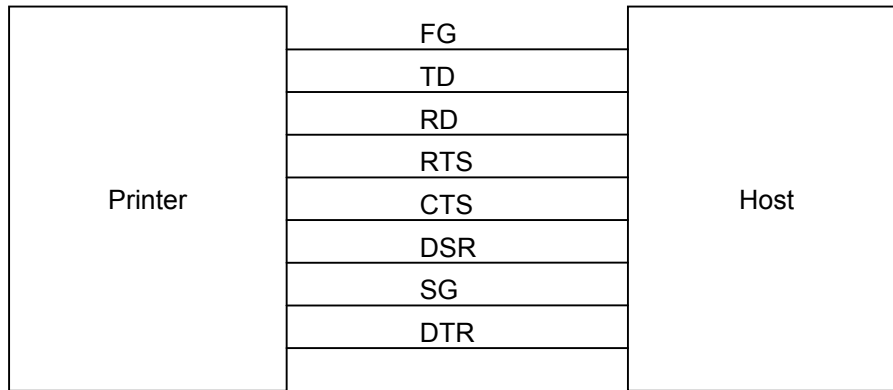

(15) Connector Pin Assignment and Signal Description

Pin No.	Signal Name	Function	Signal Direction
1	FG	<ul style="list-style-type: none"> ● Ground line for circuit protection 	
2	RD	<ul style="list-style-type: none"> ● Line for data which the printer receives from the host. ● Logic 1 is a Low level, while logic 0 is a High level. ● It is in the Low (Mark) state when no transmission is in progress. 	← Host
3	TD	<ul style="list-style-type: none"> ● Line for data which the printer sends to the host. ● Logic 1 is a Low level, while logic 0 is a High level. ● It is in the Low (Mark) state when no transmission is in progress. 	Printer →
4	CTS	<ul style="list-style-type: none"> ● It is an input signal indicating whether or not the data transmission to the host is possible. However, this printer does not detect this signal. 	← Host
5	RTS	<ul style="list-style-type: none"> ● Output signal to the host. <p>For the READY/BUSY (RTS) protocol:</p> <ul style="list-style-type: none"> ● It indicates the ready state for the received data. ● It is at “Low” when the receive buffer is nearly full, and at “High” when nearly empty. <p>For protocol other than the READY/BUSY (RTS) protocol:</p> <ul style="list-style-type: none"> ● After the power is turned on, it is always at “High” level. 	Printer →
6	DTR	<ul style="list-style-type: none"> ● Output signal to the host. <p>For the READY/BUSY (DTR) protocol or XON/XOFF (DC1/DC3) protocol + READY/BUSY (DTR) protocol:</p> <ul style="list-style-type: none"> ● It indicates the ready state for the received data. ● It is at “Low” level when the receive buffer is near full, and at “High” level when near empty. <p>For the XON/XOFF (DC1/DC3) protocol or READY/BUSY (RTS) protocol:</p> <ul style="list-style-type: none"> ● After the power is turned on, it is always at “High”. 	Printer →
7	SG	<ul style="list-style-type: none"> ● Ground line for all data and control signals. 	
20	DSR	<ul style="list-style-type: none"> ● Input signal from the host. ● For the printer to receive data, it must be at “High” level. 	← Host

(16) Interface Circuit

● Input Circuit

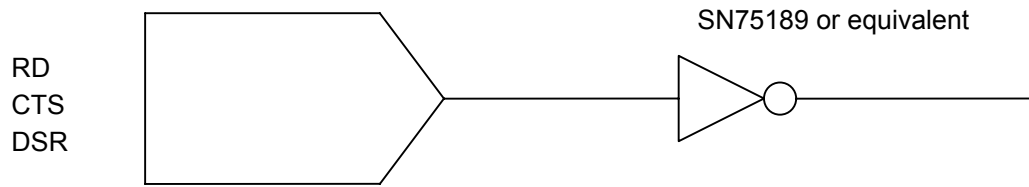

● Output Circuit

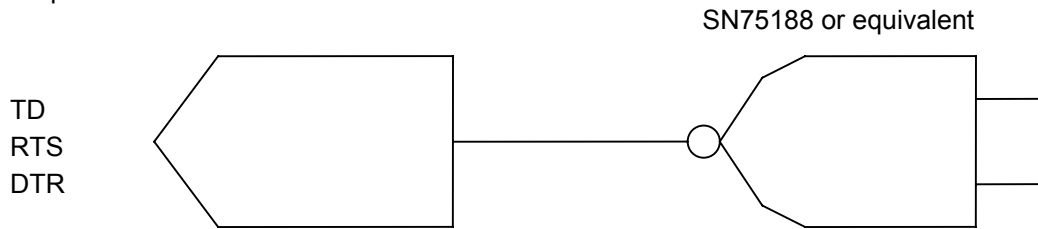

● Signal Levels

Input Voltage H +3 ~ +15 V
L -3 ~ -15 V

Output Voltage H +6 ~ +13 V
L -6 ~ -13 V

3.2 PARALLEL INTERFACE

- (1) Type: Centronics
- (2) Mode: Conforms to IEEE1284 Compatibility mode, Nibble mode, and ECP mode
- (3) Data Input Method: Parallel 8 bits (DATA1 ~ 8)
- (4) Control Signals:

Compatibility mode	Nibble mode	ECP mode
nStrobe	HostClk	HostClk
nAck	PrtClk	PeriphClk
Busy	PtrBusy	PeriphAck
PError	AckDataReq	nAckReverse
Select	Xflag	XFlag
nAutoFd	HostBusy	HostAck
nInit	nInit	nReverseRequest
nFault	nDataAvail	nPeriphRequest
nSelectIn	IEEE1284Active	IEEE1284Active
- (5) Data Input Code: ASCII code
European character set 8 bit code
Graphics 8 bit code
- (6) Receive Buffer: For B-SX4T: 1 MB
For B-SX5T: 6 MB

* The use of the receive buffer is shared between interfaces.

(7) Input/Output Circuit Configuration and Input/Output Conditions:

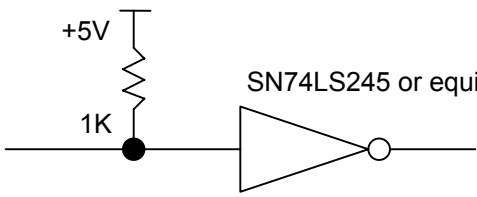
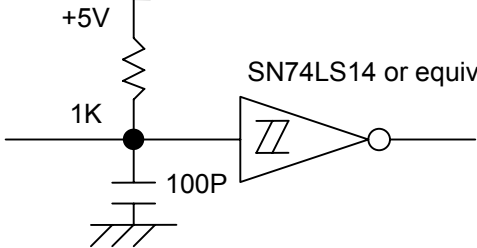
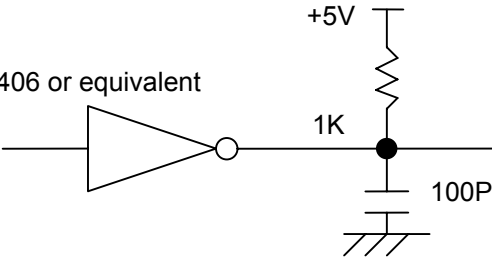
	Signal	Configuration	
Input	DATA1 ~ 8		Logic level (Input) "1" = 2 ~ 5 V "0" = 0 ~ 0.4 V
	nStrobe/HostClk/HostClk nInit/nInit/ nReverseRequest nAutoFd/HostBusy/ HostAck nSelectIn/IEEE1284Active/ IEEE1284Active		
Output	Busy/PtrBusy/PeriphAck nFault/nDataAvail/ nPeriphRequest nAck/PtrClk/PeriphClk Select/Xflag/XFlag PError/AckDataReq/ nAckReverse		Logic level (Input) "1" = 2.4 ~ 5 V "0" = 0 ~ 0.4 V

(8) Connector:

Printer

- Amp. Japan 552742-1 or equivalent
- DDK 57RE-40360-73B or equivalent

Cable

- Amp. Japan 552470-1 or equivalent
- DDK 57E-30360 or equivalent

(9) Connector Pin Diagram (IEEE1284-B Connector):

Pin No.	Signal Name		
	Compatibility Mode	Nibble mode	ECP mode
1	nStrobe	HostClk	HostClk
2	Data 1	Data 1	Data 1
3	Data 2	Data 2	Data 2
4	Data 3	Data 3	Data 3
5	Data 4	Data 4	Data 4
6	Data 5	Data 5	Data 5
7	Data 6	Data 6	Data 6
8	Data 7	Data 7	Data 7
9	Data 8	Data 8	Data 8
10	nAck	PtrClk	PeriphClk
11	Busy	PtrBusy	PeriphAck
12	PError	AckDataReq	nAckReverse
13	Select	Xflag	XFlag
14	nAutoFd	HostBusy	HostAck
15	NC	NC	NC
16	0V	0V	0V
17	CHASSIS GND	CHASSIS GND	CHASSIS GND
18	+5V (for detection)	+5V (for detection)	+5V (for detection)
19	TWISTED PAIR GND (PIN1)	TWISTED PAIR GND (PIN1)	TWISTED PAIR GND (PIN1)
20	TWISTED PAIR GND (PIN2)	TWISTED PAIR GND (PIN2)	TWISTED PAIR GND (PIN2)
21	TWISTED PAIR GND (PIN3)	TWISTED PAIR GND (PIN3)	TWISTED PAIR GND (PIN3)
22	TWISTED PAIR GND (PIN4)	TWISTED PAIR GND (PIN4)	TWISTED PAIR GND (PIN4)
23	TWISTED PAIR GND (PIN5)	TWISTED PAIR GND (PIN5)	TWISTED PAIR GND (PIN5)
24	TWISTED PAIR GND (PIN6)	TWISTED PAIR GND (PIN6)	TWISTED PAIR GND (PIN6)
25	TWISTED PAIR GND (PIN7)	TWISTED PAIR GND (PIN7)	TWISTED PAIR GND (PIN7)
26	TWISTED PAIR GND (PIN8)	TWISTED PAIR GND (PIN8)	TWISTED PAIR GND (PIN8)
27	TWISTED PAIR GND (PIN9)	TWISTED PAIR GND (PIN9)	TWISTED PAIR GND (PIN9)
28	TWISTED PAIR GND (PIN10)	TWISTED PAIR GND (PIN10)	TWISTED PAIR GND (PIN10)
29	TWISTED PAIR GND (PIN11)	TWISTED PAIR GND (PIN11)	TWISTED PAIR GND (PIN11)
30	TWISTED PAIR GND (PIN31)	TWISTED PAIR GND (PIN31)	TWISTED PAIR GND (PIN31)
31	nInIt	nInIt	nReverseRequest
32	nFault	nDataAvail	nPeriphRequest
33	0V	0V	0V
34	NC	NC	NC
35	NC	NC	NC
36	nSelectIn	IEEE1284Active	IEEE1284Active

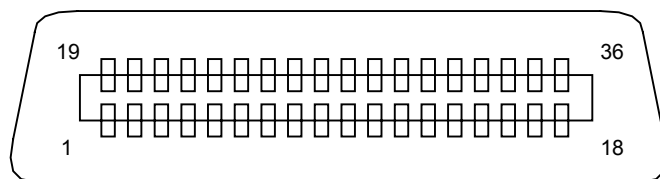

NOTE: The signal name starting with a lower case “n” indicates that it is a low active signal.

(10) Input/Output Signals :

Compatibility mode

- ① Data 1 ~ 8 (Printer ← Host)
 - Input data signals for the 1st to 8th bits.
 - Logic 1 is “High” level.
 - Min. data pulse width of 2.5 μ sec.
- ② nStrobe (Printer ← Host)
 - Synchronizing signal for reading the above data.
 - Normally at “High” level. The data is read at the rise of the Low level pulse.
 - Minimum data pulse width of 0.5 μ sec.
- ③ Busy (Printer → Host)
 - This signal indicates that the printer is in a Busy state.
 - When initialized after the power is turned on, the printer becomes ready to receive data and turns the signal to “Low” level.
 - The signal turns to “High” level (in a Busy state) when data is set from the host (at the fall of the nStrobe signal).
 - The signal turns to “Low” level when the printer reads the data.
 - When the blank positions in the receive buffer become 512 bytes or less, the printer keeps the signal at “High” level (in a Busy state) for 10 seconds when data is set from the host, to extend the data read interval.
 - When there are no blank positions in the receive buffer, the printer stops reading data. Then, it keeps the signal at “High” level (in a Busy state) until there are blank positions in the receive buffer when data is set from the host.
 - The signal is kept at “High” level (in a Busy state) until the current state (one of the following states) is reset.
 - PAUSE state caused by the [PAUSE] key
 - Paper end state
 - Ribbon end state
 - Head open state
 - Printer error state
 - Initialization in progress upon receipt of the nInit signal
- ④ nAck (Printer → Host)
 - This signal indicates that the printer has read the data set by the host and is ready to receive the next data.
 - The signal is normally at “High”. It is at “Low” for about 5 μ sec. after the fall of the BUSY signal. The host should usually set data after the ACK signal is turned from “Low” to “High”.
 - If the nAck signal is ignored and the next data is set while the nAck signal is Low, the “LOW” level continues about further 5 μ sec at the fall of the BUSY signal. However, the data can be received properly.

- ⑤ nInit (Printer ← Host)
- Reset request signal from the host.
 - Normally at “High” level. A low on this input causes the printer to be initialized in the same manner as when the power is turned on.
 - * When “Reset process when the nInit signal is ON” is set to “OFF” in the parameter setting in the system mode, the printer is not initialized even if it receives a low signal.
 - When the nInit signal is input during printing, the printer completes printing one tag/label which is being printed, cancels the next processing, then is initialized in the same manner as when the power is turned on.
 - * When “Reset process when the nInit signal is ON” is set to “OFF” in the parameter setting in the system mode, the next process proceeds without being canceled.
 - Minimum pulse width of 0.5 μsec.
- ⑥ Select (Printer → Host)
- This is an output signal which indicates whether the printer is in Pause state or placed online. The printer can receive data while placed online.
 - The signal is at “Low” level while the printer is in a Pause state.
 - The signal is kept at “Low” level (in a Pause state) until the current state (one of the following states) is reset.
 - Pause state caused by the [PAUSE] key
 - Paper end state
 - Ribbon end state
 - Head open state
 - Printer error state
 - Initialization in progress upon power on or receipt of the nInit signal
- ⑦ nFault (Printer → Host)
- Output signal indicating that the printer is in a Fault state.
 - At “Low” level while the printer is in a Fault state.
 - The signal is kept at “Low” level (in a Fault state) until the current state (one of the following states) is reset.
 - Pause state caused by the [PAUSE] key
 - Paper end state
 - Ribbon end state
 - Head open state
 - Printer error state
 - Initialization in progress upon power on or receipt of the nInit signal
- ⑧ PError (Printer → Host)
- Output signal indicating a label end or ribbon end state.
 - At “High” level when the printer is in a label end or ribbon end state.
 - Turns to “Low” level when the label end or ribbon end state is reset.
- ⑨ +5 V
- This is not a signal but a +5 V power supply voltage.
 - The maximum current of 500 mA can be taken out.
- ⑩ nSelectIn (Printer ← Host)
- Not used
- ⑪ nAutoFd (Printer ← Host)
- Not used

Nibble mode

- ① PtrClk (Printer → Host)
 - Reverse data transfer phase: It is used for evaluating data sent to the host.
 - Reverse idle phase: When the printer changes the signal from Low to High, an interrupt informing the host that the data is available, occurs
- ② PtrBusy (Printer → Host)
 - Reverse data transfer phase: Data bit 3 is used for the first transfer. Data bit 7 is used for the second transfer. Indicates the forward channel is in a Busy state.
- ③ AckDataReq (Printer → Host)
 - Reverse data transfer phase: Data bit 2 is used for the first transfer. Data bit 6 is used for the second transfer.
 - Reverse idle phase: This signal is set to high until the data transfer is requested by the host. Then, the process is performed according to the nDataAvail signal.
- ④ Xflag (Printer → Host)
 - Reverse data transfer phase: Data bit 1 is used for the first transfer. Data bit 5 is used for the second transfer.
- ⑤ HostBusy (Printer ← Host)
 - Reverse data transfer phase: It indicates that the host can receive data from the printer by setting the signal to low. Then, the host sets the signal to high, and sends the Ack indicating that the nibble data is received. When the signal is set to low after the reverse channel data transfer is performed, the interface phase changes to the idle phase. At that time, there is no available data on the printer.
 - Reverse idle phase: When this signal is set to high according to the low pulse of the PtrClk signal, the host enters the reverse data transfer phase again. If this signal is set to high when the IEEE1284 Active signal is low, the IEEE1284 idle phase stops, and the interface enters the Compatibility mode.
- ⑥ nDataAvail (Printer → Host)
 - Reverse data transfer phase: When the signal is low, it indicates the printer has data to be sent to the host. And it is used for sending data bits 0 and 4.
 - Reverse idle phase: It is used for indicating that the data is available.

ECP mode

- ① Data 1 ~ 8 (Printer ← → Host)
 - Input/output data signals for the 1st to 8th bits.
 - Logic 1 is “High” level.
- ② HostClk (Printer ← Host)
 - This signal is used with the PeriphAck signal for transferring data information or address information from the host to peripheral equipment when a closed loop and handshake are executed.
- ③ PeriphAck (Printer → Host)
 - Peripheral equipment controls the forward data transfer using this signal. This signal also provides the 9th data bit which is used for determining whether or not command information or data information is included in the reverse data signal.
- ④ PeriphClk (Printer → Host)
 - This signal is used with the HostAck signal for transferring data information or address information from peripheral equipment to the host when a closed loop and handshake are executed.
- ⑤ nReverseRequest (Printer ← Host)
 - The host makes this signal LOW to change channels to the reverse direction.
 - In the ECP mode, only when this signal is LOW and the IEEE1284Active is HIGH, peripheral equipment can activate the bidirectional data signal.
- ⑥ XFlag (Printer → Host)
 -
- ⑦ nPeriphRequest (Printer → Host)
 - In the ECP mode, peripheral equipment can make this signal LOW for requesting communications with the host. The request is just only a “Hint” for the host. The host ultimately controls the transfer direction. This signal provides the peer-to-peer communication mechanism. This signal is usually used for generating an interrupt to the host. This signal takes effect in both directions forward and reverse.
- ⑧ nAckReverse (Printer → Host)
 - Peripheral equipment makes this signal LOW, and returns an ACK to the nReverseRequest signal. The host is dependent on the nAckReverse signal to determine the timing when the host is allowed to activate the data signal.
- ⑨ +5 V
 - This is not a signal but a +5 V power supply voltage.
 - The maximum current of 500 mA can be taken out.
- ⑩ IEEE1284Active (Printer ← Host)
 -
- ⑪ HostAck (Printer ← Host)
 - The host activates this signal to control the reverse data transfer. This signal is used with the PeriphClk signal, when an interlocked handshake is performed. This signal also provides the 9th data bit which is used for determining whether or not command information or data information is included in the forward data signal.

(11) Timing Chart

① When receiving normal data:

For the Compatibility mode, one of two types of timing for BUSY-ACK can be selected.

a) Timing 1 (Default)

●The USB board has not been installed.

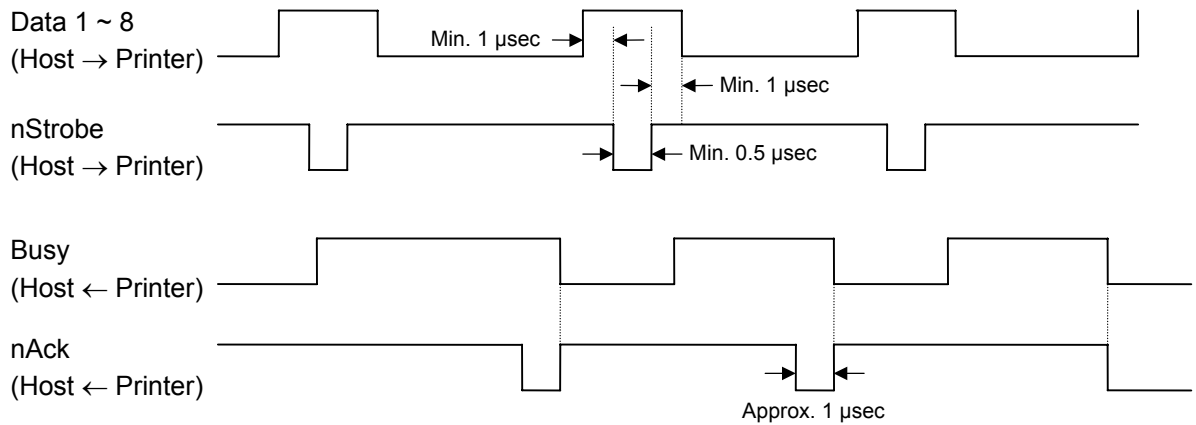

●The USB board has been installed.

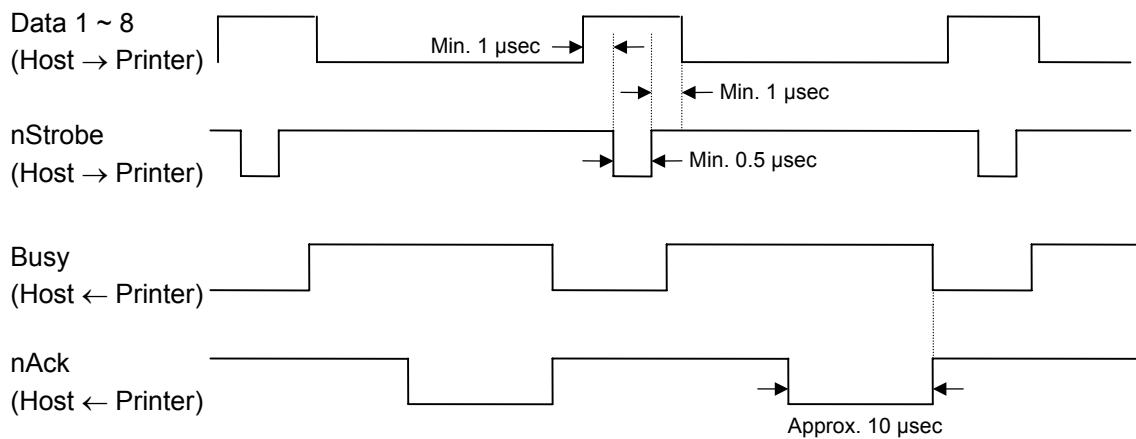

b) Timing 2

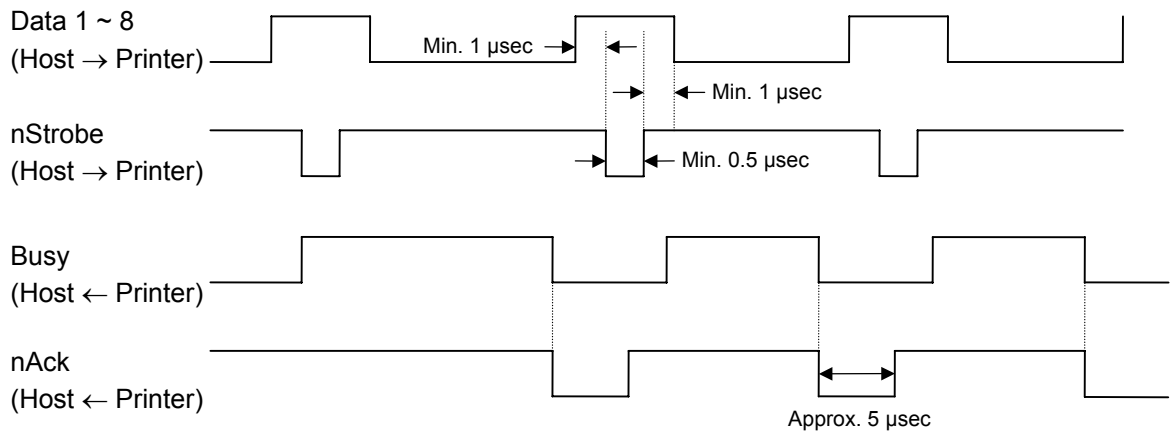

- ② Receiving data in the Compatibility mode when the blank positions in the receive buffer are 512 bytes or less:
- When the blank positions in the receive buffer become 512 bytes or less, the printer stores all of the already received data in the receive buffer, continues to be in a Busy state (Busy signal at “High” level) for 10 seconds to extend the data read interval when data is set from the host, then reads the data 10 seconds later.
 - If the blank positions becomes 513 bytes or more while waiting for reading data, the printer will receive the data with the normal data receive timing.
 - When there are no blank positions in the receive buffer, the printer stops reading data. Then, it continues to be in a Busy state (Busy signal at “High” level) until there are blank positions in the receive buffer when data is set from the host.

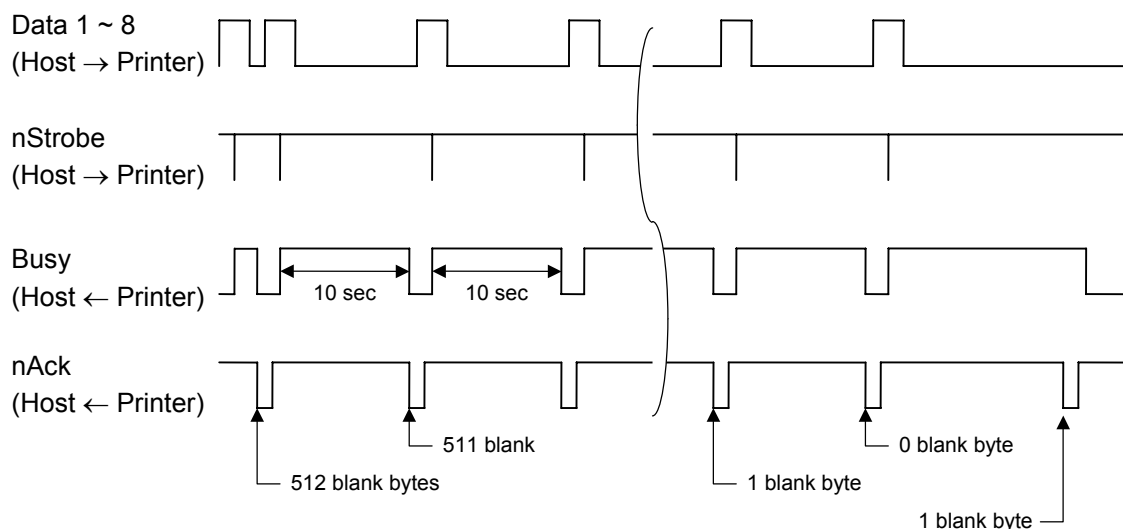

(12) Relationship between Printer Setting and PC Setting and Their Operation Modes

Printer setting \ Host setting	Windows95/98/Me		WindowsNT4.0		Windows2000/XP	
	Compatibility	ECP	Compatibility	ECP	Compatibility	ECP
Compatibility mode (SPP)	SPP	SPP	SPP	SPP	SPP	SPP
ECP mode (ECP)	SPP	ECP	SPP	SPP	SPP	SPP

- * When the Compatibility mode is selected for the printer setting, the printer does not respond to the ECP negotiation from the host.
- * When the ECP mode is selected for the printer setting, the Busy signal does not become HIGH even if an error occurs.
- * SPP mode operations include support for the Nibble mode.
- * When SPP mode is selected for the printer setting, the printer returns 13 bytes of status (described at the top of the next page) to the Nibble mode negotiation immediately after [ESC] WS [LF] [NUL] is received. The printer returns 23 bytes of status with the receive buffer free space information (described in (13) on the next page) to the Nibble mode negotiation immediately after [ESC] WB [LF] [NUL] is received,
- * When ECP mode is selected for the printer setting, the printer returns 13 bytes of status, (described at the top of the next page) to the Nibble mode negotiation or the ECP mode reverse request immediately after [ESC] WS [LF] [NUL] is received. The printer returns 23 bytes of status with the receive buffer free space information (described in (13) on the next page) to the Nibble mode negotiation or the ECP mode reverse request immediately after [ESC] WB [LF] [NUL] is received.

Status to be returned immediately after [ESC] WS [LF] [NUL] is received (13 bytes):

SOX	STX	Status			Remaining count				ETX	EOT	CR	LF
01H	02H	3XH	3XH	3XH	3XH	3XH	3XH	3XH	03H	04H	0DH	0AH

(13) Status with the receive buffer free space information

The printer should return a status with the receive buffer free space information to the Nibble mode negotiation or the ECP reverse request immediately after [ESC] WB [LF] [NUL] is received, as described blow.

Status to be returned immediately after [ESC] WB [LF] [NUL] is sent (23 bytes):

SOH	01H	Indicates the top of the status block
STX	02H	
Status	3XH	Printer status
	3XH	* For details, see section 9.1.1 "STATUS FORMAT".
Status type	33H	Indicates that the status includes the receive buffer free space information.
Remaining count	3XH	Remaining issue count
	3XH	* For details, see section 9.1.1 "STATUS FORMAT".
	3XH	
	3XH	
Length	3XH	Total number of bytes of this status block.
	3XH	
Free space of receive buffer	3XH	Free space of the receive buffer
	3XH	"0000" (0 Kbyte) to "99999" (99999 Kbytes)
	3XH	However, the maximum value should be the receive buffer capacity.
	3XH	
Receive buffer capacity	3XH	Receive buffer capacity
	3XH	"00000" (0 Kbyte) to "99999" (99999 Kbytes)
	3XH	However, the maximum value differs depending on the models.
	3XH	
CR	0DH	Indicates the end of the status block.
LF	0AH	

3.3 USB INTERFACE

- (1) Standard: Conforming to USB Standard Rev. 1.1
- (2) Data Transfer Type: Control transfer, Bulk transfer
- (3) Transfer Rate: Full speed (12 Mbps)
- (4) Transfer Control Method: Same as the transfer control method described in “(13) Data transfer in ECP mode” of section 3.2 “PARALLEL INTERFACE”

3.4 NETWORK INTERFACE

- (1) Configuration
 - ① PCMCIA board + LAN card
 - ② 100BASE LAN board
 - ③ PCMCIA board + Wireless LAN card
- (2) Protocol: TCP/IP
- (3) Network Specifications
 - ① LPR server function
 - ② WEB printer function
 - ③ Socket communication function
 - ④ FTP server function
 - ⑤ Mail transmission/reception function

* For more details on the network, refer to the Network Specification (TAA-1401).

4. KEY OPERATION FUNCTIONS

4.1 SYSTEM MODE FUNCTIONS

The system mode has the following functions for the printer self-test and setting various parameters. For details, refer to Key Operation Specification (TAA-1379).

(1) Self-test

- Maintenance counter/various parameters printouts
- Automatic self-test
- Head broken dots check

(2) Various parameters settings

- Character code selection
- Selection of font 0
- RS-232C communication speed
- RS-232C data length
- RS-232C stop bit length
- RS-232C parity
- RS-232C transmission control
- Language for LCD messages
- Forward feed standby
- Forward feed standby action
- Head-up operation in cut issue mode or the use of the rewinder in batch issue mode
- Installed solenoid type setting
- Use of ribbon saving system
- Control code
- Peel-off wait status selection
- [FEED] key function
- Kanji code selection
- Euro code setting
- Automatic head broken dots check
- Centronics ACK/BUSY timing setting
- Web printer function setting
- Reset process when the nInIt signal is ON
- Ribbon near end detection setting
- Expansion I/O operation mode
- Centronics operation mode
- Plug-and-play operation mode
- Label end/ribbon end process setting
- Pre-peel-off process setting
- Back feed speed setting
- MaxiCode specification setting
- Print head type setting
- System mode password operation setting
- XML specification setting (supported by V4.4A or greater)

- (3) Various parameters settings
 - Feed fine adjustment
 - Cut (strip) position fine adjustment
 - Back feed fine adjustment
 - X-coordinate fine adjustment
 - Print density fine adjustment (Thermal transfer print mode)
 - Print density fine adjustment (Direct thermal print mode)
 - Ribbon motor drive voltage fine adjustment (Rewind)
 - Ribbon motor drive voltage fine adjustment (Back tension)
 - Reflective sensor manual threshold fine adjustment
 - Transmissive sensor manual threshold fine adjustment
- (4) Test print
 - Operation conditions setting
 - 1-dot slant line printout
 - 3-dot slant line printout
 - Character printout
 - Bar code printout
 - Non-printing
 - Line printout for the assembly process
 - Automatic printout for the assembly process (Transmissive sensor)
 - Automatic printout for the assembly process (Reflective sensor)
- (5) Sensor display/adjustment
 - Thermal head temperature sensor display
 - Open-air temperature sensor display
 - Heat sink sensor display
 - Reflective sensor display/adjustment
 - Transmissive sensor display/adjustment
 - Reflective sensor adjustment value setting (without paper)
 - Transmissive sensor adjustment value setting (without paper)
 - Ribbon end sensor display/adjustment
- (6) RAM clear
 - Maintenance counter clear
 - Parameter clear
- (7) IP address setting
 - Printer IP address
 - Gateway IP address
 - Subnet mask
 - Socket communication port
 - DHCP setting
 - DHCP client ID setting
- (8) BASIC setting
 - BASIC setting
 - BASIC file browser
 - BASIC trace setting

(9) RFID setting

- RFID module type selection
- RFID tag type selection
- RFID error tag detection
- Max. number of RFID issue retries
- Max. number of RFID read retries
- RFID read retry time-out
- Max. number of RFID write retries
- RFID write retry time-out
- RFID adjustment for retry
- RFID wireless power level setting
- RFID AGC threshold setting
- RFID channel setting

(10) Initial values after RAM clear

- Initial values after maintenance counter clear

Parameter	Initial Value
Label distance covered	0 km
Printed distance	0 km
Cut count	0
Head up/down count	0
Ribbon motor drive time	0 hour
Head-up solenoid drive time	0 hour
RS-232C hardware error count	0
System error count	0
Momentary power interruption count	0

- Initial values after parameter clear

Parameter	Initial Value
Feed fine adjustment (PC)	0 mm
Cut position (or strip position) fine adjustment (PC)	0 mm
Back feed fine adjustment (PC)	0 mm
Print density fine adjustment (Thermal transfer print mode) (PC)	0
Print density fine adjustment (Direct thermal print mode) (PC)	0
Ribbon motor drive voltage fine adjustment (Rewind) (PC)	0
Ribbon motor drive voltage fine adjustment (Back tension) (PC)	0
Feed fine adjustment (Key)	0 mm
Cut position (or strip position) fine adjustment (Key)	0 mm
Back feed fine adjustment (Key)	0 mm
Print density fine adjustment (Thermal transfer print mode) (Key)	0
Print density fine adjustment (Direct thermal print mode) (Key)	0
Ribbon motor drive voltage fine adjustment	0

Parameter		Initial Value
(Rewind) (Key)		
Ribbon motor drive voltage fine adjustment (Back tension) (Key)		0
X-coordinate fine adjustment (Key)		0 mm
Transmissive sensor manual threshold fine adjustment value		1.4 V
Reflective sensor manual threshold fine adjustment value		1.0 V
Type of character code		PC-850
Font of 0		"0" (without slash mark)
Communication speed		9600 bps
Data length	QP type	8 bits
	QQ type	8 bits
	CN type	8 bits
Stop bit length		1 bit
Parity	QP type	NONE
	QQ type	NONE
	CN type	NONE
Flow control	QP type	XON/XOFF + READY/BUSY (DTR) protocol: (XON output when the power is on, XOFF output when the power is off)
	QQ type	READY/BUSY (DTR) protocol
	CN type	XON/XOFF + READY/BUSY (DTR) protocol: (XON output when the power is on, XOFF output when the power is off)
Language for LCD messages	QP type	English
	QQ type	English
	CN type	English
Forward feed standby after an issue		OFF
Forward feed standby action		MODE 1
Head-up operation in cut issue mode, or use of the rewinder		OFF (Head-up operation is not operated./ the rewinder is not used.)
Installed solenoid type setting		TYPE 2 (TDS-16A: Stronger pull force type)
Use of ribbon saving system	B-SX4T	OFF
	B-SX5T	ON (When the head lever position is "TAG".)
Type of control code		Auto
Peel-off wait status selection		OFF
[FEED] key function		FEED (One label is fed.)
Kanji code		TYPE1
Euro code		B0H
Automatic head broken dots check		OFF
Centronics ACK/BUSY timing setting		TYPE 1
Web printer function		OFF
Reset process when the nInit signal is ON		ON
Ribbon near end detection setting		OFF
Expansion I/O operation mode		TYPE1
Centronics operation mode		SPP
Plug-and-play operation mode		OFF
Label end/ribbon end process setting		TYPE1

Parameter		Initial Value
Pre-peel-off process setting		OFF
Back feed speed		3"/sec
MaxiCode specification setting		TYPE1
Print head type setting	B-SX4	V2 type: TPH104R7
	B-SX5	V2 type: TPH128R5
Status response		ON
Label pitch		76.2 mm
Effective print length		74.2 mm
Effective print width	B-SX4	104.0 mm
	B-SX5	128.0 mm
Print method		Thermal transfer print mode
Type of sensor		Transmissive sensor
Feed speed	B-SX4	6"/sec
	B-SX5	5"/sec
Issue mode		Batch
PC save automatic call		ON Save No. on the CPU board (ID) 01
BASIC interpreter setting		OFF
BASIC interpreter trace setting		OFF
DHCP setting		OFF
RFID module type selection		None
RFID tag type selection		None
RFID error tag detection		None
Max. number of RFID issue retries		3
Max. number of RFID read retries		5
RFID read retry time-out		4.0 sec.
Max. number of RFID write retries		5
RFID write retry time-out		2.0 sec.
RFID adjustment for retry		Invalid: 0 mm
RFID wireless power level setting		B-9704-RFID-U1: 251 B-SX704-RFID-U2: 20 B-9704-RFID-U1-EU-R: 50
RFID AGC threshold setting		0
RFID channel setting		AUTO
Number of successful RFID write		0
Number of failure in RFID write		0
System mode password operation setting		OFF
LAN enable/disable setting		OFF
XML specification setting		STD

- The total label distance covered, sensor adjustment values (system mode <5>), IP address setting, socket communication number setting, and data of flash memory (flash memory card, ATA card, and flash ROM on the CPU board) are not cleared by RAM clear.
- Number of successful RFID write and number of failure in RFID write are not cleared by RAM clear.
- System password setting cannot be cleared by RAM clear.

4.2 ONLINE MODE FUNCTIONS

The online mode provides the following functions for issuing labels and setting the threshold.
(For details, refer to Key Operation Specification (TAA-1379).)

- (1) Issuing labels (by external equipment interface commands)
- (2) Paper feed (by the [FEED] key)
- (3) Pause (Halts issuing labels by the [PAUSE] key)
- (4) Restart (Reissues labels by the [RESTART] key after halting issuing labels or after the occurrence of an error.)
- (5) Reset (Enters an usual initial state which is obtained after the power is turned on, using the [RESTART] key.)
- (6) Error indication
- (7) Threshold setting
- (8) Various parameters settings
- (9) Various fine adjustments setting
- (10) Dumping of receive buffer

4.3 DOWNLOAD MODE SETTING FUNCTION

When the power is turned on by pressing the [FEED], [PAUSE], and [RESTART] keys at the same time, the printer enters the download mode. Therefore, the usual operations cannot be performed.
For details, refer to the Key Operation Specification (TAA-1379).

5. TRANSMISSION SEQUENCE

This section describes the outline of the transmission sequence.

5.1 INITIALIZATION

Writable characters, logo, and PC interface commands must be stored before the label issue operation.

(1) Storing writable characters and logo

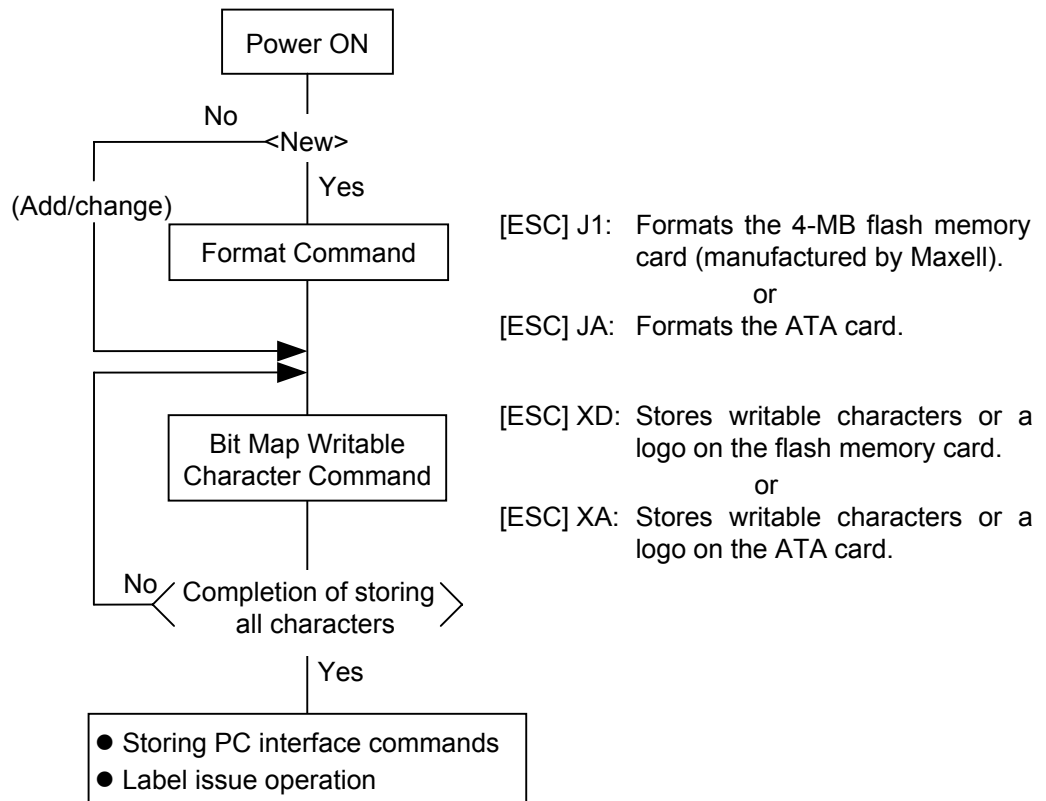

NOTES: (1) *The storage of writable characters or logos is only performed if it is required.*

(2) *When the flash memory card is used, and the Format Command is not sent before storing already stored writable characters or logos, memory will be taken up with every such storing.*

(3) *When the flash memory card is used, and another operation (storing PC interface commands or label issue operation) is performed after storing writable characters or logos, the image buffer will be cleared automatically.*

(4) *If another storing operation does not take place after storing writable characters or logos, the printer automatically enters the online mode (label issue operation) after about 10 seconds. In this case, when the flash memory card is used, the image buffer will be cleared automatically.*

(2) Storing PC interface commands

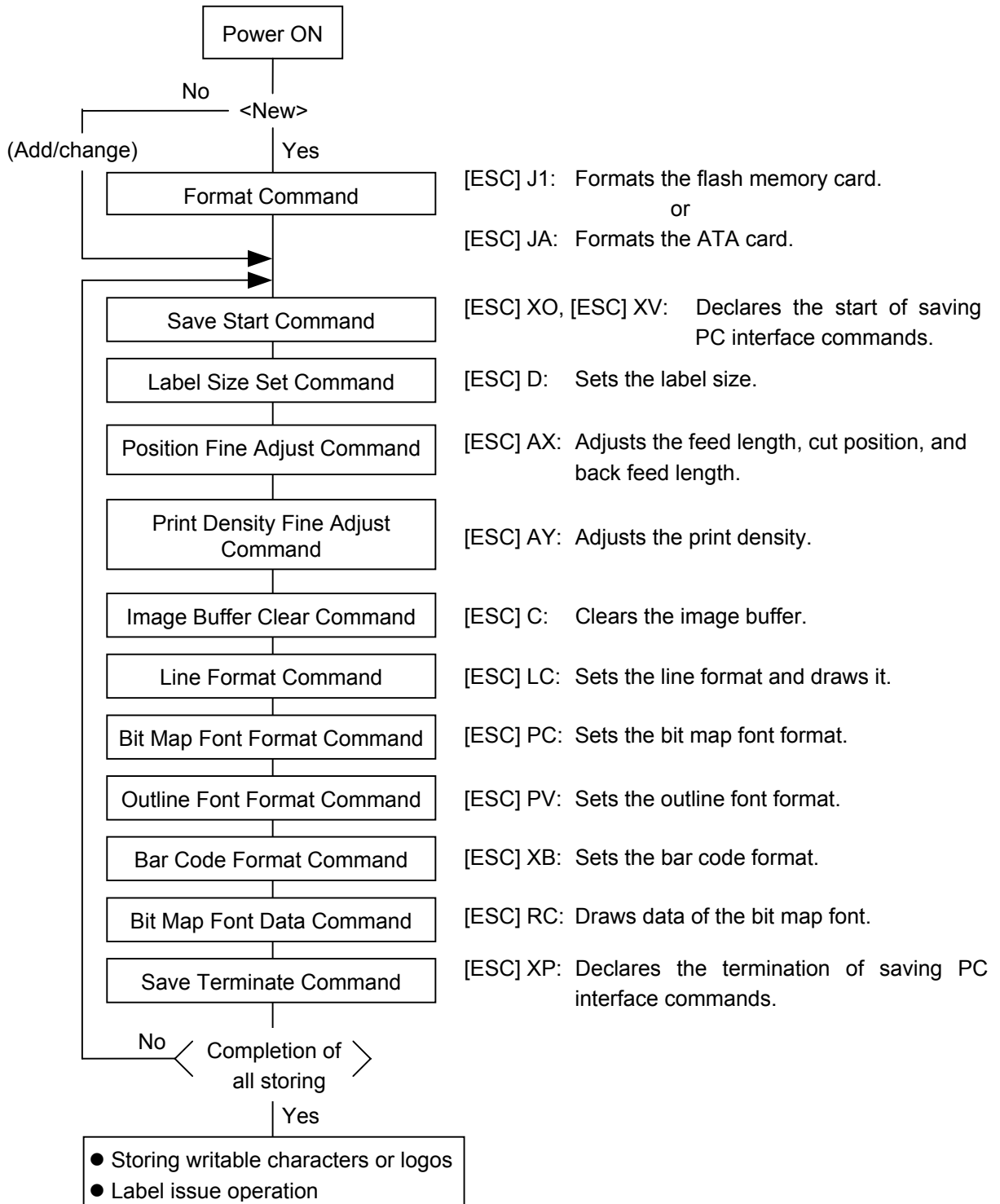

- NOTES:** (1) The storage of PC commands is only performed if it is required.
 (2) When the flash memory card is used, and the Format Command is not sent before storing already stored PC interface commands, memory will be taken up with every such storing.
 (3) When the flash memory card is used, and another operation (storing writable characters or logos, label issue operation) is performed after storing PC interface commands, the image buffer will be cleared automatically.
 (4) Select commands to be stored as the occasion demands.
 (5) If another storing operation does not take place after storing PC interface commands, the printer enters the online mode (label issue operation) after about 10 seconds. In this case, when the flash memory card is used, the image buffer will be cleared automatically.

5.2 LABEL ISSUE OPERATION

An example of the label issue operation is described below.

(1) Where the Saved Data Call Command is not used:

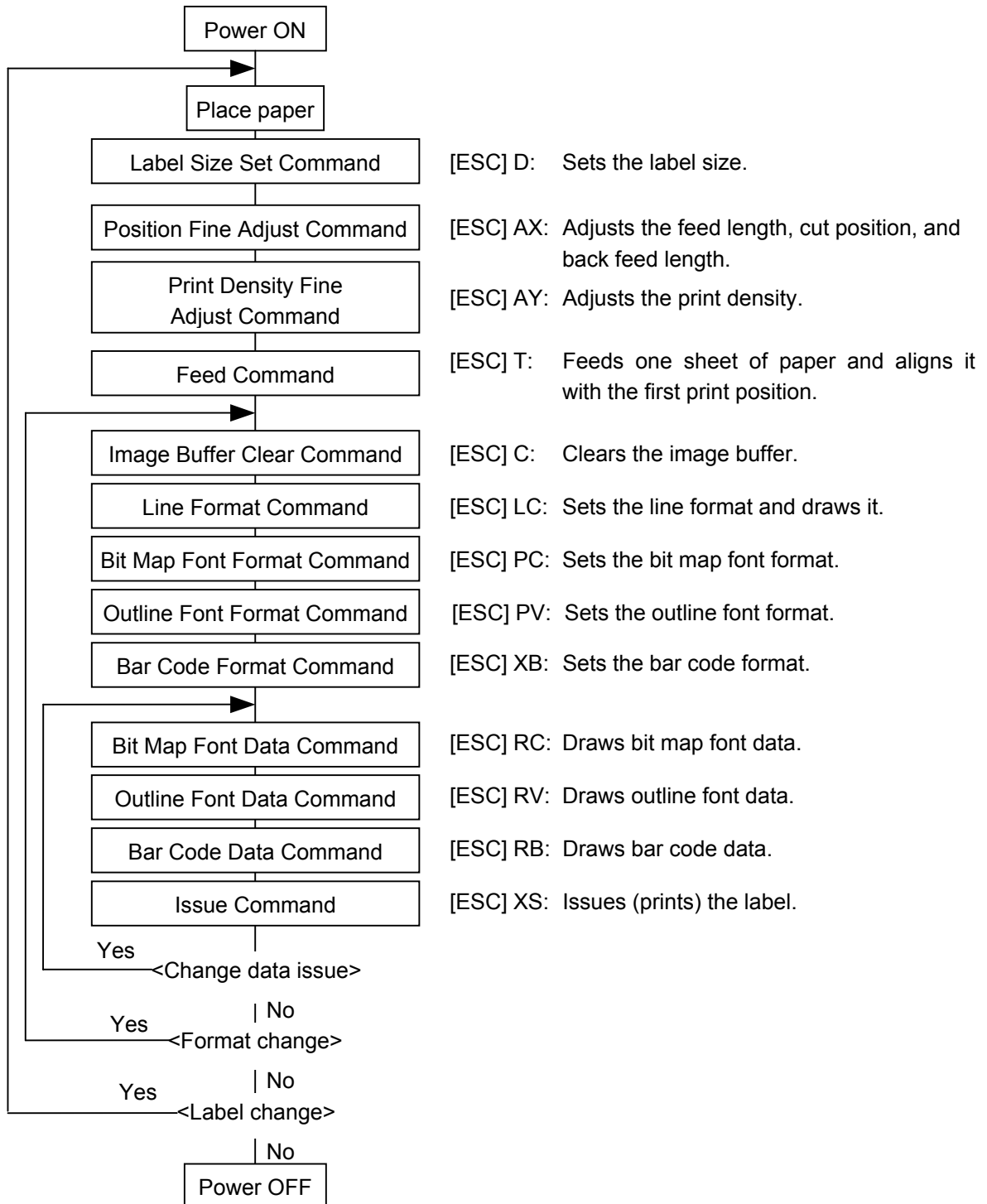

NOTES: (1) When placing new paper, the Label Size Set Command and the Feed Command must always be sent. When using the same paper after the power is turned off and on, the Label Size Set Command and the Feed Command may be omitted.

(2) After the power is turned off and on, the Bit Map Font Format Command, the Outline Font Format Command, and the Bar Code Format Command should be sent as occasion demands because they are not protected in memory.

(2) Where the Saved Data Call Command is used:

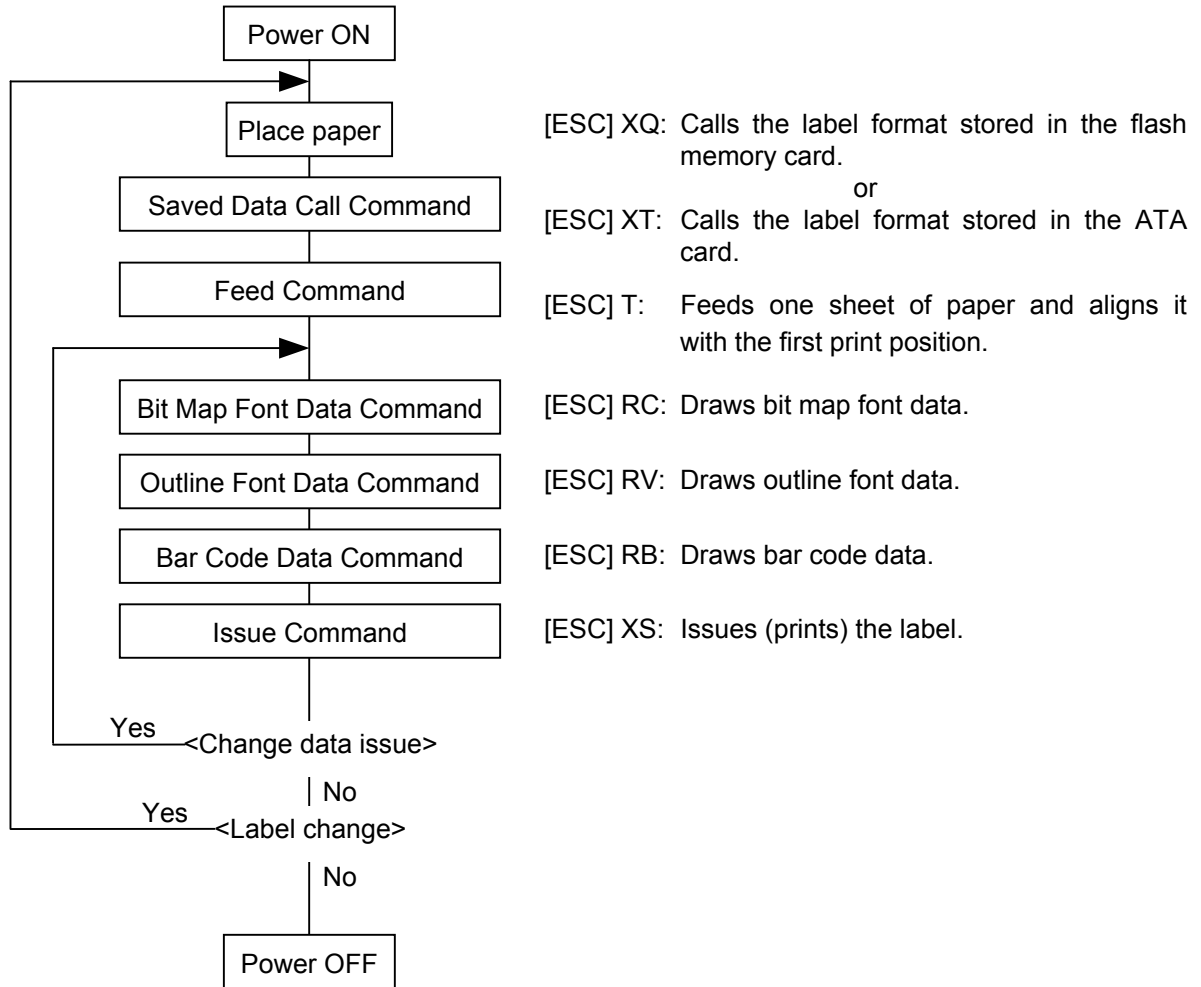

- NOTES:** (1) When placing new paper, the Feed Command must always be sent. When using the same paper after the power is turned off and on, the Feed Command may be omitted.
- (2) If the option for “automatic call at power on” for the Saved Data Call Command has previously been selected, the Saved Data Call Command may be omitted after the power is turned off and on.

(3) Where the XML data is used:

Print data in XML format can be sent to the printer.

* For details, refer to the XML Data Print Specification (TAA-1320).

6. INTERFACE COMMANDS

6.1 OUTLINE OF COMMANDS

(1) Format of Interface command

ESC	Command & Data	LF	NUL
-----	----------------	----	-----

- The length from [ESC] to [LF] [NUL] must be as specified by each command.
- There are the following three kinds of control codes:
 - ① ESC (1BH), LF (0AH), NUL (00H)
 - ② { (7BH), | (7CH), } (7DH)
 - ③ Code set in the system mode

(2) How to use reference

Function Describes the outline of the function of the command.

Format Shows the format of the command.

The format designation method should conform to the following rules:

- Each set of small letters (such as aa, bbbb) indicates a parameter item.
- An item enclosed in parentheses may be omitted.
- “...” indicates the repetition of an item.
- Brackets and parentheses are used only in coding, and must not be transmitted in practice.
- Other symbols must always be inserted at designated positions before being transmitted.

Term Explains the term(s) used in the format.
 * “0 to 999” described in the entry range indicates that up to 3-digit variable-length entry is allowed. (Entry of “001” or “009” is also possible.) “000 to 999” indicates that the entry must be fixed as 3 digits.

Explanation Explains the command in detail.

Note Supplementary explanation of the command.

Refer to Related commands

Examples Explains the command examples.

[ESC] T20C30 [LF] [NUL]

The above corresponds to the transfer of the following:

1B 54 32 30 43 33 30 0A 00
 [ESC] T 2 0 C 3 0 [LF] [NUL]

(3) Precautions

The commands and parameters described in this specification must always be used. If any command or parameter other than those covered in this specification are used, the printer's operation will not be guaranteed. The commands must be used in the online mode. If any command is transmitted in the system mode, the printer will not operate. However, only the Reset Command can be used.

6.2 LIST OF COMMANDS

(1) Commands related to setting	
Label Size Set Command	[ESC] D..... 33
(2) Commands related to fine adjustment	
Position Fine Adjust Command	[ESC] AX..... 39
Print Density Fine Adjust Command	[ESC] AY..... 47
Ribbon Motor Drive Voltage Fine Adjust Command	[ESC] RM..... 48
(3) Commands related to clear	
Image Buffer Clear Command	[ESC] C..... 49
Clear Area Command	[ESC] XR 50
(4) Commands related to drawing format setting	
Line Format Command	[ESC] LC..... 52
Bit Map Font Format Command	[ESC] PC 56
Outline Font Format Command	[ESC] PV..... 73
Bar Code Format Command	[ESC] XB..... 90
(5) Commands related to print data	
Bit Map Font Data Command	[ESC] RC 136
Outline Font Data Command	[ESC] RV 141
Bar Code Data Command	[ESC] RB 144
(6) Commands related to issue and feed	
Issue Command	[ESC] XS..... 157
Feed Command	[ESC] T 173
Eject Command	[ESC] IB..... 180
Forward/Reverse Feed Command	[ESC] U1, [ESC] U2..... 182
(7) Commands related to writable characters	
Storage Area Allocate Command	[ESC] XF..... 184
Flash Memory Format Command	[ESC] J1..... 186
ATA Card Format Command	[ESC] JA 187
2-byte Writable Character Code Range Command	[ESC] XE..... 188
Bit Map Writable Character Command (for flash memory)	[ESC] XD 189
Bit Map Writable Character Command (for ATA card)	[ESC] XA..... 190
(8) Commands related to graphics	
Graphic Command	[ESC] SG 201
(9) Commands related to PC command saving	
Flash Memory Format Command	[ESC] J1..... 186
ATA Card Format Command	[ESC] JA 187
Save Start Command (for flash memory)	[ESC] XO 209
Save Start Command (for ATA card)	[ESC] XV..... 210
Save Terminate Command	[ESC] XP..... 211
Saved Data Call Command (for flash memory)	[ESC] XQ 212
Saved Data Call Command (for ATA card)	[ESC] XT 213

(10)	Commands related to check	
	Head Broken Dots Check Command	[ESC] HD 214
(11)	Commands related to display	
	Message Display Command	[ESC] XJ 215
(12)	Commands related to control	
	Reset Command	[ESC] WR 217
	Batch Reset Command	[ESC] Z0 238
(13)	Commands related to status	
	Status Request Command	[ESC] WS..... 218
	Receive Buffer Free Space Request Command	[ESC] WB..... 219
	Version Information Acquire Command	[ESC] WV..... 220
	ATA Card Information Acquire Command	[ESC] WI..... 221
	ATA Card Writable Character Information Acquire Command	[ESC] WG 223
	Printer Option Status Acquire Command	[ESC] WN 224
(14)	Commands related to TCP/IP setting	
	IP Address Set Command	[ESC] IP 225
	Socket Communication Port Set Command	[ESC] IS 226
	DHCP Function Set Command	[ESC] IH..... 227
(15)	Commands related to internal serial interface	
	Pass-through Command	[ESC] @002..... 228
	Internal Serial Interface Parameter Set Command	[ESC] IZ 229
(16)	Commands related to parameter setting	
	Parameter Set Command	[ESC] Z2;1 230
	Fine Adjustment Value Set Command	[ESC] Z2;2 234
	RFID Parameter Set Command	[ESC] Z2;3 236
(17)	Commands related to RFID	
	RFID Tag Position Adjustment Command	[ESC] @003..... 239
	RFID Tag Read Command	[ESC] WF 240
	RFID Void Pattern Print Command	[ESC] @006..... 243
	RFID Data Write Command	[ESC] @012..... 244

6.3 COMMANDS FOR CREATING APPLICATION

6.3.1 LABEL SIZE SET COMMAND

[ESC] D

Function	Sets the size of a label or tag.
Format	[ESC] Daaaa, bbbb, cccc (, dddd) [LF] [NUL]
Term	<p>aaaa: Pitch length of the label or tag 4 and 5 digits (in 0.1 mm units) 4 digits: 0100 (10.0 mm) to 9999 (999.9 mm) 5 digits: 00100 (10.0 mm) to 15000 (1500.0 mm)</p> <p>bbbb: Effective print width Fixed as 4 digits (in 0.1 mm units) B-SX4T: 0100 (10.0 mm) to 1040 (104.0 mm) B-SX5T: 0100 (10.0 mm) to 1280 (128.0 mm)</p> <p>cccc: Effective print length 4 and 5 digits (in 0.1 mm units) 4 digits: 0060 (6.0 mm) to 9999 (999.9 mm) 5 digits: 00060 (6.0 mm) to 14980 (1498.0 mm)</p> <p>dddd: Backing paper width (Omissible. If omitted, the initial value is the effective print width.) Fixed as 4 digits (in 0.1 mm units) B-SX4T: 0300 (30.0 mm) to 1120 (112.0 mm) B-SX5T: 0300 (30.0 mm) to 1400 (140.0 mm)</p>

Explanation

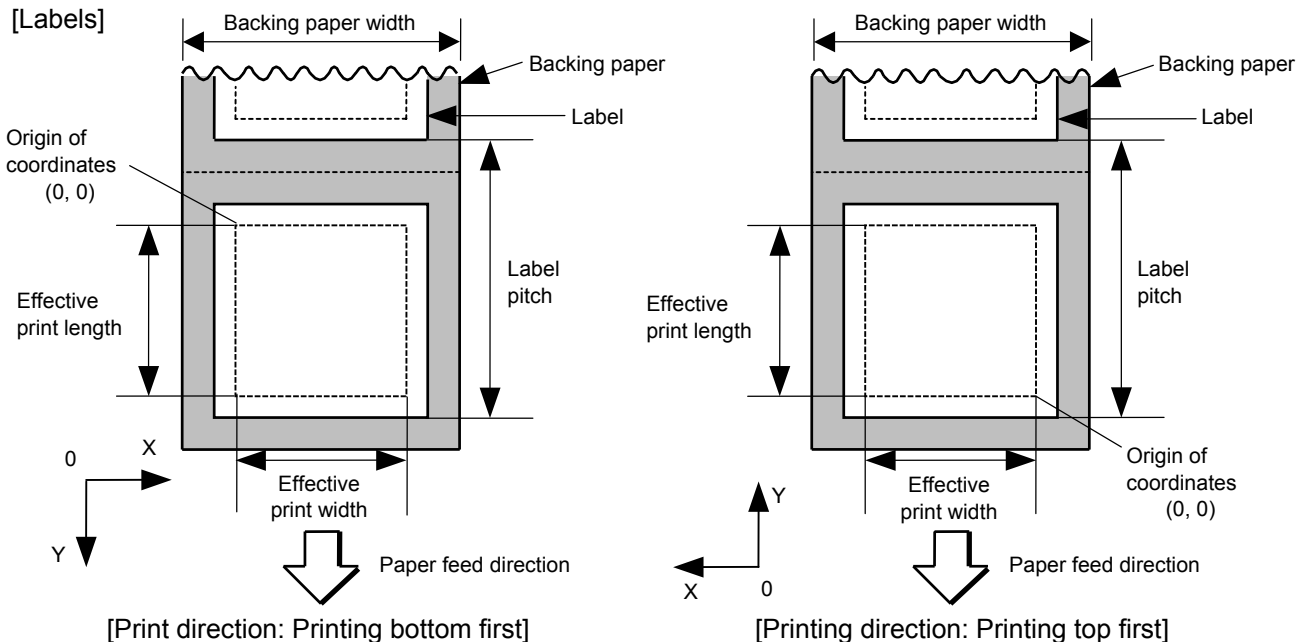

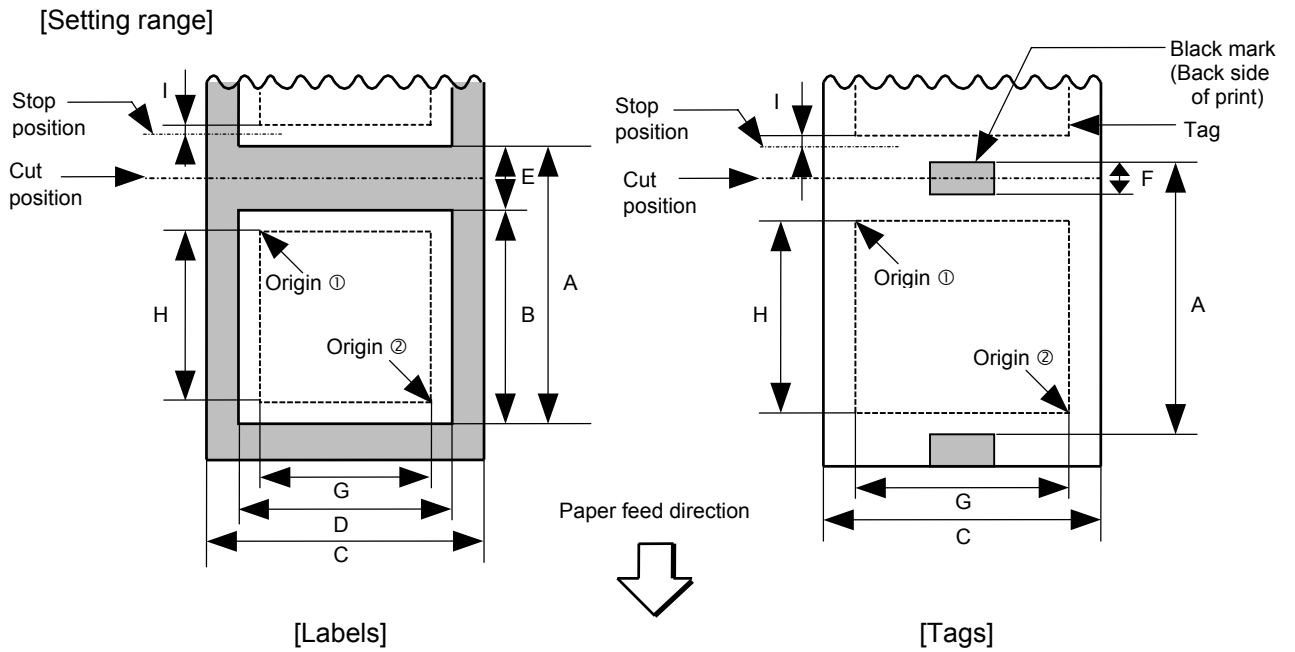
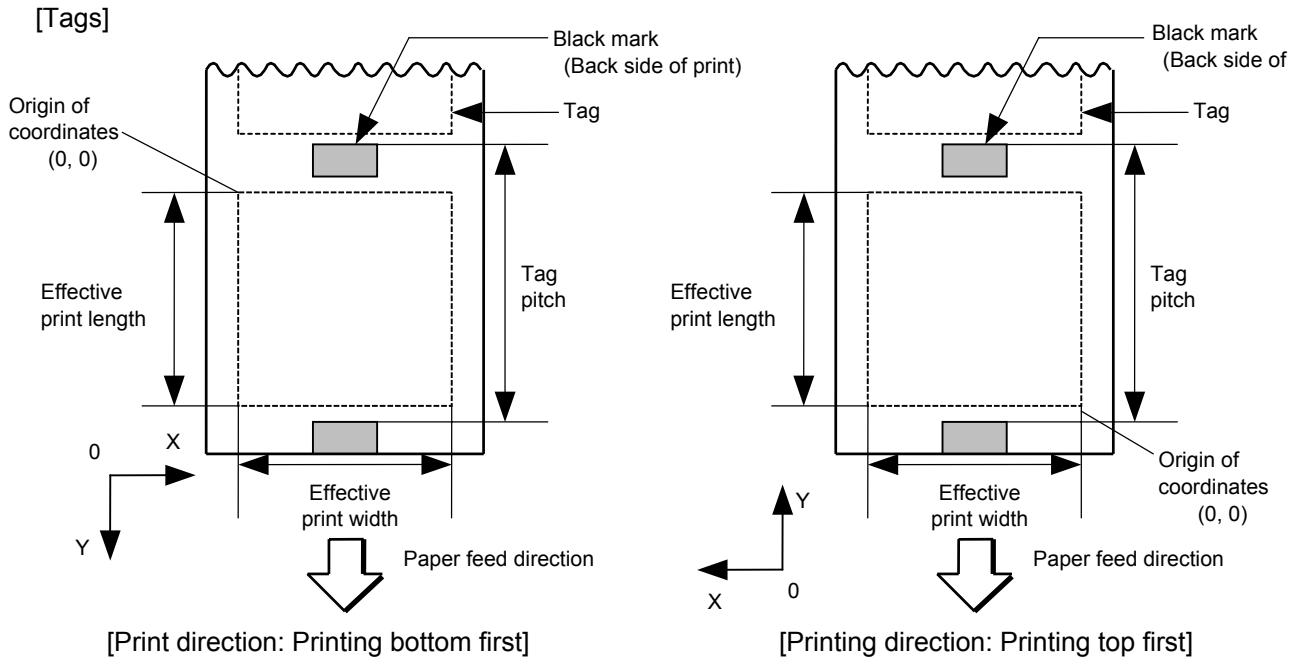

[mm]

Model Issue mode Item		B-SX4T					B-SX5T						
		Batch	Strip	Cut			Batch	Strip	Cut				
				Swing cutter	Rotary cutter				Swing cutter	Rotary cutter			
					Head-up operation not performed	Head-up operation performed				Head-up operation not performed	Head-up operation performed		
Thermal head dot density		8 dots/mm (203 dpi)					12.05 dots/mm (306 dpi)						
Thermal head width		104.0 mm					127.5 mm						
Range of values which can be set on the software													
A: Label pitch Tag pitch		Label	Min.	10.0	25.4	38.0	3 ips:	3 ips:	10.0	25.4	38.0	3 ips:	3 ips:
							94.0	38.0				5 ips:	5 ips:
							106.0	38.0				8 ips:	8 ips:
		10 ips: – (NOTE 1)	10 ips: – (NOTE 1)	113.0	38.0								
		Max.	1500.0					1500.0					
		Tag	Min.	10.0	–	25.4	3 ips: 30.0		10.0	–	25.4	3 ips: 30.0	
							6 ips: 30.0					5 ips: 30.0	
							10 ips: – (NOTE 1)					8 ips: 38.0	
				Max.	1500.0	–	1500.0					1500.0	–
B: Label length			Min.	8.0	23.4	25.0 (*3)	3 ips: (*1)	3 ips:	8.0	23.4	25.0 (*7)	3 ips: (*4)	3 ips:
							81.0	32.0				5 ips: (*5)	5 ips:
							6 ips: (*2)	6 ips:				89.0	32.0
		93.0	32.0	100.0	32.0								
		Max.	1498.0		1494.0			1498.0		1494.0			
C: Backing paper width Tag width		Min.	30.0	50.0	30.0			30.0	50.0	30.0			
		Max.	112.0					140.0		112.0			
D: Label width		Min.	27.0					27.0					
		Max.	109.0					137.0		109.0			
E: Label-to-label gap		Min.	2.0		6.0			2.0		6.0			
		Max.	20.0					20.0					
F: Black mark length		Min.	2.0					2.0					
		Max.	10.0					10.0					
G: Effective print width		Min.	10.0					10.0					
		Max.	104.0					128.0					
H: Effective print length		Label	Min.	6.0	21.4	23.0	3 ips:	3 ips:	6.0	21.4	23.0	3 ips:	3 ips:
							79.0	30.0				5 ips:	5 ips:
							6 ips:	6 ips:				87.0	30.0
		91.0	30.0	98.0	30.0								
		Max.	1496.0		1492.0			1496.0		1492.0			
		Tag	Min.	8.0	–	23.4	3 ips: 28.0		8.0	–	23.4	3 ips: 28.0	
							6 ips: 28.0					5 ips: 28.0	
							10 ips: – (NOTE 1)					8 ips: 36.0	
				Max.	1498.0	–	1498.0					1498.0	–
I: Slow up/ down interval		Slow-up	1.0					1.0					
		Slow-down	1.0					1.0					
Max. effective print length for on-the-fly issuing		749.0					749.0						

NOTE 1: The use of the rotary cutter at 10 ips is not supported for the B-SX4T.

B-SX4T:

- (*1): When a cut issue is performed at 3 ips by using the rotary cutter, label length B should be as follows:

$$\text{Label length } B \geq 91.0 \text{ mm} - \left(\frac{\text{Label-to-label gap}}{2} \right)$$

- (*2): When a cut issue is performed at 6 ips by using the rotary cutter, label length B should be as follows:

$$\text{Label length } B \geq 103.0 \text{ mm} - \left(\frac{\text{Label-to-label gap}}{2} \right)$$

- (*3): When a cut issue is performed by using the swing cutter, label length B should be as follows:

$$\text{Label length } B \geq 35.0 \text{ mm} - \left(\frac{\text{Label-to-label gap}}{2} \right)$$

B-SX5T:

- (*4): When a cut issue is performed at 3 ips by using the rotary cutter, label length B should be as follows:

$$\text{Label length } B \geq 91.0 \text{ mm} - \left(\frac{\text{Label-to-label gap}}{2} \right)$$

- (*5): When a cut issue is performed at 5 ips by using the rotary cutter, label length B should be as follows:

$$\text{Label length } B \geq 99.0 \text{ mm} - \left(\frac{\text{Label-to-label gap}}{2} \right)$$

- (*6): When a cut issue is performed at 8 ips by using the rotary cutter, label length B should be as follows:

$$\text{Label length } B \geq 110.0 \text{ mm} - \left(\frac{\text{Label-to-label gap}}{2} \right)$$

- (*7): When a cut issue is performed by using the swing cutter, label length B should be as follows:

$$\text{Label length } B \geq 35.0 \text{ mm} - \left(\frac{\text{Label-to-label gap}}{2} \right)$$

Notes

- (1) Before changing the label size or type of sensor, the Label Size Set Command must first be transmitted.
- (2) The Label Size Set Command is protected in memory (even if the power is turned off).
- (3) After sending the Label Size Set Command, one sheet of paper must be fed by the Feed Command ([ESC] T) and must be aligned with the first print position prior to printing.
- (4) The origin of drawing coordinates, print stop position (head position at stop), and cut position are determined according to the parameters of the Label Size Set Command as shown in the figure on the preceding page. For the print stop position in strip issue mode, refer to the section of the Position Fine Adjust Command. The effective print area is centered on the label/tag.
- (5) Printing cannot be performed in the slow up (1 mm) and slow down (1 mm) areas. Consequently, $[A: \text{Label pitch/Tag pitch}] - [H: \text{Effective print length}] \geq 2 \text{ mm}$ must be assumed.
- (6) The origin of drawing coordinates, print stop position (head position at stop), and cut position are adjustable by the Fine Adjust Commands and according to the fine adjustment settings in the system mode.
- (7) The tag rotation designation of the Issue Command ([ESC] XS) causes the origin of drawing coordinates to be origin ① in the case of “printing bottom first” and to be origin ② in the case of “printing top first”, as shown in the figure.
- (8) The parameters must be as shown in the figure and table. Any value or paper outside the range results in a failure of printing or an error.
- (9) Where an effective print length within “max. effective print length for on-the-fly” is specified, labels even each with different data can be printed continuously without stopping every label because printing and drawing of the next label are processed at the same time. [On-the-fly issue]
However, printing may stop every label depending on the quantity of drawing data. Also, if the ribbon saving is performed, the On-the-fly issue will not be performed regardless of the data quantity.
- (10) The setting for the backing paper width is used for the control of the backing paper rewind motor for a strip issue. Therefore, this setting is not effective for any mode other than strip issue mode.

Examples

(1) Labels

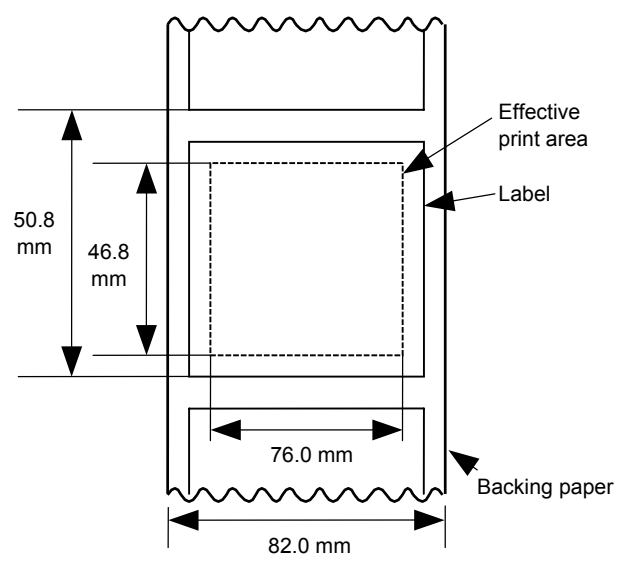

[ESC] D0508, 0760, 0468, 0820 [LF] [NUL]
[ESC] T20C30 [LF] [NUL]

(2) Tags

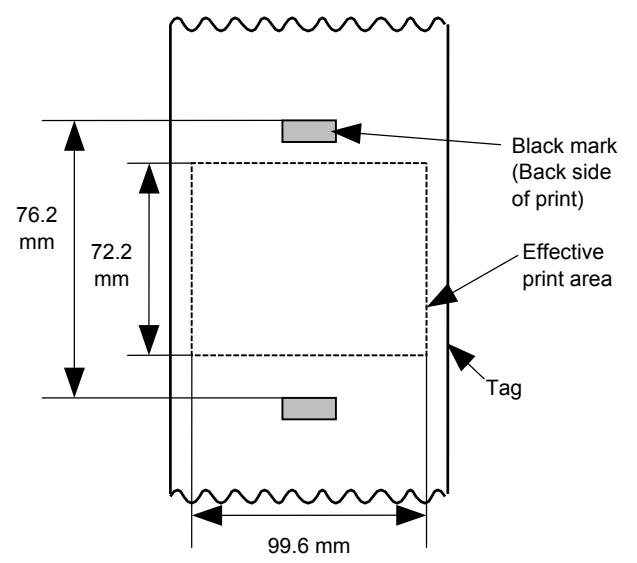

[ESC] D0762, 0996, 0722 [LF] [NUL]
[ESC] T10C30 [LF] [NUL]

6.3.2 POSITION FINE ADJUST COMMAND

[ESC] AX

Function	<p>① Adjusts the feed value so that the label will be shifted forward or backward from the automatically set first print start position.</p> <p>② Adjusts the cut position so that the label will be cut at a position shifted forward or backward from the automatically set cut position, or adjusts the strip position so that the label will be shifted forward or backward from the automatically set strip position.</p> <p>③ Adjusts the value for feeding the label back to the home position after cutting, or adjusts the value for feeding the label back to the home position after stripping.</p>
Format	[ESC] AX; abbb, cddd, eff [LF] [NUL]
Term	<p>a: Indicates the direction, forward or backward, in which a fine adjustment is to be made. +: Backward -: Forward</p> <p>bbb: Feed value to be finely adjusted. 000 to 500 (in 0.1 mm units)</p> <p>c: Indicates the direction, forward or backward, in which a cut position (or strip position) fine adjustment is to be made. +: Backward -: Forward</p> <p>ddd: Fine adjustment value for the cut position (or strip position). 000 to 500 (in 0.1 mm units)</p> <p>e: Indicates whether the back feed is to be increased or decreased. +: Increase -: Decrease</p> <p>ff: Back feed length fine adjustment value 00 to 99 (in 0.1 mm units)</p>

Explanation

[Feed Length Fine Adjustment] (To finely adjust the feed for shifting backward or forward)

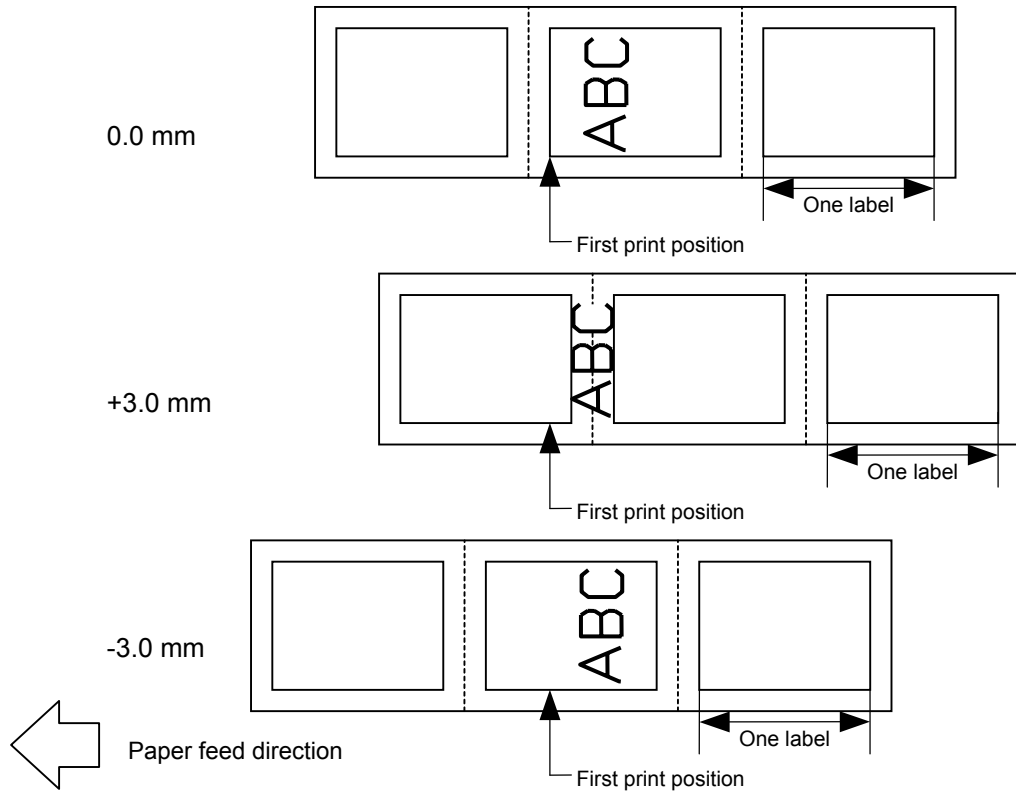

[Cut Position Fine Adjustment] (To finely adjust the cut position for shifting backward or forward)

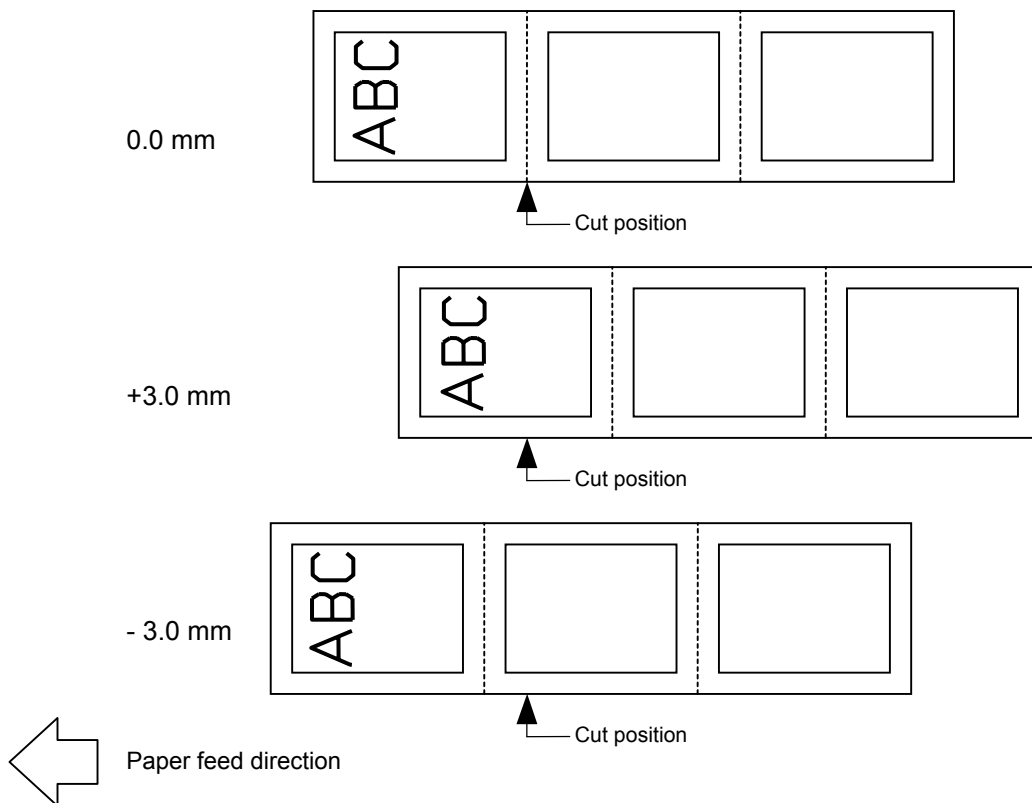

[Strip Position Fine Adjustment]

0.0 mm

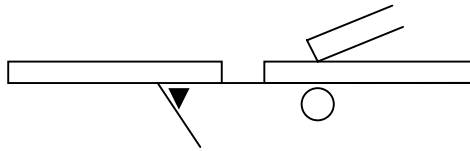

+3.0 mm

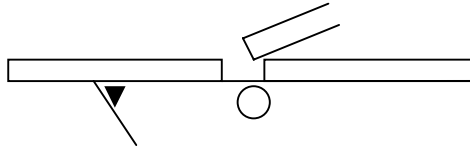

-3.0 mm

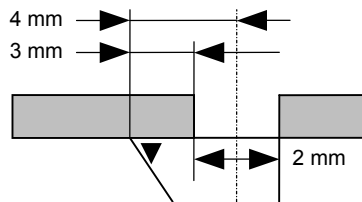
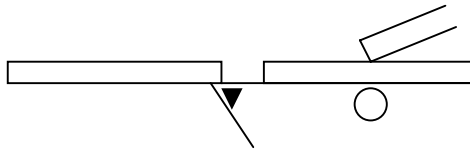

Printing in strip issue mode is stopped at the position where the distance from the middle point of the label-to-label gap to the end of the strip shaft is 4 mm, since the label-to-label gap is assumed to be 2 mm.

When the print stop position is not proper, the print stop position should be adjusted using the strip position fine adjust function. When the label-to-label gap is 5 mm or more, the effective print length should be set to the maximum (label pitch -2 mm). Then, the print stop position should be adjusted using the strip position fine adjust function.

[Back Feed Fine Adjustment] (To finely adjust the back feed for shifting backward or forward)

0.0 mm



First print position (home position after back feed)

+3.0 mm



First print position (home position after back feed)

-3.0 mm

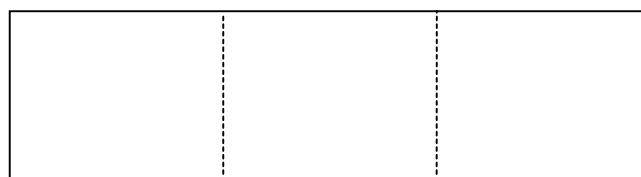

First print position (home position after back feed)

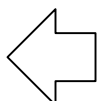

Paper feed direction

Notes

- (1) If the feed value fine adjustment, cut position (or strip position) fine adjustment or back feed value fine adjustment has been set in the system mode (key operation on the printer), the fine adjustment value will be the sum of the fine adjustment by this command and the fine adjustment in the system mode. The max. fine adjustment values are as follows. However, the max. feed fine adjustment value is limited within the label pitch.

Feed value fine adjustment.....±50.0 mm
 Cut position (or strip position) fine adjustment.....±50.0 mm
 Back feed value fine adjustment.....±9.9 mm

- (2) After changing the fine adjustment value by this command, one label must be fed by the Feed Command ([ESC] T) to adjust the first print position.
- (3) Each fine adjustment value is protected in memory (even if the power is turned off).
- (4) If a fine adjustment value is improper, printing will not be performed correctly.

(For example, if the back feed fine adjustment value is not set properly, the print positions without cutting and after cutting will be different from each other. If the label is fed back excessively, the paper will not be fed correctly during printing.
 In the strip issue mode, the print position may differ between the first label and the second label. The back feed fine adjustment is used to adjust the length so that the label is correctly fed back to the position placed before the forward feed is performed.

- (5) The cut position (or the strip position) fine adjustment and the back feed fine adjustment are effective only when the printer is in cut issue or strip issue mode.
- (6) Procedure for label having label pitch of less than 38 mm when the swing cutter is used:

The minimum label pitch of the label which can be cut in normal use is 38 mm. When a label having a label pitch of less than 38 mm is used (although it is out of specifications), the edge of the label is caught by the edge of the thermal head during a back feed to the home position after cutting the gap area between labels. Therefore, the label may not be fed back to the proper home position. By performing either method below, the problem will be solved.

[Method 1] Lift the head.

When the following conditions are all met, the cut operation is as follows.

Head lifted → Forward feed to the cut position → Head lowered → Cut →
 Head lifted → Reverse feed to the home position → Head lowered

Conditions: Issue Command, Feed Command, and Eject Command received.

Label pitch of 38.0 mm or less, cut performed, transmissive sensor designated, cut position fine adjustment of ±10.0 mm or less, and issue mode "C"

* The head is lifted/lowered only when the optional ribbon save module is attached and the use of the ribbon saving system is set to ON in the parameter setting. When the ribbon save module is not installed, use Method 2 since the head is not lifted/lowered.

- NOTES:** 1. *If the head is being lifted when the edge of the label which is being ejected passes the paper feed roller, the sensor may not be able to detect an error even if it occurs (a feed cannot be performed).*
2. *If the head-up solenoid temperature is high when a cut issue is about to be performed with the head lifted, the head may not be lifted.*

[Method 2] Adjust the cut position value.

When this procedure is used, one or more printed labels are left between the head and the cutter. Therefore, these labels should be removed by an issue or a label feed.

(a) Cut position fine adjustment value calculation

The cut position fine adjustment value can be calculated using the following method. If a back feed to the proper home position cannot be performed using this value, the cut position should be adjusted with any value.

$$\begin{aligned} \text{Cut position fine adjustment value} &= (\text{Number of labels left between head and cutter}) \times (\text{Label pitch}) \\ &= \left(\frac{32.8 \text{ mm}}{\text{Label pitch}} \right) \times (\text{Label pitch}) \end{aligned}$$

* Any decimal remainders are dropped.

Ex) Label pitch: 30.0 mm

$$\begin{aligned} \text{Cut position fine adjustment value} &= \left(\frac{32.8 \text{ mm}}{30.0 \text{ mm}} \right) \times (30.0 \text{ mm}) \\ &= 1 \times 30.0 \text{ mm} \\ &= +30.0 \text{ mm} \end{aligned}$$

(b) Operation example

Issue count: 2, Cut interval = 1

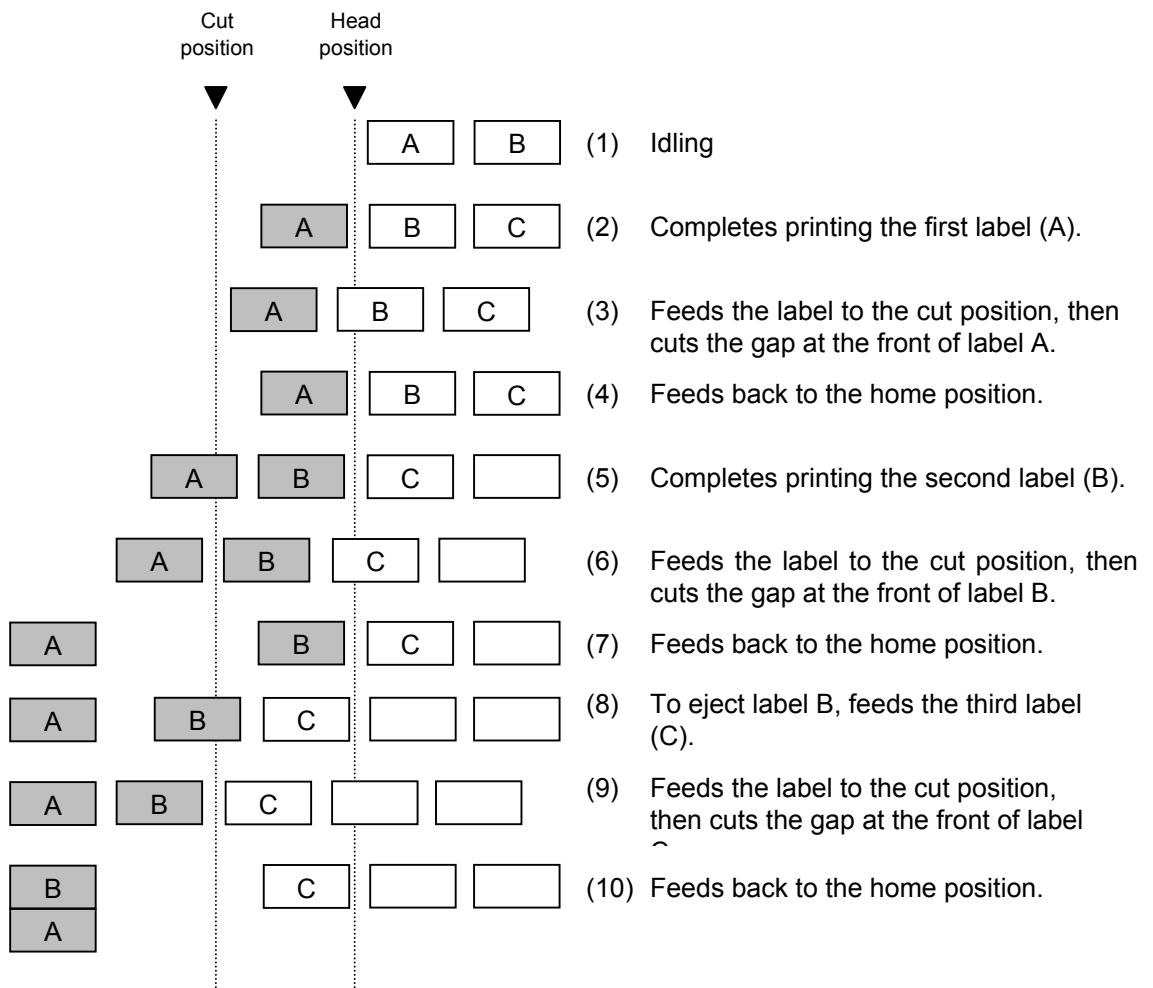

- (7) Procedure for label having less than the minimum label pitch for each issue speed when the rotary cutter is used:

When the following conditions are all met, the cut operation for the last label to be cut is as follows.

Forward feed to the cut position → Cut with feeding → Feed stops → Head lifted → Reverse feed to the home position → Head lowered

Conditions: Issue Command, Feed Command, and Eject Command received.

Label pitch: Less than the minimum label pitch for each issue speed, cut performed, transmissive sensor designated, cut position fine adjustment of ± 10.0 mm or less, and issue mode "C"

* For the Issue Command, this procedure is effective only for the last label to be cut when the next Issue Command is not received.

* The head is lifted/lowered only when the optional ribbon save module is attached and the use of the ribbon saving system is set to ON in the parameter setting. When the ribbon save module is not installed, the head-up/down operations are not performed. See "NOTES" below.

- NOTES:**
- 1. If the head is being lifted when the edge of the label which is being ejected passes the paper feed roller, the sensor may not be able to detect an error even if it occurs (a feed cannot be performed more).*
 - 2. If the head-up solenoid temperature is high when a cut issue is about to be performed with the head lifted, the head may not be lifted.*

- (8) There may be cases where a label is not returned to the home position depending on the print conditions, even if a backfeed, of which the length is the same as the forward feed, is performed. In issues where any paper sensor is used, if the label pitch length is almost the same as the distance between the thermal print head and the paper sensors (75.5 mm), a label/tag may not be returned to the home position when operations with a backfeed (such as cut issues, strip issues, automatic forward feed standby) are performed. It may result in an error. In such cases, to prevent an error from occurring, the backfeed length should be increased by performing the back feed fine adjustment in the + direction.

Examples (1) Cut issue

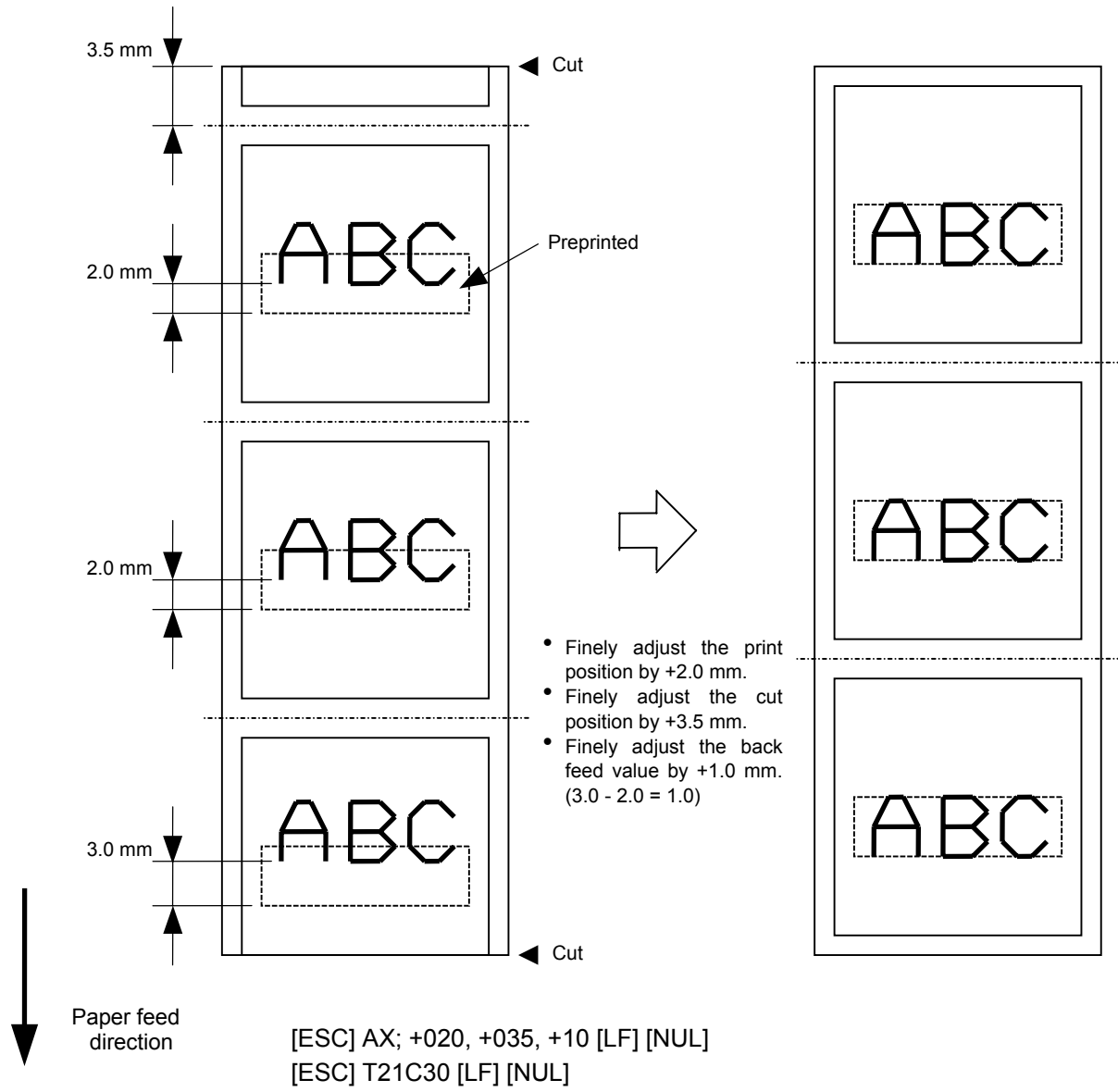

(2) Strip issue

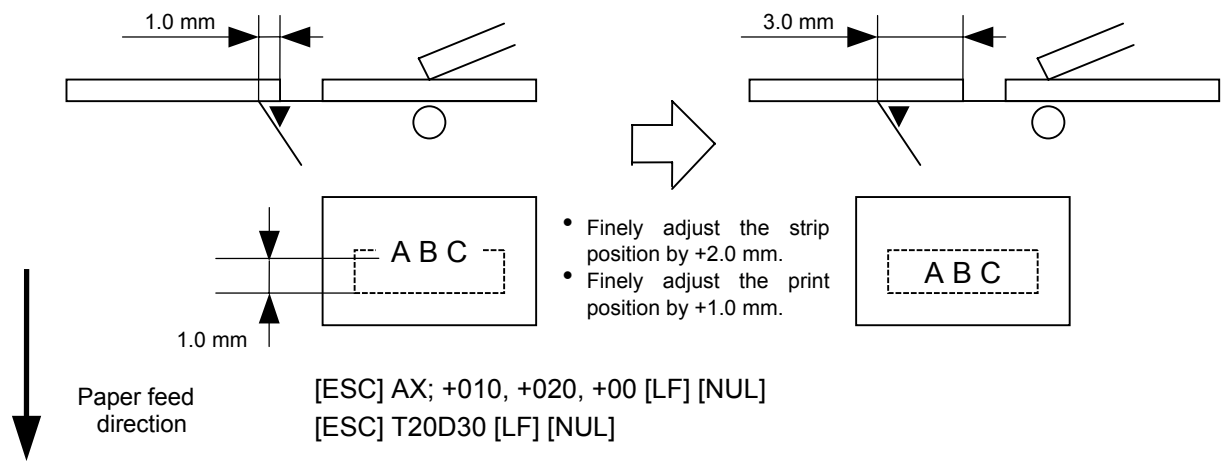

6.3.3 PRINT DENSITY FINE ADJUST COMMAND

[ESC] AY

Function	Adjusts the automatically set print density.
Format	[ESC] AY; abb, c [LF] [NUL]
Term	<p>a: Indicates whether to increase or decrease the density. +: Increase (darker) -: Decrease (lighter)</p> <p>bb: Print density fine adjustment value 00 to 10 (in units of 1 step)</p> <p>c: Indicates the mode for fine adjustment, thermal transfer or direct thermal. 0: Thermal transfer 1: Direct thermal</p>

- Explanation**
- (1) The print density fine adjustment is performed by adjusting the time that the voltage is applied to the thermal head.
 - (2) If the print density fine adjustment value has been set in system mode (key operation on the printer), the fine adjustment value will be the sum of the fine adjustment by this command and the fine adjustment in the system mode. The maximum fine adjustment values for thermal transfer/direct thermal print modes are each ± 10 .
 - (3) The fine adjustment values in thermal transfer print mode and direct thermal print mode can be set independently.
 - (4) The Print Density Fine Adjust Command is protected in memory (even if the power is turned off).
 - (5) The fine adjustment value for both the fine adjust command and the system mode fine adjustment is 00 at shipment from the factory.
 - (6) The maximum value for each print speed is as follows. When the value exceeds the maximum, it is automatically corrected to the max. value, and then the printer prints.

Print speed	B-SX4T				B-SX5T			
	V1 type: TPH104R2		V2 type: TPH104R7		V1 type: TPH128R4		V2 type: TPH128R5	
	Thermal direct	Thermal transfer	Thermal direct	Thermal transfer	Thermal direct	Thermal transfer	Thermal direct	Thermal transfer
3 ips	+10 step	+10 step	+10 step	+10 step	+10 step	+10 step	+10 step	+10 step
5 ips	----	----	----	----	+7 step	+10 step	+7 step	+10 step
6 ips	+8 step	+8 step	+8 step	+8 step	----	----	----	----
8 ips	----	----	----	----	+3 step	+10 step	+3 step	+10 step
10 ips	+4 step	+8 step	+5 step	+7 step	----	----	----	----

- Examples**
- To set the density in thermal transfer print mode to -2.
 [ESC] AY; -02, 0 [LF] [NUL]
- To set the density in direct thermal print mode to +3.
 [ESC] AY; +03, 1 [LF] [NUL]

6.3.4 RIBBON MOTOR DRIVE VOLTAGE FINE ADJUST COMMAND [ESC] RM

Function Finely adjusts the drive voltage of the ribbon motor.

Format [ESC] RM; abbcdd [LF] [NUL]

Term

- a: Fine adjustment direction of the ribbon rewind motor
-: Negative (The voltage is lowered.)
- bb: Fine adjustment value for the ribbon rewind motor
00 to 15 (in units of 1 step)
- c: Fine adjustment direction of the ribbon back tension motor
-: Negative (The voltage is lowered.)
- dd: Fine adjustment value for the ribbon back tension motor
00 to 15 (in units of 1 step)

Explanation

- (1) If wrinkles occur on the ribbon, they can be prevented by adjusting the ribbon motor drive voltage by this command.
- (2) -1 step corresponds to -5% of the standard drive voltage.
- (3) The ribbon motor drive voltage fine adjustment value is protected in memory (even if the power is turned off).
- (4) If the ribbon motor drive voltage fine adjustment value has been set in the system mode (key operation on the printer), the fine adjustment value will be the sum of the system mode and the ribbon rewind motor adjustments or the system mode and the ribbon back tension motor adjustments. The max. fine adjustment values are as shown below.

Model	Rewind		Back tension	
	Min.	Max.	Min.	Max.
B-SX4T	-15	0	-15	0
B-SX5T	-15	0	-15	0

- (5) When RAM clear is performed, the fine adjustment values for both fine adjust commands (rewind/back tension) and the system mode are 00.
- (6) The fine adjustment values for both fine adjust commands (rewind/back tension) and the system mode are 00 at the time of shipment from the factory.

Example To set the value for the ribbon motor (rewind) to -3, and the value for the ribbon motor (back tension) to -2.

[ESC] RM; -03-02 [LF] [NUL]

6.3.5 IMAGE BUFFER CLEAR COMMAND

[ESC] C

Function	Clears the image buffer for drawing characters, lines, bar codes, and graphics.
Format	[ESC] C [LF] [NUL]
Explanation	<ol style="list-style-type: none">(1) After changing the label size, the image buffer must be cleared.(2) The increment/decrement designation (described later) is valid until the Image Buffer Clear Command is transmitted.(3) The link field designation (described later) is effective until the Image Buffer Clear Command is sent.(4) The RFID format and data are cleared.(5) RFID tag position adjustment value set in the RFID Tag Position Adjustment Command @003 is cleared.
Examples	[ESC] D0508, 0760, 0468 [LF] [NUL] [ESC] T20C51 [LF] [NUL] [ESC] C [LF] [NUL] [ESC] RC000; ABC [LF] [NUL] [ESC] RC001; DEF [LF] [NUL] [ESC] XS; I, 0001, 0002C3000 [LF] [NUL]

6.3.6 CLEAR AREA COMMAND

[ESC] XR

Function	Clears the designated area or reverses the white/black dot pattern in the designated area in the drawing area.
Format	[ESC] XR; aaaa, bbbb, cccc, dddd, e [LF] [NUL]
Term	<p>aaaa: Designated area start point X-coordinate Fixed as 4 digits (in 0.1 mm units)</p> <p>bbbb: Designated area start point Y-coordinate 4 or 5 digits (in 0.1 mm units)</p> <p>cccc: Designated area end point X-coordinate Fixed as 4 digits (in 0.1 mm units)</p> <p>dddd: Designated area end point Y-coordinate 4 or 5 digits (in 0.1 mm units)</p> <p>e: Type of clear A: Clears the contents in the designated area to zeros. B: Reverses the white/black dot pattern in the designated area.</p>

Explanation

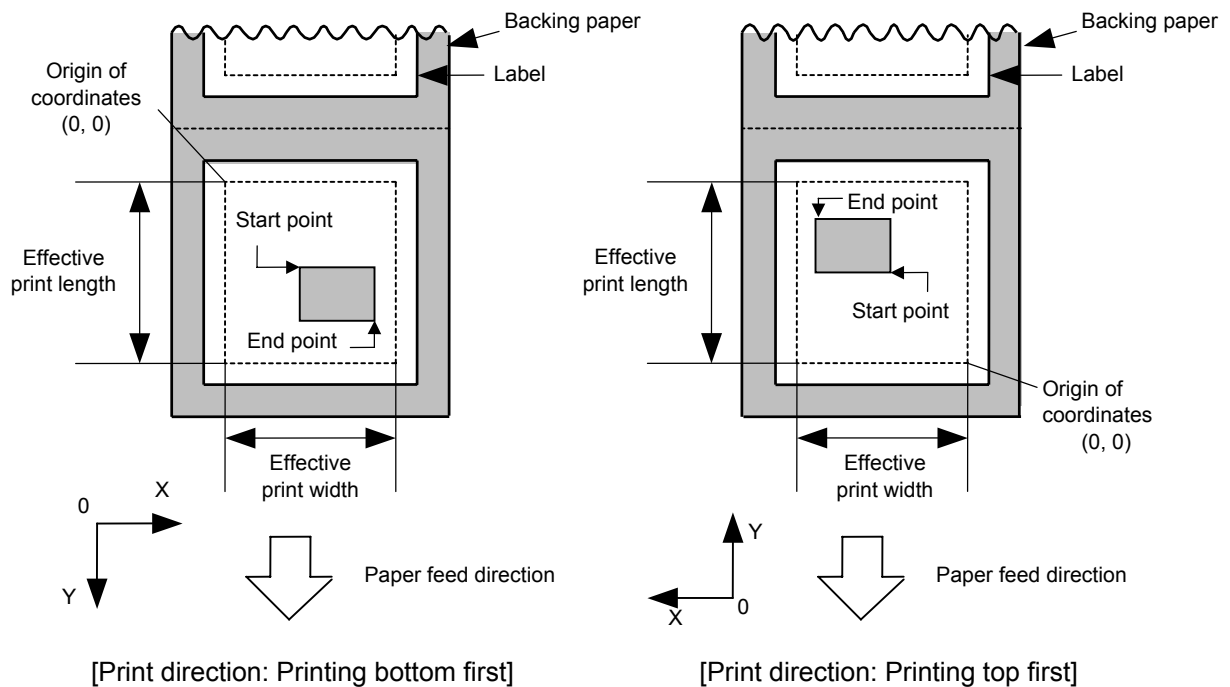

Notes	<ol style="list-style-type: none"> (1) The result is the same even if the start and end point coordinates are reversed. (2) The result is the same even if the start and end point coordinates are set to an upper right and a lower left points, respectively. (3) The start and end point coordinates of the designated area must be set within the effective print area set by the Label Size Set Command ([ESC] D).
-------	--

[Effective print area]

[mm]

Item			Model		B-SX4T					B-SX5T					
			Issue mode	Batch	Strip	Cut					Batch	Strip	Cut		
						Swing cutter	Rotary cutter		Swing cutter	Rotary cutter					
							Head-up operation not performed	Head-up operation performed		Head-up operation not performed			Head-up operation performed		
Effective print width		Min.	10.0					10.0							
		Max.	104.0					128.0							
Effective print length	Label	Min.	6.0	21.4	23.0	3 ips:	3 ips:	6.0	21.4	23.0	3 ips:	3 ips:			
						79.0	30.0				79.0	30.0			
						6 ips:	6 ips:				5 ips:	5 ips:			
						91.0	30.0				87.0	30.0			
						10 ips: –	10 ips: –				8 ips:	8 ips:			
						(NOTE 1)	(NOTE 1)				98.0	30.0			
			Max.	1496.0		1492.0		1496.0		1492.0					
	Tag	Min.	8.0	–	23.4	3 ips:	28.0	8.0	–	23.4	3 ips:	28.0			
6 ips:						28.0	5 ips:				28.0				
10 ips: –						(NOTE 1)	8 ips:				36.0				
							Max.				1498.0	–	1498.0	–	1498.0

NOTE 1: The use of the rotary cutter at 10 ips is not supported for the B-SX4T.

Examples

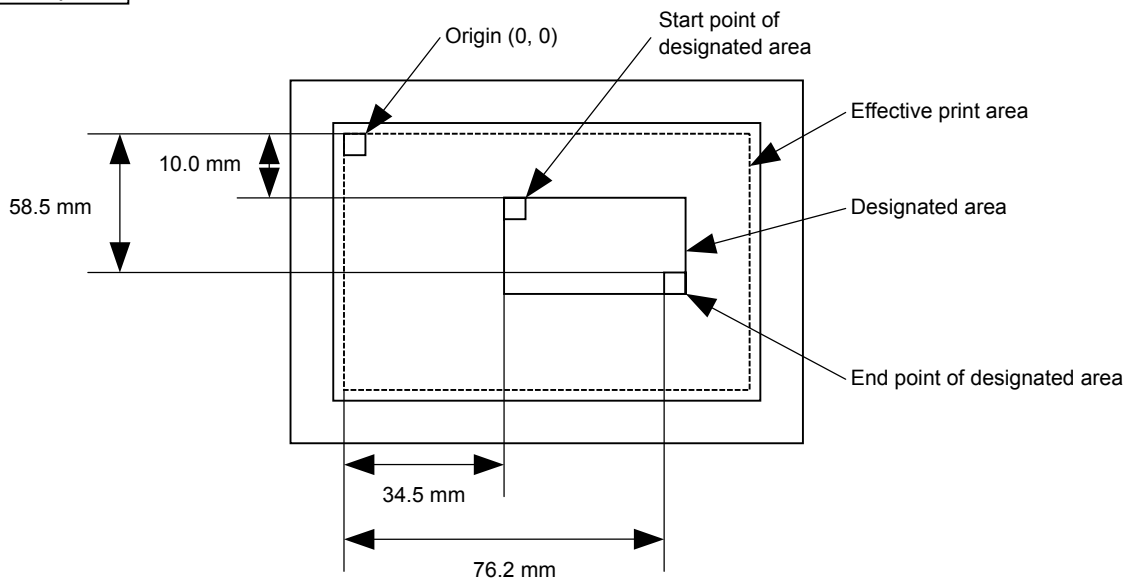

```
[ESC] XR; 0345, 0100, 0762, 0585, A [LF] [NUL]
[ESC] RC000; ABC [LF] [NUL]
[ESC] RC001; DEF [LF] [NUL]
[ESC] XS; I, 0001, 0002C3000 [LF] [NUL]
```

6.3.7 LINE FORMAT COMMAND

[ESC] LC

Function	Sets the line format and draws the line.
Format	[ESC] LC; aaaa, bbbb, cccc, dddd, e, f (, ggg) [LF] [NUL]
Term	<p>aaaa: Start point X-coordinate Fixed as 4 digits (in 0.1 mm units)</p> <p>bbbb: Start point Y-coordinate 4 or 5 digits (in 0.1 mm units)</p> <p>cccc: End point X-coordinate Fixed as 4 digits (in 0.1 mm units)</p> <p>dddd: End point Y-coordinate 4 or 5 digits (in 0.1 mm units)</p> <p>e: Type of line 0: Line (horizontal, vertical, slant) 1: Rectangle</p> <p>f: No. of line width dots 1 to 9 (in 0.1 mm units)</p> <p>ggg: Radius of rounded corners of rectangles (Omissible. If omitted, the chamfering process for rectangle corners is not performed.) Fixed as 3 digits (in 0.1 mm units)</p>

Explanation

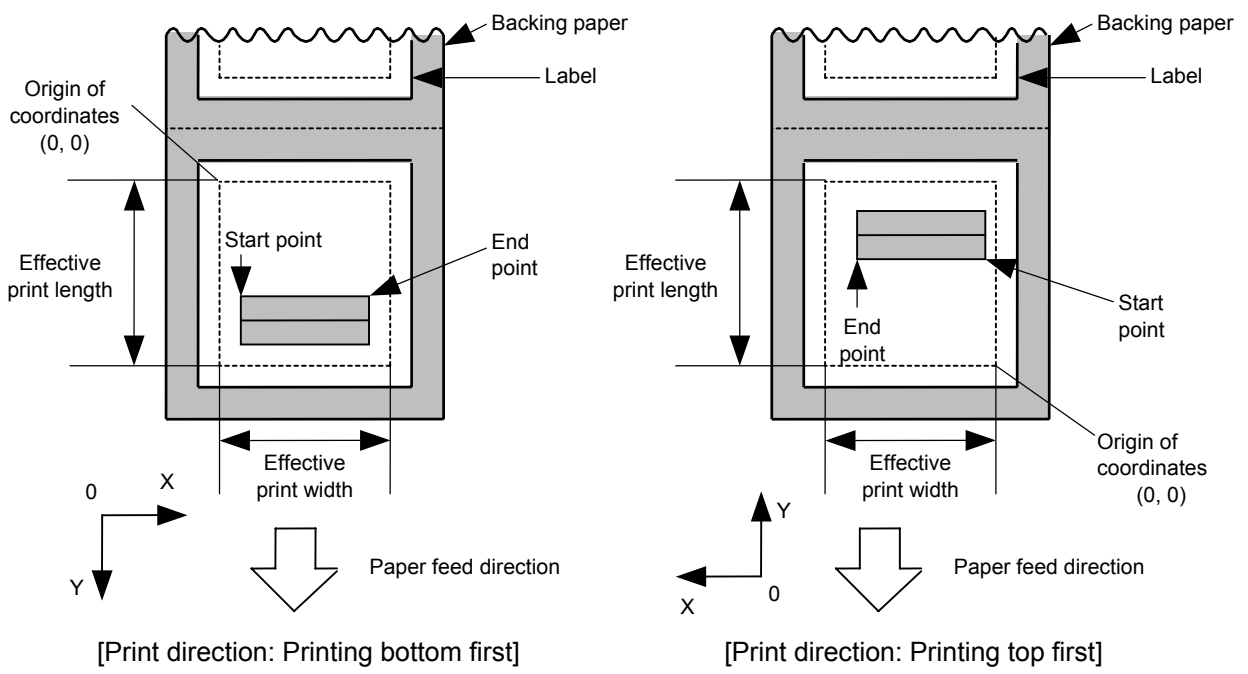

[Line]

(1) Horizontal line (In the case of $|Y_2 - Y_1| = 0$)

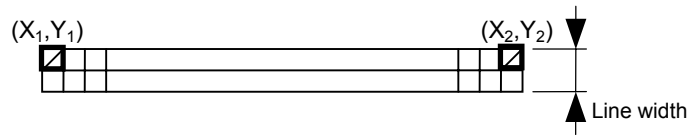

(2) Vertical line (In the case of $|X_2 - X_1| = 0$)

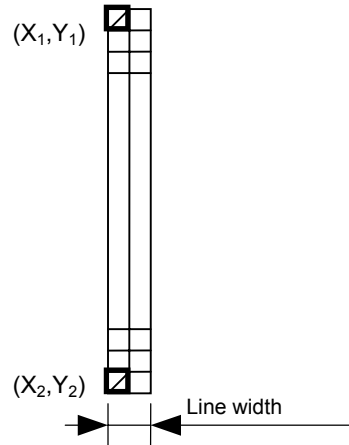

(3) Slant line A ($|X_2 - X_1| \leq |Y_2 - Y_1|$)

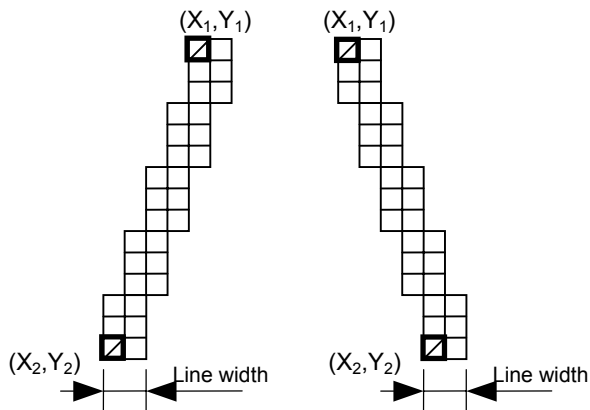

(4) Slant line B ($|X_2 - X_1| > |Y_2 - Y_1|$)

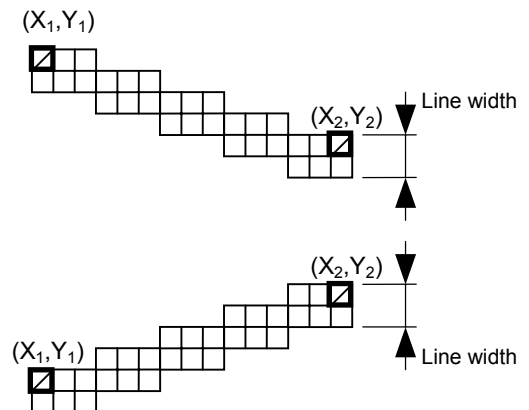

[Rectangle]

(1) Radius of rounded corners = 000 or parameter omitted

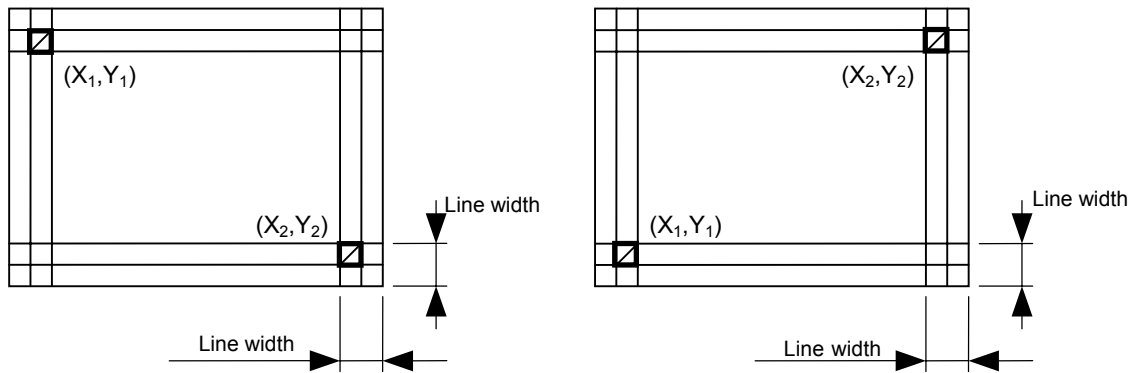

(2) Radius of rounded corners \neq 000

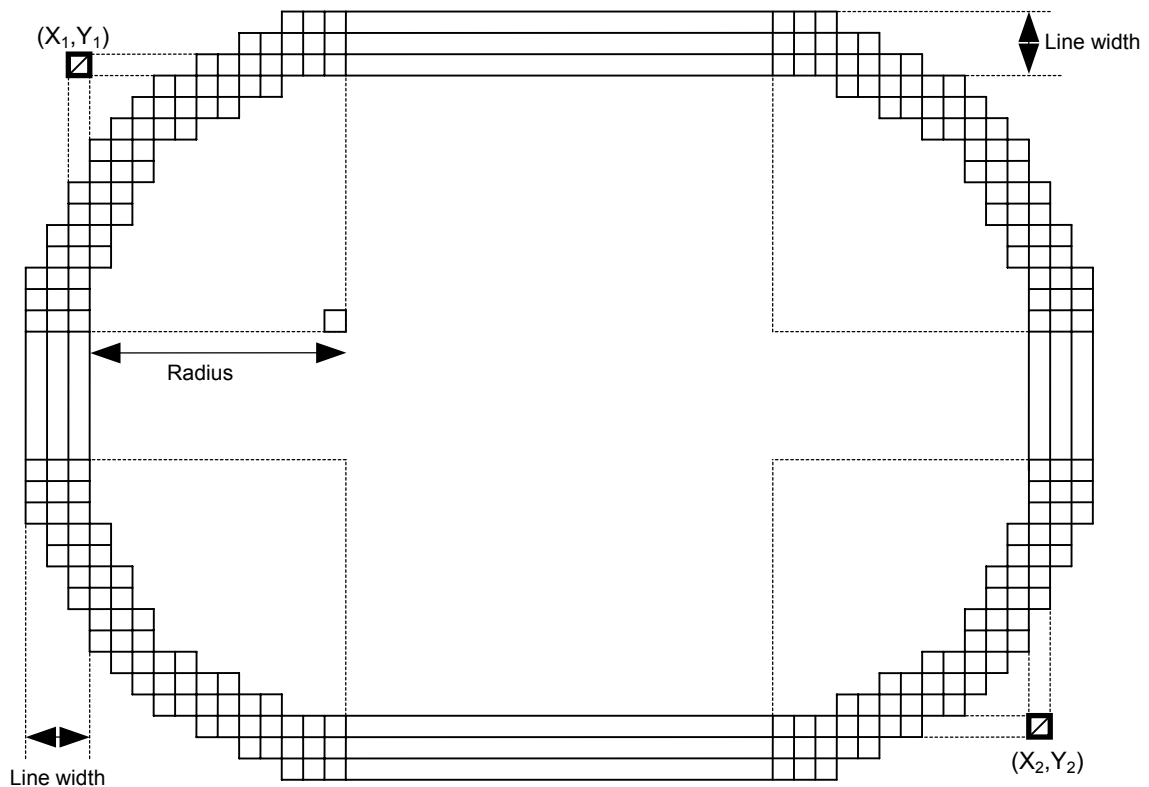

Notes

- (1) In line designation, a horizontal line, vertical line, or slant line A/B is drawn according to the start and end point coordinates.
- (2) The result is the same even if the start and end point coordinates are reversed.
- (3) The start and end point coordinates must be set so that the result of line drawing will be within the effective print area set by the Label Size Set Command ([ESC] D).

- (4) Programming the radius of the rounded corner is effective only when the type of line is 1 (rectangle). When the type of line is 0, designation of the radius is ignored. When the type of line is 1, and the radius of the rounded corner is 000 or omitted, a rectangle is printed.

- (5) A circle is assumed when:

$$\frac{|X_2 - X_1|}{2} = \frac{|Y_2 - Y_1|}{2} \leq [\text{Radius of rounded corners}]$$

[Effective print area]

[mm]

Item		Model		B-SX4T					B-SX5T				
				Batch	Strip	Cut			Batch	Strip	Cut		
						Swing cutter	Rotary cutter				Swing cutter	Rotary cutter	
		Min.	10.0					10.0					
		Max.	104.0					128.0					
Effective print length	Label	Min.	6.0	21.4	23.0	3 ips: 79.0	3 ips: 30.0	6.0	21.4	23.0	3 ips: 79.0	3 ips: 30.0	
						6 ips: 91.0	6 ips: 30.0				5 ips: 87.0	5 ips: 30.0	
						10 ips: – (NOTE 1)	10 ips: – (NOTE 1)				8 ips: 98.0	8 ips: 30.0	
		Max.	1496.0		1492.0		1496.0		1492.0				
	Tag	Min.	8.0	–	23.4	3 ips: 28.0		8.0	–	23.4	3 ips: 28.0		
						6 ips: 28.0					5 ips: 28.0		
10 ips: – (NOTE 1)						8 ips: 36.0							
	Max.	1498.0	–	1498.0		1498.0	–	1498.0					

NOTE 1: The use of the rotary cutter at 10 ips is not supported for the B-SX4T.

Examples

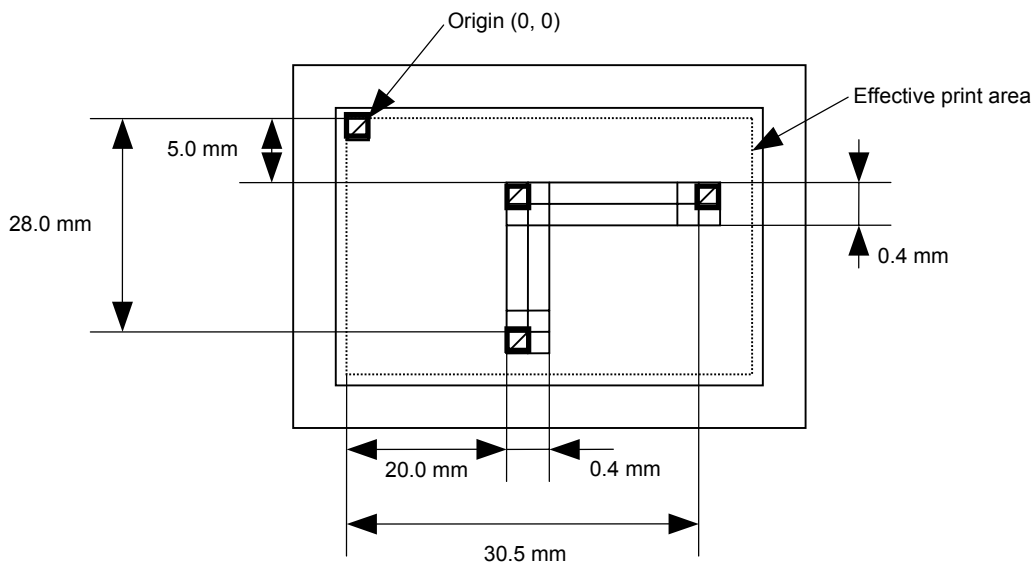

```
[ESC] C [LF] [NUL]
[ESC] LC; 0200, 0350, 0305, 0050, 0, 4 [LF] [NUL]
[ESC] LC; 0200, 0050, 0200, 0280, 0, 4 [LF] [NUL]
[ESC] XS; 1, 0001, 0002C3000 [LF] [NUL]
```

6.3.8 BIT MAP FONT FORMAT COMMAND

[ESC] PC

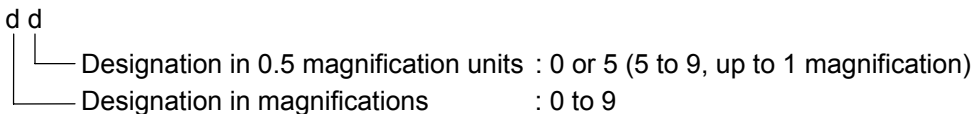
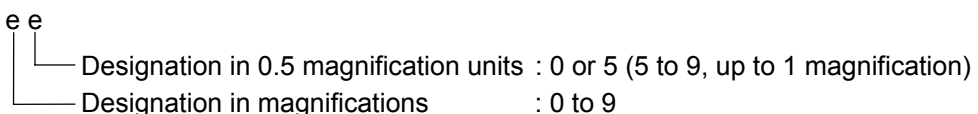
Function	Sets the format indicating the position on the label at which the bit map font is to be printed and how it is to be printed.																																												
Format	<p>① [ESC] PCaaa; bbbb, cccc, d, e, ff (, ghh), ii, j (, Jkkl) (, Mm) (, noooooooooo) (, Zpp) (, Pq) (=rrr-----rrr) [LF] [NUL]</p> <p>② [ESC] PCaaa; bbbb, cccc, d, e, ff (, ghh), ii, j (, Jkkl) (, Mm) (, noooooooooo) (, Zpp) (, Pq) (; ss₁, ss₂, ss₃, -----, ss₂₀) [LF] [NUL]</p>																																												
Term	aaa:	Character string number 000 to 199 (two digits, 00 to 99, also acceptable)																																											
	bbbb:	Print origin of X-coordinate of character string Fixed as 4 digits (in 0.1 mm units)																																											
	cccc:	Print origin of Y-coordinate of character string 4 or 5 digits (in 0.1 mm units)																																											
	d:	Character horizontal magnification 1 to 9 (in magnifications) * Two digit designation enables magnifications in 0.5 units (05 ~ 95: 0.5 to 9.5 magnifications). The magnification can be designated in 0.1 units between 0.5 and 1. (06 ~ 09: 0.6 to 0.9 magnifications). d d 																																											
	e:	Character vertical magnification 1 to 9 (in magnifications) * Two digit designation enables magnifications in 0.5 units (05 ~ 95: 0.5 to 9.5 magnifications). The magnification can be designated in 0.1 units between 0.5 and 1. (06 ~ 09: 0.6 to 0.9 magnifications). e e 																																											
	ff:	Type of font	<table border="1" style="width: 100%; border-collapse: collapse;"> <thead> <tr> <th></th> <th>B-SX4T</th> <th>B-SX5T</th> </tr> </thead> <tbody> <tr><td>A: Times Roman (Medium)</td><td>12 point</td><td>8 point</td></tr> <tr><td>B: Times Roman (Medium)</td><td>15 point</td><td>10 point</td></tr> <tr><td>C: Times Roman (Bold)</td><td>15 point</td><td>10 point</td></tr> <tr><td>D: Times Roman (Bold)</td><td>18 point</td><td>12 point</td></tr> <tr><td>E: Times Roman (Bold)</td><td>21 point</td><td>14 point</td></tr> <tr><td>F: Times Roman (Italic)</td><td>18 point</td><td>12 point</td></tr> <tr><td>G: Helvetica (Medium)</td><td>9 point</td><td>6 point</td></tr> <tr><td>H: Helvetica (Medium)</td><td>15 point</td><td>10 point</td></tr> <tr><td>I: Helvetica (Medium)</td><td>18 point</td><td>12 point</td></tr> <tr><td>J: Helvetica (Bold)</td><td>18 point</td><td>12 point</td></tr> <tr><td>K: Helvetica (Bold)</td><td>21 point</td><td>14 point</td></tr> <tr><td>L: Helvetica (Italic)</td><td>18 point</td><td>12 point</td></tr> <tr><td>M: Presentation (Bold)</td><td>27 point</td><td>18 point</td></tr> </tbody> </table>		B-SX4T	B-SX5T	A: Times Roman (Medium)	12 point	8 point	B: Times Roman (Medium)	15 point	10 point	C: Times Roman (Bold)	15 point	10 point	D: Times Roman (Bold)	18 point	12 point	E: Times Roman (Bold)	21 point	14 point	F: Times Roman (Italic)	18 point	12 point	G: Helvetica (Medium)	9 point	6 point	H: Helvetica (Medium)	15 point	10 point	I: Helvetica (Medium)	18 point	12 point	J: Helvetica (Bold)	18 point	12 point	K: Helvetica (Bold)	21 point	14 point	L: Helvetica (Italic)	18 point	12 point	M: Presentation (Bold)	27 point	18 point
	B-SX4T	B-SX5T																																											
A: Times Roman (Medium)	12 point	8 point																																											
B: Times Roman (Medium)	15 point	10 point																																											
C: Times Roman (Bold)	15 point	10 point																																											
D: Times Roman (Bold)	18 point	12 point																																											
E: Times Roman (Bold)	21 point	14 point																																											
F: Times Roman (Italic)	18 point	12 point																																											
G: Helvetica (Medium)	9 point	6 point																																											
H: Helvetica (Medium)	15 point	10 point																																											
I: Helvetica (Medium)	18 point	12 point																																											
J: Helvetica (Bold)	18 point	12 point																																											
K: Helvetica (Bold)	21 point	14 point																																											
L: Helvetica (Italic)	18 point	12 point																																											
M: Presentation (Bold)	27 point	18 point																																											

N:	Letter Gothic	(Medium)	14.3 point	9.5 point
O:	Prestige Elite	(Medium)	10.5 point	7 point
P:	Prestige Elite	(Bold)	15 point	10 point
Q:	Courier	(Medium)	15 point	10 point
R:	Courier	(Bold)	18 point	12 point
S:	OCR-A		12 point	12 point
T:	OCR-B		12 point	12 point

a: (Reserved)

b: (Reserved)

c: (Reserved)

d: (Reserved)

e: Chinese (24 × 24 dots) (Song) (for CN only)

f: (Reserved)

g: (Reserved)

h: (Reserved)

i: (Reserved)

j: Chinese (32 × 32 dots) (Hei) (for CN only)

k: (Reserved)

l: (Reserved)

m: (Reserved)

n: (Reserved)

o: (Reserved)

p: (Reserved)

q: Gothic725 Black

01 (a): Writable character 1 (1×1 dot to 720×720 dots)

to

40 (a): Writable character 40 (1×1 dot to 720×720 dots)

51 (a): 2-byte code set writable character 1 (1×1 dot to 720×720 dots)

to

55 (a): 2-byte code set writable character 5 (1×1 dot to 720×720 dots)

a: Drive

(Omissible. If omitted, flash ROM on the CPU board is selected.)

0: Flash ROM on the CPU board

1: Slot 1 on the PCMCIA board (Option)

2: Slot 2 on the PCMCIA board (Option)

* The following fonts are proportional.

A, B, C, D, E, F, G, H, I, J, K, L, q

ghh: Fine adjustment of character-to-character space

(Omissible. If omitted, space is adjusted according to the designated font.)

g: Designates whether to increase or decrease the character-to-character space.

+: Increase

-: Decrease

hh: No. of space dots between characters

00 to 99 (in dots)

- ii: Rotational angles of a character and character string
- | | | | |
|-----|--------------|---------------------|-----------------------------------|
| 00: | 0° (char.) | 0° (char.-string) | |
| 11: | 90° (char.) | 90° (char.-string) | |
| 22: | 180° (char.) | 180° (char.-string) | |
| 33: | 270° (char.) | 270° (char.-string) | |
| 01: | 0° (char.) | 90° (char.-string) | } For font types "e" and "j" only |
| 12: | 90° (char.) | 180° (char.-string) | |
| 23: | 180° (char.) | 270° (char.-string) | |
| 30: | 270° (char.) | 0° (char.-string) | |
- j: Character attribution
- B: Black character
- W (aabb): Reverse character
- aa: No. of dots from the character string to the end of the black background in the horizontal direction
- bb: No. of dots from the character string to the end of the black background in the vertical direction
- aa: 01 to 99 (in units of dots)
- bb: 01 to 99 (in units of dots)
- F (aabb): Boxed character
- aa: No. of dots from the character string area to the box in the horizontal direction
- bb: No. of dots from the character string area to the box in the vertical direction
- aa: 01 to 99 (in units of dots)
- bb: 01 to 99 (in units of dots)
- C (aa): Stroked out character
- aa: No. of dots from the character string area to the end of the stroke
- aa: 01 to 99 (in units of dots)
- * Descriptions in parentheses are omissible.
(If omitted, it is the character magnification (the larger one of horizontal or vertical magnifications) × 6 dots.)
- Jkkl: Bold character designation
(Omissible. If omitted, this process is not performed.)
- kk: No. of horizontal shift dots
00 to 16 (in dots)
- ll: No. of vertical shift dots
00 to 16 (in dots)
- Mm: Type of check digit to be attached
(Omissible. If omitted, the check digit is not drawn.)
- m: Type of check digit
- 0: Modulus 10 (Draws data and check digit)
- 1: Modulus 43 (Draws data and check digit)
- 2: DBP Modulus 10 (Draws check digit only)

nooooooooo: Increment and decrement
(Omissible. If omitted, incrementing/decrementing is not performed.)
n: Designates whether to increment or decrement.
+: Increment
-: Decrement

oooooooooooo: Skip value
0000000000 to 9999999999

Zpp: Zero suppression
(Omissible. If omitted, the zero suppression process is not performed.)
pp: No. of zeros to be suppressed
00 to 20

Pq: Alignment (Omissible. If omitted, the alignment is set to the left.)
q: Designates the character position
1: Left
2: Center
3: Right
4aaaa: Equal space
aaaa: X direction of character string area
0050 to 1040 (in 0.1 mm units)

5aaaabbbcc: Automatic line feed
aaaa: X direction of character string area
0050 to 1040 (in 0.1 mm units)
bbb: Line feed length
010 to 500 (in 0.1 mm units)
cc: Number of lines
01 to 99

rrr-----rrr: Data string to be printed (Omissible)
Max. 255 digits

ss₁, ss₂, ss₃, -----, ss₂₀: Link field No. (Omissible)
01 to 99 (1 to 99 can also be used.)
Up to 20 fields can be designated using commas.

Explanation

(1) Character string number

When drawing by the Data Command ([ESC] RC), the format designated by the character string number is selected.

(2) Print origin of coordinates

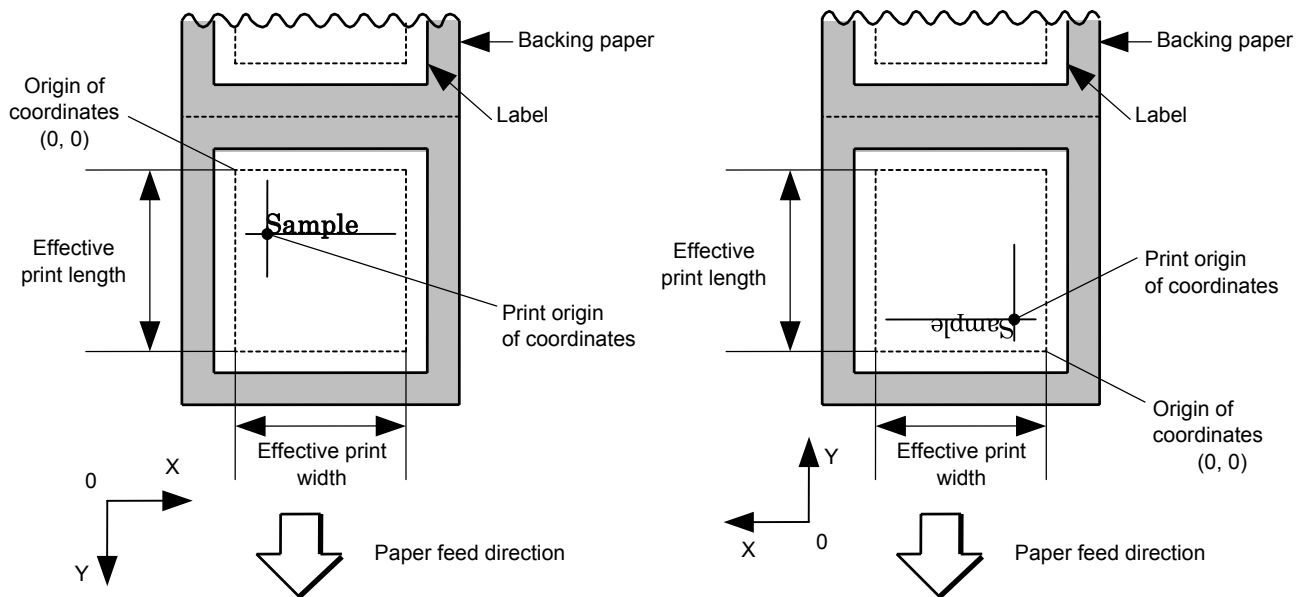

[Printing direction: Printing bottom first]

[Printing direction: Printing top first]

The print origin of coordinates must be set so that the character drawing result will be within the effective print area set by the Label Size Set Command ([ESC] D).

[Effective print area]

[mm]

Item		Model		B-SX4T					B-SX5T				
		Issue mode	Batch	Strip	Cut				Batch	Strip	Cut		
					Swing cutter	Rotary cutter		Swing cutter			Rotary cutter		
						Head-up operation not performed	Head-up operation performed				Head-up operation not performed	Head-up operation performed	
Effective print width		Min.	10.0					10.0					
		Max.	104.0					128.0					
Effective print length	Label	Min.	6.0	21.4	23.0	3 ips: 79.0	3 ips: 30.0	6.0	21.4	23.0	3 ips: 79.0	3 ips: 30.0	
						6 ips: 91.0	6 ips: 30.0				5 ips: 87.0	5 ips: 30.0	
						10 ips: – (NOTE 1)	10 ips: – (NOTE 1)				8 ips: 98.0	8 ips: 30.0	
						Max.					1496.0		1492.0
	Tag	Min.	8.0	–	23.4	3 ips: 28.0		8.0	–	23.4	3 ips: 28.0		
						6 ips: 28.0					5 ips: 28.0		
						10 ips: – (NOTE 1)					8 ips: 36.0		
						Max.					1498.0		1498.0

NOTE 1: The use of the rotary cutter at 10 ips is not supported for the B-SX4T.

(3) Horizontal magnification and vertical magnification

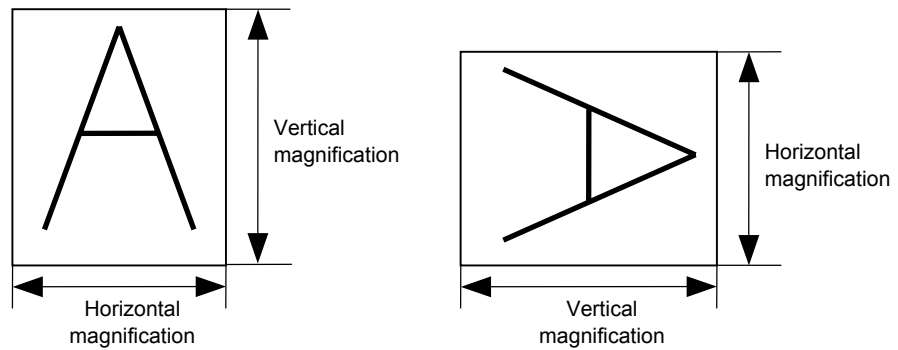

[Relationship between drawing coordinates and magnification]

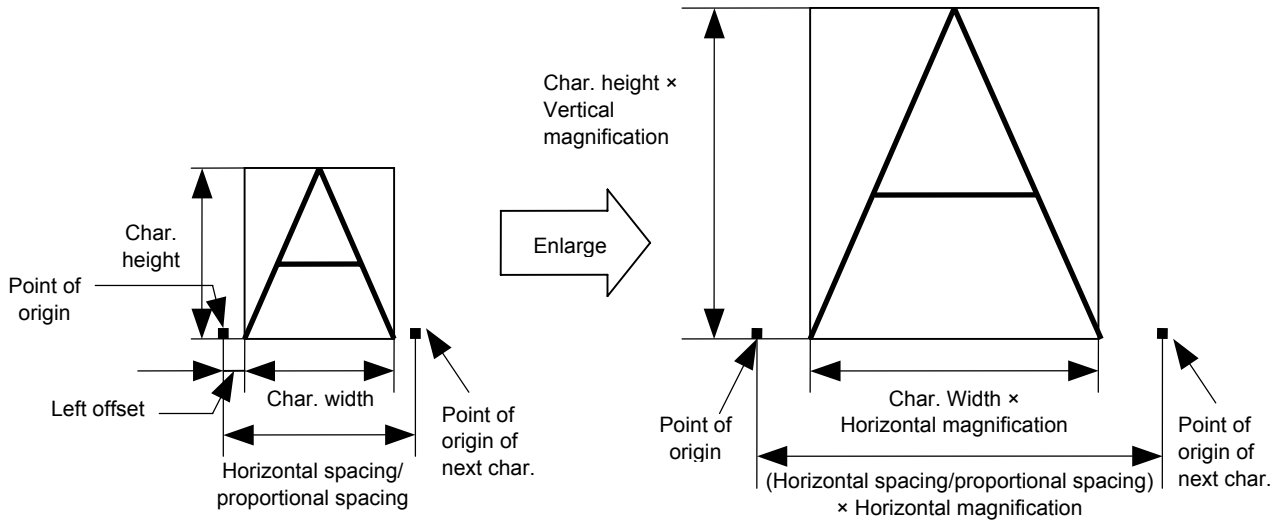

(4) Type of font

- A: Times Roman : !"#\$%&'()*+,-./0123456789;<=>?@ABCDEFGHIJKLMabcdefghijklmÂÏØÆàîÆ
- B: Times Roman : !"#\$%&'()*+,-./0123456789;<=>?@ABCDEFGHIJabcdefghijklgÂÏØÆàîÆ
- C: Times Roman : !"#\$%&'()*+,-./0123456789;<=>?@ABCDEFGHIJabcdefghijklgÂÏØÆàîÆ
- D: Times Roman : !"#\$%&'()*+,-./0123456789;<=>?@ABCDEFGHIJabcdefghijklgÂÏØÆàîÆ
- E: Times Roman : !"#\$%&'()*+,-./0123456789@ABCDEFGHIJabcdefghijklgÂÏØÆàîÆ
- F: Times Roman : !"#\$%&'()*+,-./0123456789@ABCDEFGHIJabcdefghijklgÂÏØÆàîÆ
- G: Helvetica : !"#\$%&'()*+,-./0123456789;<=>?@ABCDEFGHIJKLMNopqrstuvwxyzwÂÏØÆàîÆ
- H: Helvetica : !"#\$%&'()*+,-./0123456789;<=>?@ABCDEFGHIJhabcdefghijklgÂÏØÆàîÆ
- I: Helvetica : !"#\$%&'()*+,-./0123456789@ABCDEFGHIJhabcdefghijklgÂÏØÆàîÆ
- J: Helvetica : !"#\$%&'()*+,-./0123456789@ABCDEFGHIJhabcdefghijklgÂÏØÆàîÆ
- K: Helvetica : !"#\$%&0123456789@ABCDEFGHIJhabcdefghijklgÂÏØÆàîÆ
- L: Helvetica : !"#\$%&'()*+,-./0123456789@ABCDEFGHIJhabcdefghijklgÂÏØÆàîÆ
- M: Presentation : **!"#\$%&0123456789@ABCDEFGHIJABCDEFGHI**
- N: Letter Gothic : !"#\$%&'()*+,-./0123456789;<=>?@ABCDEFGHIJKLMNopabcdefghijklmnoÂÏØÆàîÆ
- O: Prestige Elite : !"#\$%&'()*+,-./0123456789;<=>?@ABCDEFGHIJKLMNopabcdefghijklmnoÂÏØÆàîÆ
- P: Prestige Elite : !"#\$%&'()*+,-./0123456789;<=>?@ABCDEFGHIJhabcdefghijklgÂÏØÆàîÆ
- Q: Courier : !"#\$%&'()*+,-./0123456789;<=>?@ABCDEFGHIJhabcdefghijklgÂÏØÆàîÆ
- R: Courier : !"#\$%&'()*+,-./0123456789@ABCDEFGHIJhabcdefghijklgÂÏØÆàîÆ
- S: OCR-A : !"#\$%&'()*+,-./0123456789;<=>?@ABCDEFGHIJhabcdefghijklgÂÏØÆàîÆ
- T: OCR-B : !"#\$%&'()*+,-./0123456789;<=>?@ABCDEFGHIJhabcdefghijklgÂÏØÆàîÆ

(7) Selection of character attribution

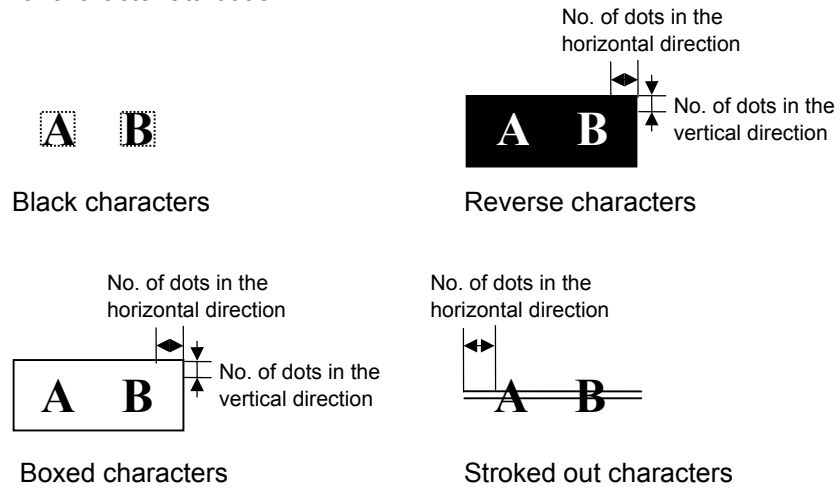

(8) Bold character designation

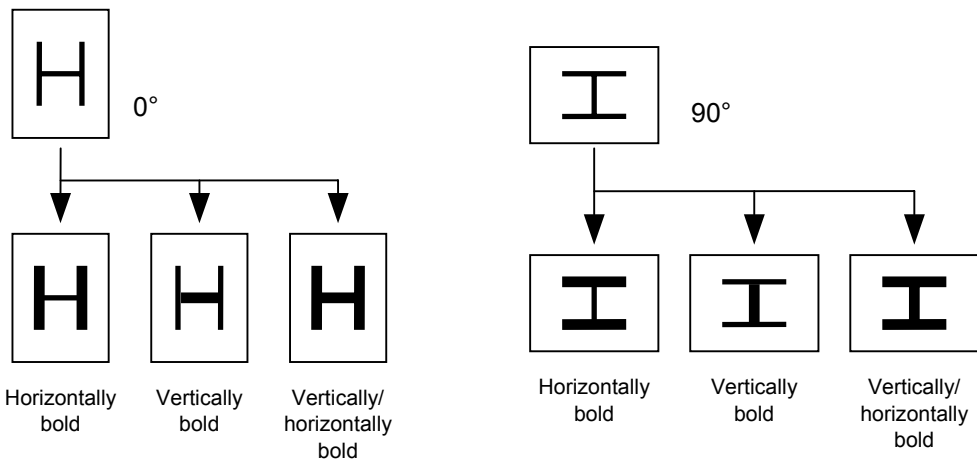

(9) Check digit to be attached

When Modulus 10 or Modulus 43 is selected, the check digit of a data row is calculated and attached to the data row for drawing. When modulus 10 is designated and the data includes any data other than the numerals, the data row will not be drawn. When modulus 43 is designated and the data includes any character other than CODE39, the drawing is not performed.

When DBP Modulus 10 is selected, the check digit of a data row is calculated and only the check digit is drawn. When the data includes any data other than the numerals, drawing is not performed.

* DBP Modulus 10 is Modulus 10 for Deutsche Bundespost Postdienst only.

(10) Increment/decrement

Printing is performed while the data is incremented or decremented every time a label is issued. Where the data row exceeds the maximum number of digits (40), the data row will not be drawn. When the font type is e, j, 51, 52, 53, 54, or 55, the incrementing/decrementing cannot be designated. (If it is designated, it is ignored, and the printer operates as if there was no designation.)

Initial value	0000	0000	0000	0000	999999
INC/DEC	+10	+10	+10	+10	+1
Zero suppression	Not designated	5	3	0	3
1st label	0000	0000	└000	0000	999999
2nd label	0010	0010	└010	0010	└└└000
3rd label	0020	0020	└020	0020	└└└001
4th label	0030	0030	└030	0030	└└└002
5th label	0040	0040	└040	0040	└└└003

Letters and numerals for increment/decrement

For the data string, up to 40 digits (including letters, numerals, and symbols) are possible. Only the numerals are selected and calculated for incrementing/decrementing, and then are returned to the previous position to draw the data.

Example of increment/decrement calculation

Initial value	00000	A0A0A	7A8/9	A2A0A
INC/DEC	+1	+1	+3	-3
1st label	00000	A0A0A	7A8/9	A2A0A
2nd label	00001	A0A1A	7A9/2	A1A7A
3rd label	00002	A0A2A	7A9/5	A1A4A
4th label	00003	A0A3A	7A9/8	A1A1A
5th label	00004	A0A4A	8A0/1	A0A8A

(11) Zero suppression

No. of zeros to be suppressed	0	1	2	2	3	4	5
Data	0000	0000	0000	0A12	0123	0123	0123
Print	0000	└└└0	└└00	└A12	└123	0123	0123

The leading zero(s) in a data row is replaced by a space(s) according to the designated number of digits. However, if the number of digits to be suppressed is greater than the data row, the data row will be drawn without zero suppression. Where the data row exceeds the maximum number of digits (40), the data row will not be drawn. When the font type is e, j, 51, 52, 53, 54 or 55, zero suppression is not designated. If it is designated, it is ignored, and the printer operates as if there was no designation.

(12) Alignment

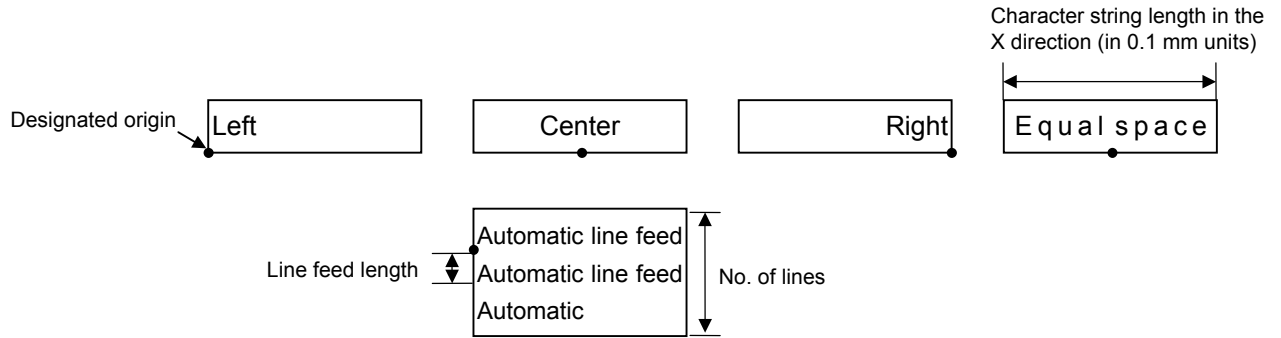

If characters are not placed on one line when equal space and automatic line feed is designated, the following steps should be performed.

Decrease the value of the character-to-character space. When characters are not placed on one line if the value is set to 0, return the value to its default, and then reduce the horizontal magnification for a character by 0.5.

If characters are still not placed on one line, repeatedly decrease the value of the character-to-character space, and then reduce the horizontal magnification. When characters are not placed on one line if the character magnification is set to 0.5 and the character-to-character space is set to 0, the field is not drawn. (The same previous field is not drawn.)

When "01", "12", "23", or "30" is specified for the rotational angles of a character and character string, the alignment setting (Center, Right, Equal space, or Automatic line feed) is ignored.

(13) Data string to be printed

Drawing data can be programmed by designating the number of digits after the symbol "=". Up to 255 digits can be printed. However, when the font type is "e" and "j", the maximum number of digits is 127. If the number of digits exceeds the maximum value, the excessive data will be discarded.

For the character code table, refer to chapter 12 "CHARACTER CODE TABLE".

(14) Link field No.

The link field No. can be programmed by designating it after the symbol “;”. After the link field No. is designated using the Format Command, the data strings are linked by the Link Field Data Command to draw an image.

Up to 20 fields can be linked.

The following shows an example of linked fields on the two continuous labels.

[Format Command]

[ESC] PC01;..... ; 01 [LF] [NUL] : Link field No. 1 is designated.
[ESC] PC02;..... ; 03 [LF] [NUL] : Link field No. 3 is designated.
[ESC] PC03;..... ; 04 [LF] [NUL] : Link field No. 4 is designated.
[ESC] XB01;..... ; 03, 04 [LF] [NUL] : Link fields No. 3 and No. 4 are designated.

[ESC] PC04;..... ; 02 [LF] [NUL] : Link field No. 2 is designated.
[ESC] PC05;..... ; 03 [LF] [NUL] : Link field No. 3 is designated.
[ESC] PC06;..... ; 04 [LF] [NUL] : Link field No. 4 is designated.
[ESC] XB02;..... ; 03, 04 [LF] [NUL] : Link fields No. 3 and No. 4 are designated.

Designating the link field No.

[Data Command]

[ESC] RC; A [LF] B [LF] ABCD [LF] 001 [LF] [NUL]
Link field No. 1
Link field No. 2
Link field No. 3
Link field No. 4

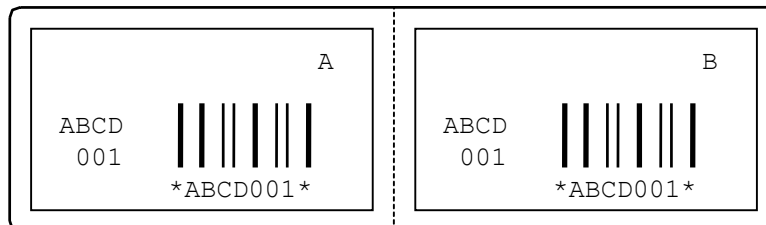

Notes

- (1) The check digit attachment, increment/decrement, and zero suppress processes are performed according to the following priority. If any of the conditions are improper, no drawing will take place.

[For example, the zero(s) is replaced by a space(s) as a result of zero suppression but the modulus 10 designated to be attached cannot be calculated.]

Increment/decrement > zero suppression > attachment of check digit

- (2) Up to 32 fields for which incrementing/decrementing has been designated can be drawn. If the total bit map font, outline font, and bar code increment/decrement fields exceeds 32, drawing will take place without incrementing/decrementing any excessive field. The field to be incremented or decremented is incremented or decremented until the Image Buffer Clear Command ([ESC] C) is transmitted.

[Example]

- 1) Format Command (Increment character string No. 001 (+1))
- 2) Format Command (No incrementing for character string No. 002)
- 3) Format Command (Increment character string No. 003 (+2))
- 4) Image Buffer Clear Command
- 5) Data Command (Character string No. 001 "0001")
- 6) Data Command (Character string No. 002 "AB-")
- 7) Data Command (Character string No. 003 "0100")
- 8) Issue Command (2 labels)

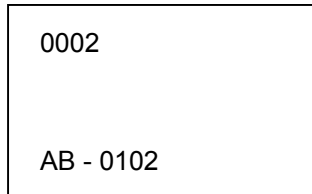
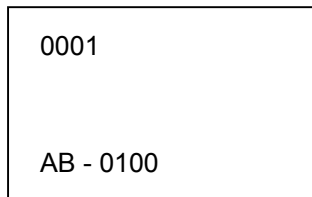

- 9) Issue Command (1 label)

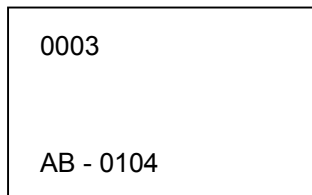

- 10) Image Buffer Clear Command
- 11) Data Command (Character string No. 002 "00000")
- 12) Issue Command (1 label)

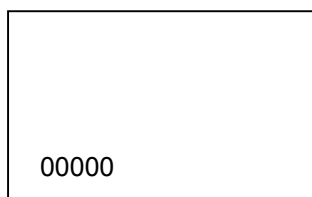

- (3) The Bit Map Font Format Command may be connected to the Outline Font Format Command when transmitted.

```
[ESC] P C001; 0100, 0150, 1, 1, A, 00, B [LF]
        C002; 0350, 0180, 1, 1, A, 00, B [LF]
        C005; 0200, 0300, 25, 2, C, +05, 00, B, +0000000001 [LF]
        V01; 0500, 0400, 0100, 0100, A, 00, B [LF] [NUL]
```

- (4) When the drawing data is changed per label issue during printing, the drawing data field for the previous label is automatically cleared using the character string number. Then the next drawing data is printed. Therefore, the character string number which differs according to the drawing fields should be designated. Since the automatic field clear is not performed between the Clear Command ([ESC] C) and Issue Command ([ESC] XS), the fixed data may be drawn using the same character string number. In this case, the Format Command and Data Command should be sent alternately. (After the Issue Command is sent, the fields with the same character string number are automatically cleared until the Clear Command is sent.)
- (5) The link field designation can be cleared by omitting the link field designation using the same character string No. and reformatting data.
The link field designation can also be cleared by the Image Buffer Clear Command.
- (6) A print data string and the link field No. cannot be programmed at the same time.

Refer to

Bit Map Font Data Command ([ESC] RC)
Outline Font Format Command ([ESC] PV)
Bar Code Format Command ([ESC] XB)

Examples

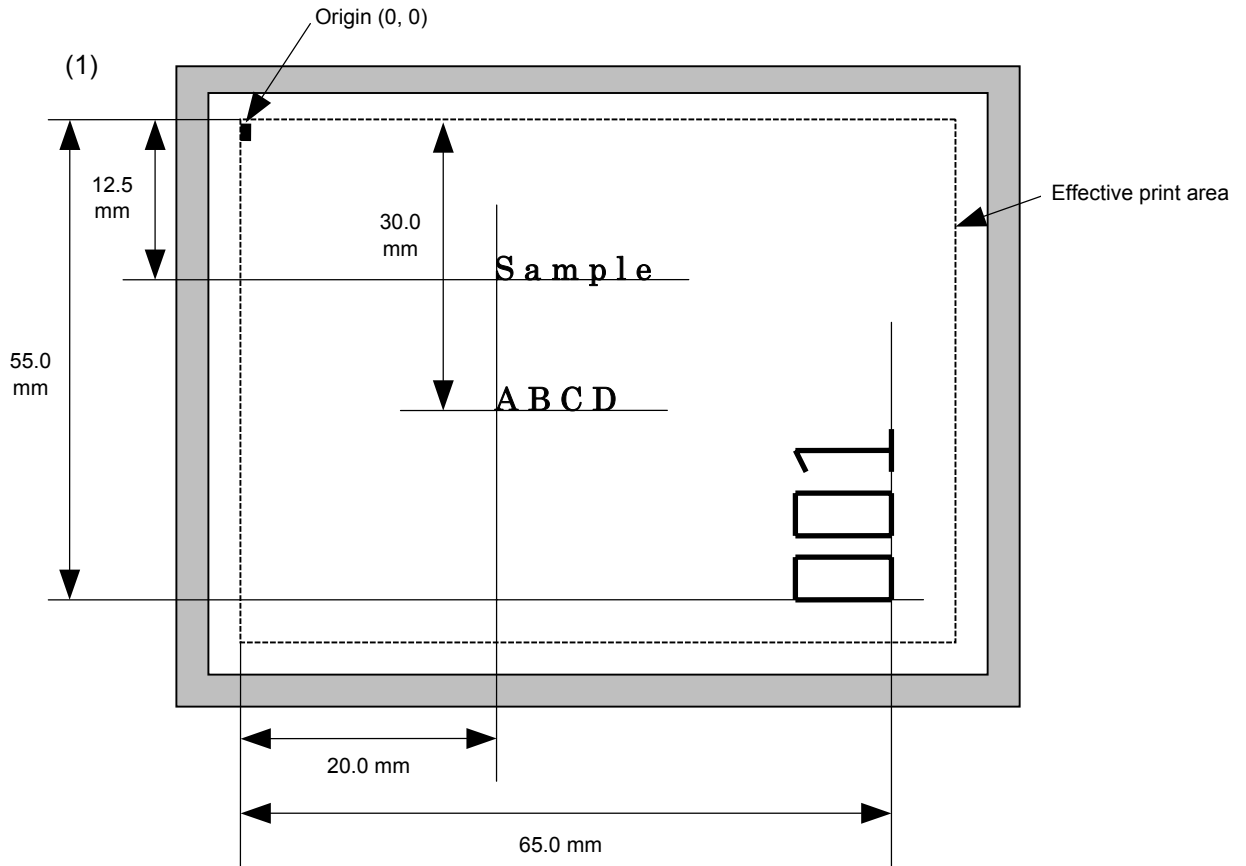

```
[ESC] C [LF] [NUL]
[ESC] PC000; 0200, 0300, 1, 1, A, 00, B=ABCD [LF] [NUL]
[ESC] PC001; 0200, 0125, 1, 1, C, 00, B [LF] [NUL]
[ESC] PC002; 0650, 0550, 2, 2, G, 33, B, +0000000001 [LF] [NUL]
[ESC] RC001; Sample [LF] [NUL]
[ESC] RC002; 001 [LF] [NUL]
[ESC] XS; I, 0002, 0002C3000 [LF] [NUL]
```

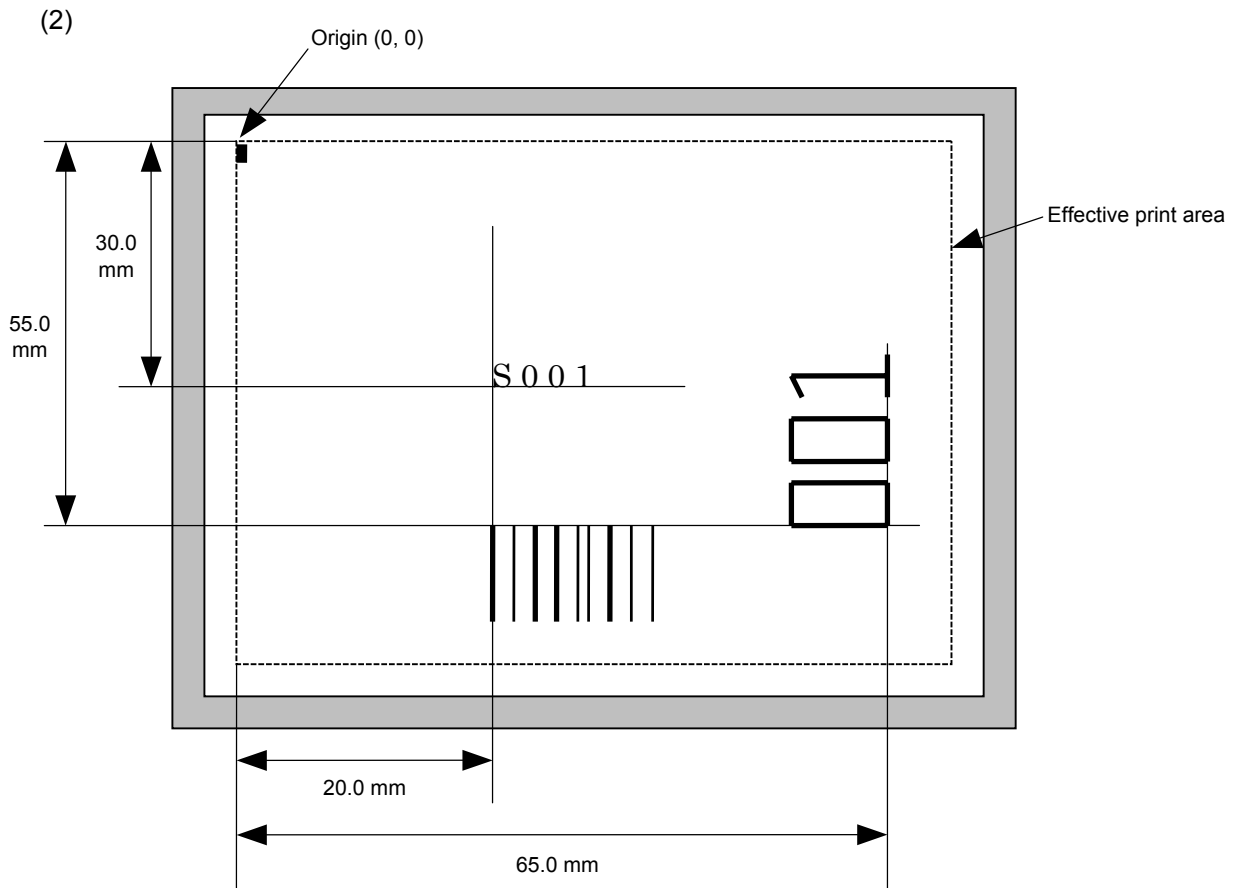

```
[ESC] C [LF] [NUL]
[ESC] PC001; 0200, 0300, 1, 1, C, 00, B; 01, 02 [LF] [NUL]
[ESC] PV01; 0650, 0550, 0200, 0150, B, 33, B; 02 [LF] [NUL]
[ESC] XB01; 0200, 0550, 3, 1, 03, 03, 08, 08, 03, 0, 0150; 01, 02 [LF] [NUL]
[ESC] RC; S [LF] 001 [LF] [NUL]
[ESC] XS; I, 0002, 0002C3000 [LF] [NUL]
```

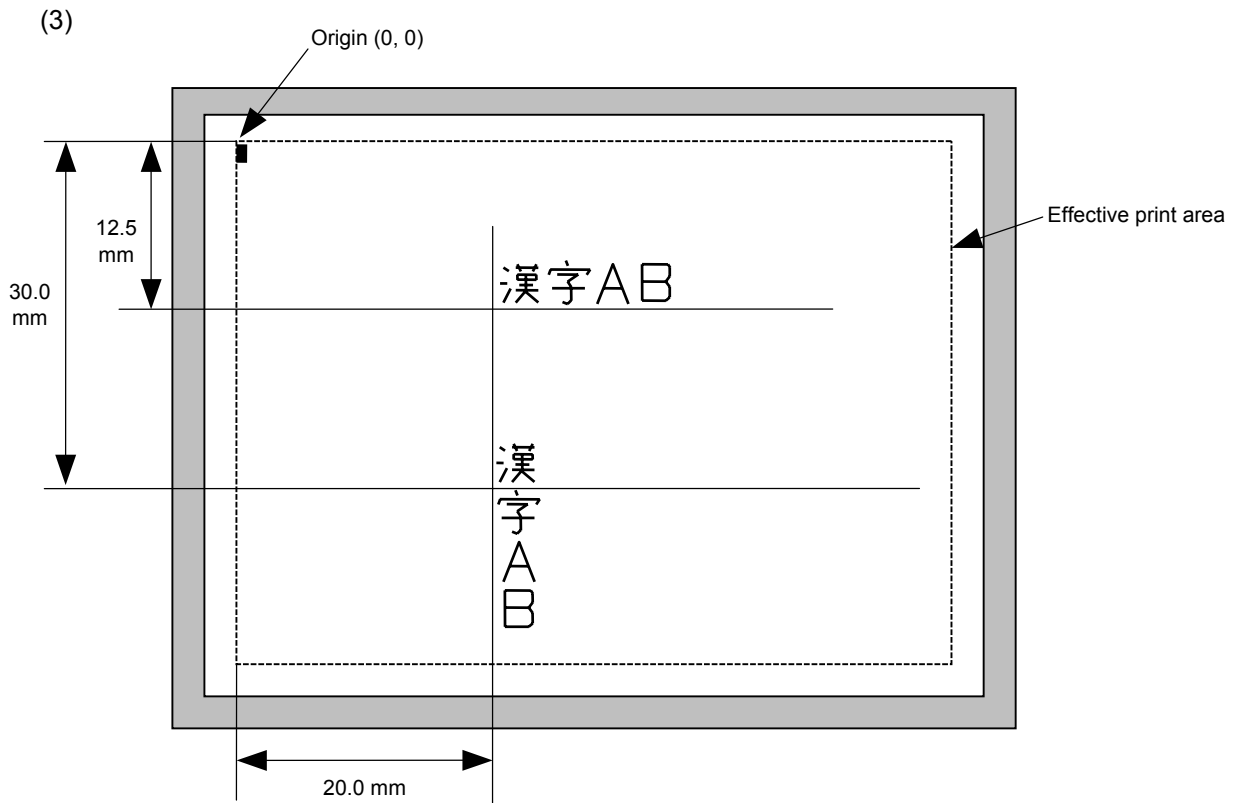

```
[ESC] C [LF] [NUL]
[ESC] PC000; 0200, 0125, 1, 1, W, 00, B [LF] [NUL]
[ESC] PC001; 0200, 0300, 1, 1, W, 01, B [LF] [NUL]
[ESC] RC000; 漢字 AB [LF] [NUL]
[ESC] RC001; 漢字 AB [LF] [NUL]
[ESC] XS; I, 0002, 0002C3000 [LF] [NUL]
```

6.3.9 OUTLINE FONT FORMAT COMMAND

[ESC] PV

Function	Sets the format to indicate the position on the label, at which the outline font is to be printed and how it is to be printed.
----------	--

⊙ Fonts other than TrueType font

Format	<p>① [ESC] PVaa; bbbb, cccc, dddd, eeee, f (, ghhh), ii, j (, Mk) (, Immmmmmmmmmm) (, Znn) (, Po) (=ppp-----ppp) [LF] [NUL]</p> <p>② [ESC] PVaa; bbbb, cccc, dddd, eeee, f (, ghhh), ii, j (, Mk) (, Immmmmmmmmmm) (, Znn) (, Po) (; qq₁, qq₂, qq₃, -----, qq₂₀) [LF] [NUL]</p>
--------	---

Term	<p>aa: Character string number 00 to 99</p> <p>bbbb: Print origin of X-coordinate of the character string Fixed as 4 digits (in 0.1 mm units)</p> <p>cccc: Print origin of Y-coordinate of the character string 4 or 5 digits (in 0.1 mm units)</p> <p>dddd: Character width 0020 to 0850 (in 0.1 mm units)</p> <p>eeee: Height of the character 0020 to 0850 (in 0.1 mm units)</p> <p>f: Type of font A: TEC FONT1 (Helvetica [bold]) B: TEC FONT1 (Helvetica [bold] proportional) E: Price Font 1 F: Price Font 2 G: Price Font 3 H: DUTCH801 Bold (Times Roman Proportional) I: BRUSH738 Regular (Pop Proportional) J: GOTHIC725 Black (Proportional)</p> <p>ghhh: Fine adjustment of character-to-character space (Omissible. If omitted, space is adjusted according to the designated font.) g: Designates whether to increase or decrease the character-to-character space. +: Increase -: Decrease</p> <p>hhh: No. of space dots between characters 000 to 512 (in dots)</p> <p>ii: Rotational angles of a character and character string 00: 0° (char.) 0° (char.-string) 11: 90° (char.) 90° (char.-string) 22: 180° (char.) 180° (char.-string) 33: 270° (char.) 270° (char.-string)</p>
------	--

- j: Character attribution
- B: Black character
 - W (aabb): Reverse character
 - aa: No. of dots from the character string to the end of the black background in the horizontal direction.
 - bb: No. of dots from the character string to the end of the black background in the vertical direction.
 - aa: 01 to 99 (in units of dots)
 - bb: 01 to 99 (in units of dots)
 - F (aabb): Boxed character
 - aa: No. of dots from the character string area to the box in the horizontal direction.
 - bb: No. of dots from the character string area to the box in the vertical direction.
 - aa: 01 to 99 (in units of dots)
 - bb: 01 to 99 (in units of dots)
 - C (aa): Stroked out character
 - aa: No. of dots from the character string area to the end of the stroke
 - aa: 01 to 99 (in units of dots)
- * Descriptions in parentheses are omissible.
 (If omitted, it is character size (the larger character width or height) ÷ 8 dots.)
- Mk: Type of the check digit to be attached
 (Omissible. If omitted, the check digit is not drawn.)
- k: Type of check digit
 - 0: Modulus 10 (Draws data and check digit)
 - 1: Modulus 43 (Draws data and check digit)
 - 2: DBP Modulus 10 (Draws check digit only)
- lmmmmmmmmmm: Increment and decrement
 (Omissible. If omitted, incrementing/decrementing is not performed.)
- l: Designates whether to increment or decrement.
 - +: Increment
 - : Decrement
 - mmmmmmmmmm: Skip value
 - 0000000000 to 9999999999
- Znn: Zero suppression
 (Omissible. If omitted, the zero suppression process is not performed.)
- nn: No. of zeros to be suppressed
 - 00 to 20

Po: Alignment (Omissible. If omitted, the alignment is set to the left.)
o: Designates the character position.
1: Left
2: Center
3: Right
4aaaa: Equal space
aaaa: X direction of character string area
0050 to 1040 (in 0.1 mm units)

ppp-----ppp: Data string to be printed (Omissible)
Max. 255 digits

qq₁, qq₂, qq₃, -----, qq₂₀: Link field No. (Omissible)
01 to 99 (1 to 99 can also be used.)
Up to 20 fields can be designated using commas.

⊙ TrueType font

Format	[ESC] PVaa; bbbb, cccc, dddd, eeee, ff, g (, hiii), jj, k (=ppp ----- ppp) [LF] [NUL]
--------	---

Term	<p>aa: Character string number 00 to 99</p> <p>bbbb: Print origin of X-coordinate of the character string Fixed as 4 digits (in 0.1 mm units)</p> <p>cccc: Print origin of Y-coordinate of the character string 4 or 5 digits (in 0.1 mm units)</p> <p>dddd: Character width 0020 to 0850 (in 0.1 mm units)</p> <p>eeee: Height of the character 0020 to 0850 (in 0.1 mm units)</p> <p>ff: Type of font</p> <ul style="list-style-type: none"> 01: BalloonPExtBol (File name: Ballp_eb.ttf) 02: BlacklightD (File name: Blklt_rg.ttf) 03: BrushScrD (File name: Brush_rg.ttf) 04: CG Times (File name: Tec_cgt.ttf) 05: CG Times Bold (File name: Tec_cgtb.ttf) 06: CG Times Italic (File name: Tec_cgti.ttf) 07: Clarendon Condensed Bold (File name: Tec_clcd.ttf) 08: FlashPBol (File name: Flash_bd.ttf) 09: Garamond Kursiv Halbfett (File name: Tec_gmkh.ttf) 10: GoudyHeaP (File name: Gdyhp_rg.ttf) 11: GilliesGotDBol (File name: Gilli_bd.ttf) 12: GilliesGotLig (File name: Gilli_lt.ttf) 13: NimbusSanNovTUItLigCon (File name: Nsnct_ul.ttf) 14: Ryahd (File name: ryahd.ttf) 15: Ryahd Bold (File name: ryahdbd.ttf) 16: CG Triumvirate (File name: Trium.ttf) 17: CG Triumvirate Condensed Bold (File name: Triumcb.ttf) 18: Univers Medium (File name: Tec_uni.ttf) 19: Univers Bold (File name: Tec_unib.ttf) 20: Univers Medium Italic (File name: Tec_unii.ttf) 21: add_on TrueTypeFont 1 (File name: addttf01.ttf) 22: add_on TrueTypeFont 2 (File name: addttf02.ttf) 23: add_on TrueTypeFont 3 (File name: addttf03.ttf) 24: add_on TrueTypeFont 4 (File name: addttf04.ttf) 25: add_on TrueTypeFont 5 (File name: addttf05.ttf)
------	---

(*1) The font types 21 to 25 are the fonts a user adds. These fonts can be used by specifying “addttf01.ttf” to “addttf05.ttf” for the file names and installing these in the ATA card.

(*2) For the fonts stored in flash ROM on the CPU board, parameter “ff” for the type of font corresponds to the font type according to the setting made when fonts are stored.

- g: Drive
Indicates where the TrueType font files are stored.
- 0: Flash ROM on the CPU board
 - 1: Slot 1 on the PCMCIA board (Option)
 - 2: Slot 2 on the PCMCIA board (Option)
- * "0" cannot be specified for the font types from 21 to 25.
- hiii: Fine adjustment of character-to-character space
(Omissible. If omitted, space is adjusted according to the designated font.)
- h: Designates whether to increase or decrease the character-to-character space.
 - +: Increase
 - : Decrease
 - iii: No. of space dots between characters
000 to 512 (in dots)
- jj: Rotational angles of a character and character string
- 00: 0° (char.) 0° (char.-string)
 - 11: 90° (char.) 90° (char.-string)
 - 22: 180° (char.) 180° (char.-string)
 - 33: 270° (char.) 270° (char.-string)
- k: Character attribution
B: Black character
- ppp-----ppp: Data string to be printed (Omissible)
Max. 255 digits

* TrueType fonts are not included in the standard character generator data. Therefore, they must be installed in flash ROM on the CPU board, or the ATA card.
For installation of TrueType font and details, refer to the TrueType Font Specification (TAA-1416).

* If Arabic is selected as the character code, letters are written from right to left.

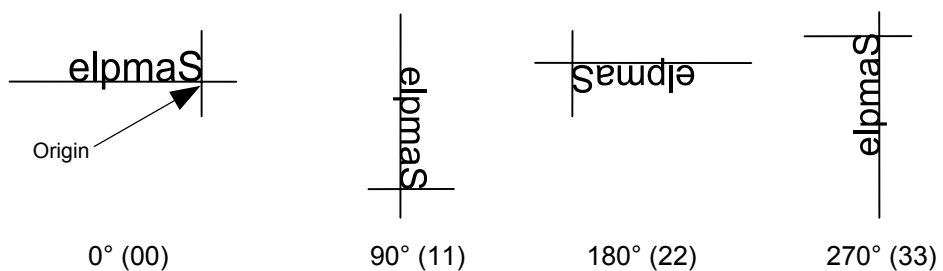

Explanation

(1) Character string number

When drawing by the Data Command ([ESC] RV), the format designated by the character string number is selected.

(2) Print origin of coordinates

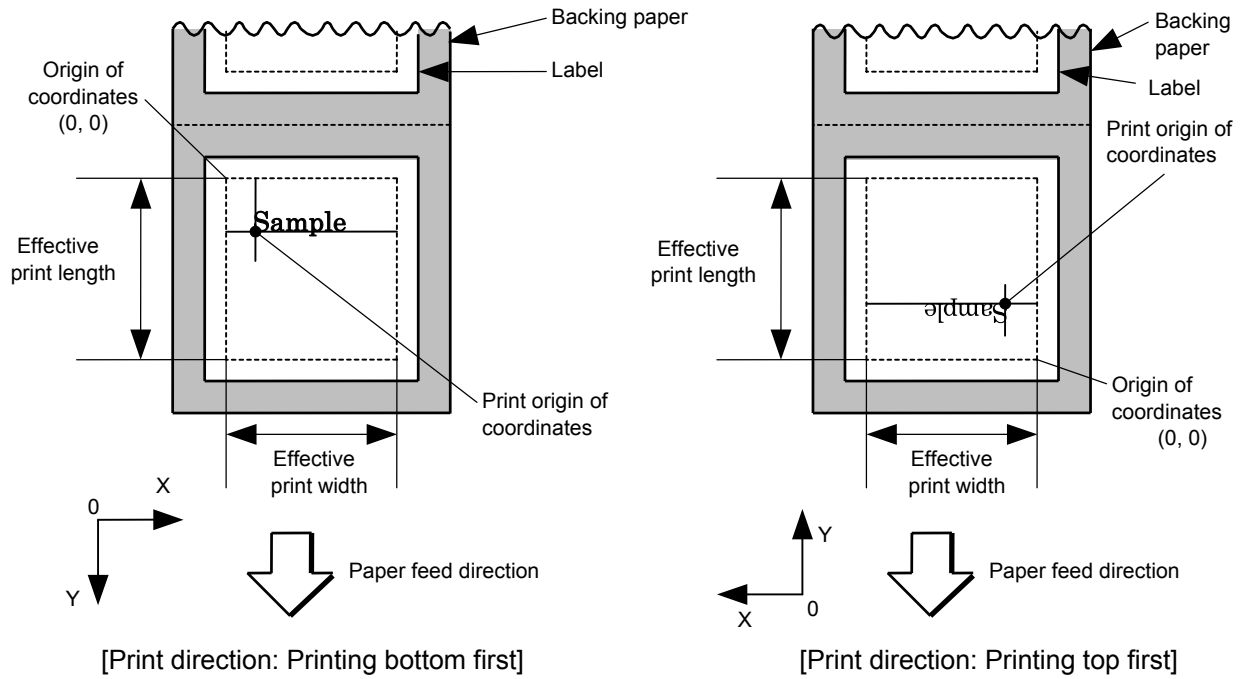

- The print origin of coordinates must be set so the character drawing result will be within the effective print area set by the Label Size Set Command ([ESC] D).

[Effective print area]

[mm]

Item		Model		Issue mode		B-SX4T					B-SX5T						
						Batch	Strip	Cut				Batch	Strip	Cut			
								Swing cutter	Rotary cutter		Swing cutter			Rotary cutter			
									Head-up operation not performed	Head-up operation performed				Head-up operation not performed	Head-up operation performed		
Effective print width		Min.	10.0					10.0									
		Max.	104.0					128.0									
Effective print length	Label	Min.	6.0	21.4	23.0	3 ips: 79.0	3 ips: 30.0	6.0	21.4	23.0	3 ips: 79.0	3 ips: 30.0					
						6 ips: 91.0	6 ips: 30.0				5 ips: 87.0	5 ips: 30.0					
						10 ips: – (NOTE 1)	10 ips: – (NOTE 1)				8 ips: 98.0	8 ips: 30.0					
						Max.					1496.0		1492.0		1496.0		1492.0
	Tag	Min.	8.0	–	23.4	3 ips: 28.0		8.0	–	23.4	3 ips: 28.0						
						6 ips: 28.0					5 ips: 28.0						
						10 ips: – (NOTE 1)					8 ips: 36.0						
						Max.					1498.0		1498.0		1498.0		1498.0

NOTE 1: The use of the rotary cutter at 10 ips is not supported for the B-SX4T.

(3) Character width and character height

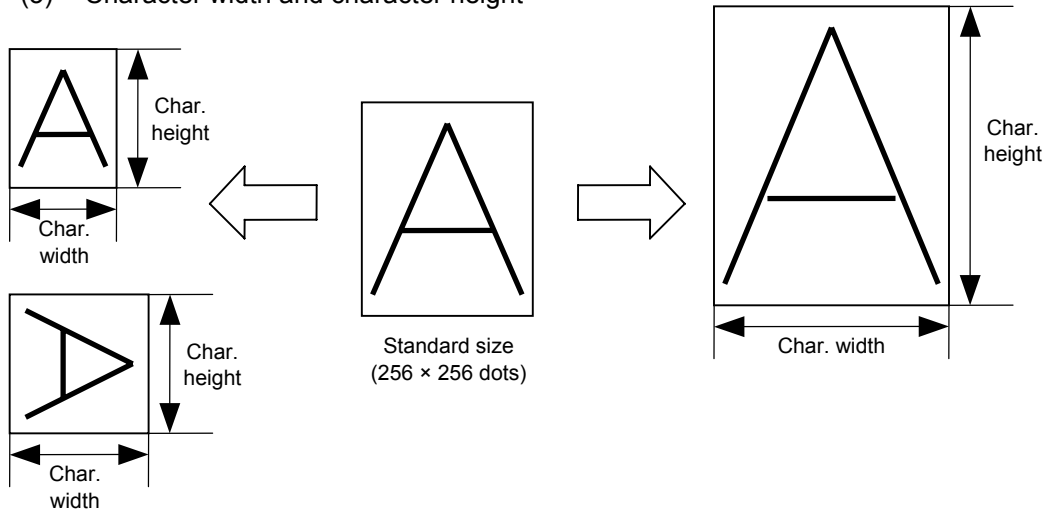

(4) Type of font

A: TEC FONT1 (Helvetica [bold])

**! " # \$ % & ' () * + , - . /
0 1 2 3 4 5 6 7 8 9 : ; < = > ?
@ A B C D E F G H I J K L M N O
' a b c d e f g h i j k l m n o
Ç ü é â ä à å ç ê ë è ì î ï Ä Å**

B: TEC FONT1 (Helvetica [bold] proportional)

**! " # \$ % & ' () * + , - . /
0 1 2 3 4 5 6 7 8 9 : ; < = > ?
@ A B C D E F G H I J K L M N O
' a b c d e f g h i j k l m n o
Ç ü é â ä à å ç ê ë è ì î ï Ä Å**

E: Price font 1 (POP font)

*\$ % , - . /
0 1 2 3 4 5 6 7 8 9
R y ~*

F: Price font 2 (POP font)

\$%, - . /

0 1 2 3 4 5 6 7 8 9

円 ¥ ~

G: Price font 3 (POP font)

\$%, - . /

0 1 2 3 4 5 6 7 8 9

円 ¥ ~

H: DUTCH801 Bold (Times Roman Proportional)

! " # \$ % & ' () * + , - . /

0 1 2 3 4 5 6 7 8 9 : ; < = > ?

@ A B C D E F G H I J K L M N O

` a b c d e f g h i j k l m n o

Ç ü é â ä å ç è ë ì ï Æ Å

É æ Æ ô ö ò û ù ÿ Ö Ü ø £ Ø × f

I: BRUSH 738 Regular (Pop Proportional)

!"#\$%&'()*+,-./
0123456789:;<=>?
@ABCDEFGHIJKLMNO
`abcdefghijklmno
ÇüéâäàåçêëèïîËÄ
ÉæÆôöòûùÿÖÜø&Ø×f

J: GOTHIC725 Black

!"#\$%&'()*+,-./
0123456789:;<=>?
@ABCDEFGHIJKLMNO
`abcdefghijklmno
ÇüéâäàåçêëèïîËÄ
ÉæÆôöòûùÿÖÜø&Ø×f

(5) Fine adjustment of character-to-character space

If no character-to-character space is specified or the number of space dots between characters is 0, drawing will take place according to the horizontal spacing/proportional spacing determined for each character. If character-to-character space is specified, drawing will take place according to the value obtained by adding the character spacing/proportional spacing to the specified value. When equal space is selected for the alignment, the character-to-character space setting is invalid. (The horizontal spacing/proportional spacing are increased or decreased depending on the character size.)

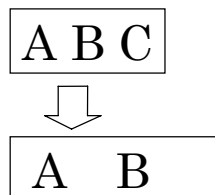

(6) Rotational angles of a character and character string

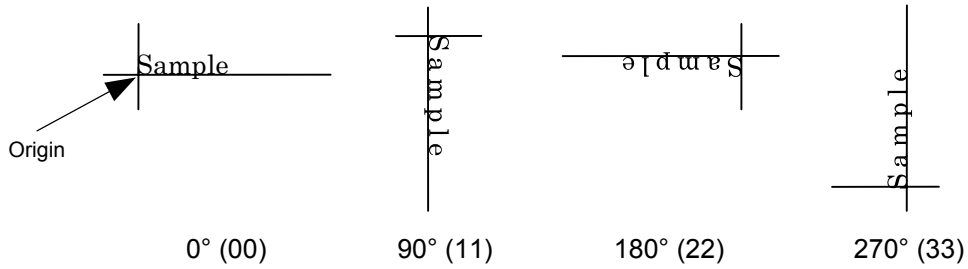

(7) Selection of character attribution

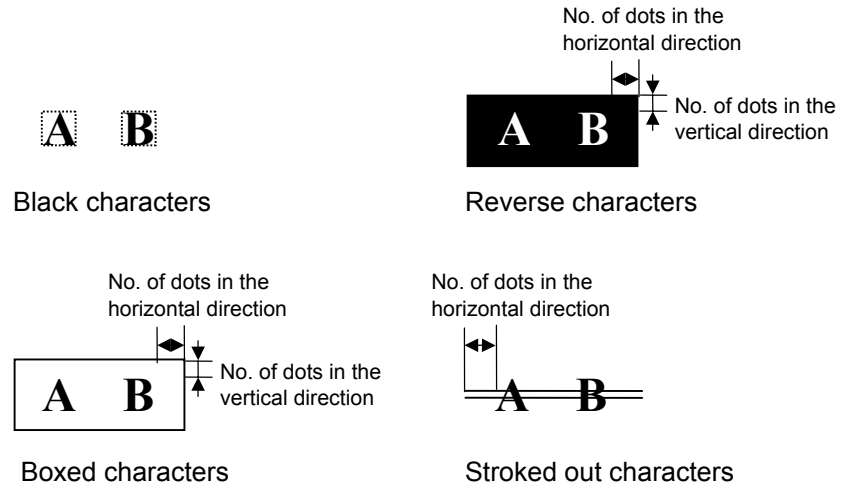

(8) Check digit to be attached

When Modulus 10 or Modulus 43 is selected, the check digit of a data row is calculated and attached to the data row for drawing. When modulus 10 is designated and the data includes any data other than the numerals, the data row will not be drawn. When modulus 43 is designated and the data includes any character other than CODE39, the drawing is not performed.

When DBP Modulus 10 is selected, the check digit of a data row is calculated and only the check digit is drawn. When the data includes any data other than the numerals, drawing is not performed.

* DBP Modulus 10 is Modulus 10 for Deutsche Bundespost Postdienst only.

(9) Increment/decrement

Printing is performed while the data is incremented or decremented each time a label is issued. Where the data row exceeds the maximum number of digits (40), the data row will not be drawn.

Initial value	0000	0000	0000	0000	999999
INC/DEC	+10	+10	+10	+10	+1
Zero suppression	Not designated	5	3	0	3
1st label	0000	0000	└000	0000	999999
2nd label	0010	0010	└010	0010	└└└000
3rd label	0020	0020	└020	0020	└└└001
4th label	0030	0030	└030	0030	└└└002
5th label	0040	0040	└040	0040	└└└003

Letters and numerals for increment/decrement

For the data string, up to 40 digits (including letters, numerals, and symbols) are possible. Only the numerals are selected and calculated for incrementing/decrementing, and then are returned to the previous position to draw the data.

Example of increment/decrement calculation

Initial value	00000	A0A0A	7A8/9	A2A0A
INC/DEC	+1	+1	+3	-3
1st label	00000	A0A0A	7A8/9	A2A0A
2nd label	00001	A0A1A	7A9/2	A1A7A
3rd label	00002	A0A2A	7A9/5	A1A4A
4th label	00003	A0A3A	7A9/8	A1A1A
5th label	00004	A0A4A	8A0/1	A0A8A

(10) Zero suppression

No. of zeros to be suppressed	0	1	2	2	3	4	5
Data	0000	0000	0000	0A12	0123	0123	0123
Print	0000	└└└0	└└00	└A12	└123	0123	0123

The leading zero(s) in a data row is replaced by a space(s) according to the designated number of digits. However, if the number of digits to be suppressed is greater than the data row, the data row will be drawn without zero suppression. Where the data row exceeds the maximum number of digits (40), the data row will not be drawn.

(11) Alignment

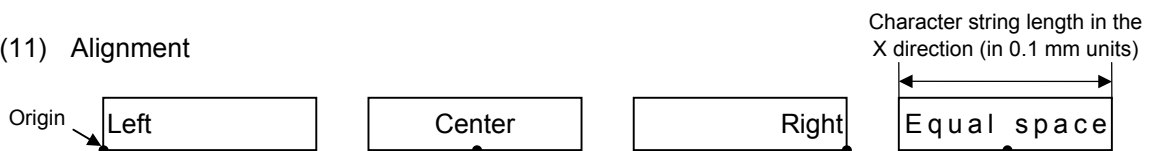

If characters are not placed on one line when equal space is designated, the width is calculated automatically. When the width is less than the limit value (2 mm) for the outline font, the field is not drawn. (The same previous field is not drawn.)

(12) Data string to be printed

Drawing data can be programmed by designating the number of digits after the symbol “=” Up to 255 digits can be printed. When the number of digits exceeds the maximum value, the excessive data will be discarded. For the character code table, refer to chapter 12 “CHARACTER CODE TABLE”.

(13) Link field No.

The link field No. can be programmed by designating it after the symbol “;.” After the link field No. is designated using the Format Command, the data strings are linked by the Link Field Data Command to draw an image.

Up to 20 fields can be linked.

The following shows an example of linked fields on the two continuous labels.

[Format Command]

[ESC] PV01; ; 01 [LF] [NUL] : Link field No. 1 is designated.
 [ESC] PV02; ; 03 [LF] [NUL] : Link field No. 3 is designated.
 [ESC] PV03; ; 04 [LF] [NUL] : Link field No. 4 is designated.
 [ESC] XB01; ; 03, 04 [LF] [NUL] : Link fields No. 3 and No. 4 are designated.

[ESC] PV04; ; 02 [LF] [NUL] : Link field No. 2 is designated.
 [ESC] PV05; ; 03 [LF] [NUL] : Link field No. 3 is designated.
 [ESC] PV06; ; 04 [LF] [NUL] : Link field No. 4 is designated.
 [ESC] XB02; ; 03, 04 [LF] [NUL] : Link fields No. 3 and No. 4 are designated.

Designating the link field No.

[Data Command]

[ESC] RV; A [LF] B [LF] ABCD [LF] 001 [LF] [NUL]

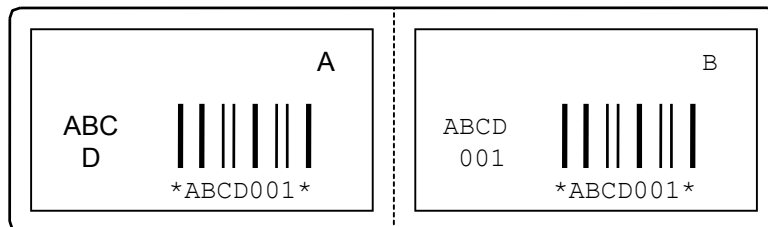
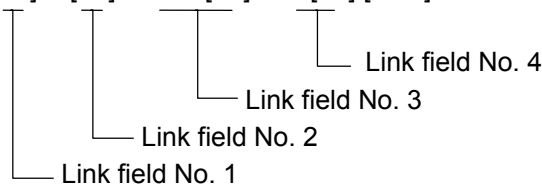

Notes

(1) The check digit attachment, increment/decrement, and zero suppress processes are performed according to the following priority. If any of the conditions are improper, no drawing will take place.

[For example, the zero(s) is replaced by a space(s) as a result of zero suppression but the modulus 10 designated to be attached cannot be calculated.]

Increment/decrement > zero suppression > attachment of check digit

(2) Up to 32 fields for which incrementing/decrementing has been designated can be drawn. If the total bit map font, outline font, and bar code increment/decrement fields exceeds 32, drawing will take place without incrementing/decrementing any excessive field. The field to be incremented or decremented is incremented or decremented until the Image Buffer Clear Command ([ESC] C) is transmitted.

[Examples]

- 1) Format Command (Increment character string No. 01 (+1))
- 2) Format Command (No incrementing for character string No. 02)
- 3) Format Command (Increment character string No. 03 (+2))
- 4) Image Buffer Clear Command
- 5) Data Command (Character string No. 01 "0001")
- 6) Data Command (Character string No. 02 "AB-")
- 7) Data Command (Character string No. 03 "0100")
- 8) Issue Command (2 labels)

0001
AB-0100

0002
AB-0102

- 9) Issue Command (1 label)

0003
AB-0104

- 10) Image Buffer Clear Command
- 11) Data Command (Character string No. 02 "00000")
- 12) Issue Command (1 label)

00000

- (3) The Outline Font Format Command may be connected to the Bit Map Font Format Command when transmitted.

[ESC] PC001; 0100, 0150, 1, 1, A, 00, B [LF]

C002; 0350, 0180, 1, 1, A, 00, B [LF]

C005; 0200, 0300, 25, 2, C, +05, 00, B, +0000000001 [LF]

V01; 0500, 0400, 0100, 0100, A, 00, B [LF] [NUL]

- (4) When the drawing data is changed per label issue during printing, the drawing data field for the previous label is automatically cleared using the character string number, then the next drawing data is printed. Therefore, the character string number which differs according to the drawing fields should be designated. Since the automatic field clear is not performed between the Clear Command ([ESC] C) and Issue Command ([ESC] XS), the fixed data may be drawn using the same character string number. In this case, the Format Command and Data Command should be sent alternately. (After the Issue Command is sent, the fields with the same character string number are automatically cleared until the Clear Command is sent.)
- (5) When characters overlap due to the character-to-character space fine adjustment, the outline font is not painted properly. Program the fine adjustment value so that characters will not overlap. Also, when drawings such as lines or characters are on the outline font drawing position, the outline font is not painted properly. For font types A and B, the fine adjustment value should be set so that other drawings do not overlap the area in which the outline font is to be drawn. For font types E, F and G, the fine adjustment value should be set so that other drawings do not overlap the area for the designated character width and height.
- (6) The link field designation can be cleared by omitting the link field designation using the same character string No. and reformatting data.
The link field designation can also be cleared by the Image Buffer Clear Command.
- (7) A print data string and the link field No. cannot be programmed at the same time.

Refer to

Outline Font Data Command ([ESC] RV)
Bit Map Font Format Command ([ESC] PC)
Bar Code Format Command ([ESC] XB)

Examples

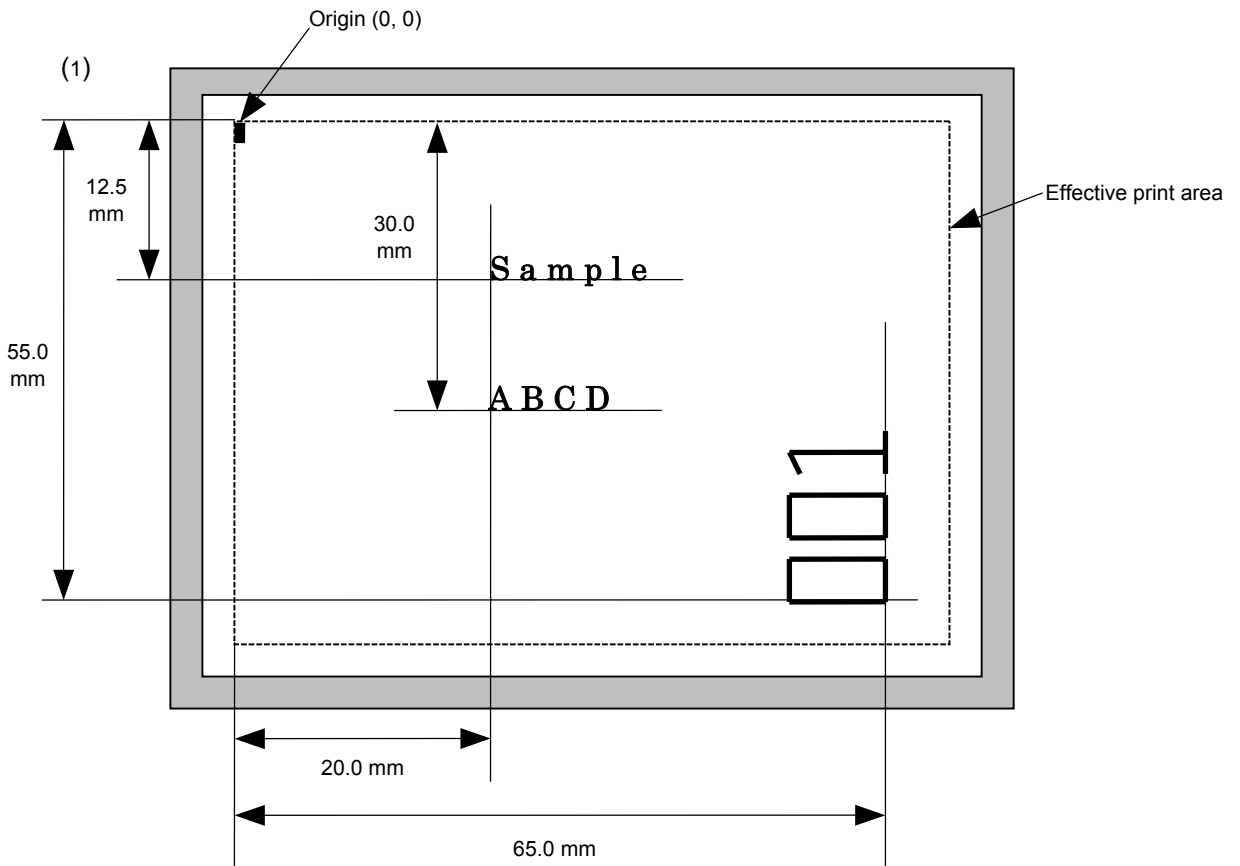

```
[ESC] C [LF] [NUL]
[ESC] PV00; 0200, 0300, 0080, 0080, B, 00, B=ABCD [LF] [NUL]
[ESC] PV01; 0200, 0125, 0100, 0100, B, 00, B [LF] [NUL]
[ESC] PV02; 0650, 0550, 0200, 0150, B, 33, B, +0000000001 [LF] [NUL]
[ESC] RV01; Sample [LF] [NUL]
[ESC] RV02; 001 [LF] [NUL]
[ESC] XS; I, 0002, 0002C3000 [LF] [NUL]
```

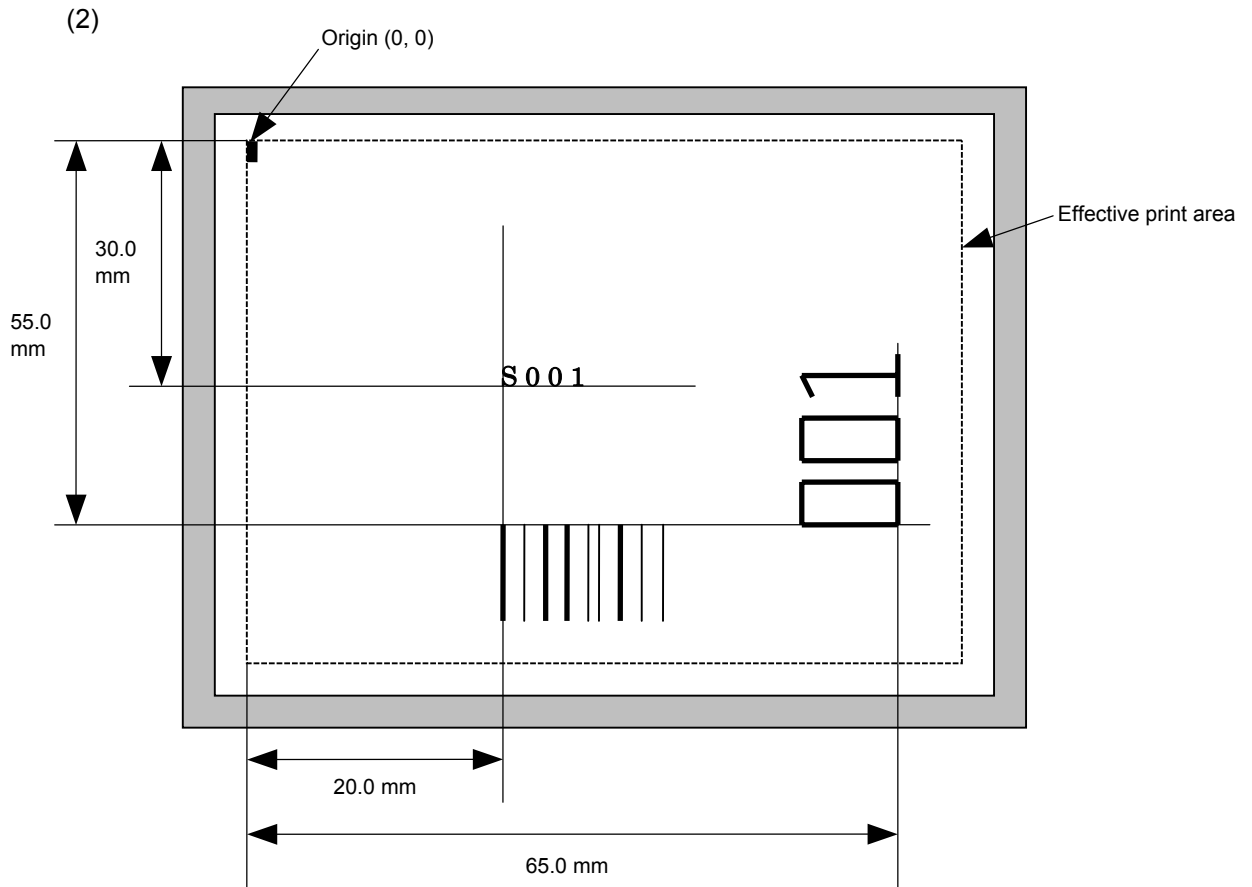

```
[ESC] C [LF] [NUL]
[ESC] PC001; 0200, 0300, 1, 1, C, 00, B; 01, 02 [LF] [NUL]
[ESC] PV01; 0650, 0550, 0200, 0150, B, 33, B; 02 [LF] [NUL]
[ESC] XB01; 0200, 0550, 3, 1, 03, 03, 08, 08, 03, 0, 0150; 01, 02 [LF] [NUL]
[ESC] RV; S [LF] 001 [LF] [NUL]
[ESC] XS; I, 0002, 0002C3000 [LF] [NUL]
```

6.3.10 BAR CODE FORMAT COMMAND

[ESC] XB

Function	Sets the format to indicate the position on the label, at which the bar code is to be printed and how it is to be printed.
----------	--

⊙ In the case of WPC, CODE93, CODE128, UCC/EAN128, Customer bar code, POSTNET, RM4SCC, KIX CODE
(WPC is the generic name for bar codes of JAN, EAN and UPC.)

Format	① [ESC] XBaa; bbbb, cccc, d, e, ff, k, llll (, mnnnnnnnnnn, ooo, p, qq) (= sss ----- sss) [LF] [NUL] ② [ESC] XBaa; bbbb, cccc, d, e, ff, k, llll (, mnnnnnnnnnn, ooo, p, qq) (; tt ₁ , tt ₂ , tt ₃ , -----, tt ₂₀) [LF] [NUL]
--------	---

Term	aa: Bar code number 00 to 31 bbbb: Print origin of X-coordinate of the bar code Fixed as 4 digits (in 0.1 mm units) cccc: Print origin of Y-coordinate of the bar code 4 or 5 digits (in 0.1 mm units) d: Type of bar code 0: JAN8, EAN8 5: JAN13, EAN13 6: UPC-E 7: EAN13 + 2 digits 8: EAN13 + 5 digits 9: CODE128 (with auto code selection) A: CODE128 (without auto code selection) C: CODE93 G: UPC-E + 2 digits H: UPC-E + 5 digits I: EAN8 + 2 digits J: EAN8 + 5 digits K: UPC-A L: UPC-A + 2 digits M: UPC-A + 5 digits N: UCC/EAN128 R: Customer bar code (Postal code for Japan) S: Highest priority customer bar code (Postal code for Japan) U: POSTNET (Postal code for U.S) V: RM4SCC (ROYAL MAIL 4 STATE CUSTOMER CODE) (Postal code for U.K) W: KIX CODE (Postal code for Belgium)
------	--

- e: Type of check digit
- 1: Without attaching check digit
 - 2: Check digit check

WPC	Modulus 10
CODE93	Modulus 47
CODE128	PSEUDO 103
 - 3: Check digit auto attachment (1)

WPC	Modulus 10
CODE93	Modulus 47
CODE128	PSEUDO 103
UCC/EAN128	Modulus 10 + Modulus 103
Customer code	Special check digit
POSTNET	Special check digit
RM4SCC	Special check digit
 - 4: Check digit auto attachment (2)

WPC	Modulus 10 + Price C/D 4 digits
-----	---------------------------------
 - 5: Check digit auto attachment (3)

WPC	Modulus 10 + Price C/D 5 digits
-----	---------------------------------

* For the Customer bar code, POSTNET, and RMC4SCC, only "3: Check digit auto attachment (1)" is effective.
- ff: 1-module width
01 to 15 (in dots)
- k: Rotational angle of bar code
- 0: 0°
 - 1: 90°
 - 2: 180°
 - 3: 270°
- lll: Height of the bar code
0000 to 1000 (in 0.1 mm units)
For the Customer bar code, POSTNET, RMC4SCC, KIX CODE, the height of the long bar is specified.
- mnnnnnnnnn: Increment/decrement
(Omissible. If omitted, incrementing/decrementing is not performed.)
- m: Indicates whether to increment or decrement
- +: Increment
 - : Decrement
- nnnnnnnnnn: Skip value
0000000000 to 9999999999
- ooo: Length of WPC guard bar
(Omissible. If omitted, the guard bar is not attached.)
000 to 100 (in 0.1 mm units)
- p: Selection of print or non-print of numerals under bars
(Omissible. If omitted, the numerals under the bars are not printed.)
- 0: Non-print
 - 1: Print

qq: No. of zeros to be suppressed
(Omissible. If omitted, the zero suppression process is not performed.)
00 to 20

sss ----- sss: Data string to be printed (Omissible)
Max. 126 digits. However, it varies depending on the type of bar code.

tt₁, tt₂, tt₃, -----, tt₂₀: Link field No. (Omissible)
01 to 99 (1 to 99 can also be used.)
Up to 20 fields can be designated using commas.

* Omissible parameters (such as "Increment/decrement", "Selection of print or non-print of numerals under bars" and "No. of zeros to be suppressed") cannot be set when the postal code (Customer bar code, POSTNET, RM4SCC, KIX CODE) is selected.

⊙ In the case of MSI, Interleaved 2 of 5, CODE39, NW7, Industrial 2 of 5, MATRIX 2 of 5 for NEC

- | | |
|--------|--|
| Format | ① [ESC] XBaa; bbbb, cccc, d, e, ff, gg, hh, ii, jj, k, llll (, mnnnnnnnnnn, p, qq) (, r) (=sss-----sss) [LF] [NUL] |
| | ② [ESC] XBaa; bbbb, cccc, d, e, ff, gg, hh, ii, jj, k, llll (, mnnnnnnnnnn, p, qq) (, r) (; tt ₁ , tt ₂ , tt ₃ , -----, tt ₂₀) [LF] [NUL] |

- | | |
|------|--|
| Term | aa: Bar code number
00 to 31 |
| | bbbb: Print origin of X-coordinate of the bar code
Fixed as 4 digits (in 0.1 mm units) |
| | cccc: Print origin of Y-coordinate of the bar code
4 or 5 digits (in 0.1 mm units) |
| | d: Type of bar code
1: MSI
2: Interleaved 2 of 5 (ITF)
3: CODE39 (standard)
4: NW7
B: CODE39 (full ASCII)
O: Industrial 2 of 5
a: MATRIX 2 of 5 for NEC |
| | e: Type of check digit
1: Without attaching check digit
2: Check digit check
CODE39 Modulus 43
MSI IBM modulus 10
ITF Modulus 10
Industrial 2 of 5 Modulus check character
MATRIX 2 of 5 for NEC Modulus check character
3: Check digit auto attachment (1)
CODE39 Modulus 43
MSI IBM modulus 10
ITF Modulus 10
Industrial 2 of 5 Modulus check character
MATRIX 2 of 5 for NEC Modulus check character
4: Check digit auto attachment (2)
MSI IBM modulus 10 + IBM modulus 10
ITF DBP Modulus 10
5: Check digit auto attachment (3)
MSI IBM modulus 11 + IBM modulus 10 |
| | ff: Narrow bar width
01 to 99 (in dots) |
| | gg: Narrow space width
01 to 99 (in dots)

* In the case of industrial 2 of 5, an element-to-element space is designated. |
| | hh: Wide bar width
01 to 99 (in dots) |

- ii: Wide space width
01 to 99 (in dots)
* In the case of industrial 2 of 5, the value is fixed to 00.
- jj: Character-to-character space width
01 to 99 (in dots)
* In the case of MSI and ITF, character-to-character space width is set to 00.
- k: Rotational angle of bar code
0: 0°
1: 90°
2: 180°
3: 270°
- lll: Height of the bar code
0000 to 1000 (in 0.1 mm units)
- nnnnnnnnnn: Increment/decrement
(Omissible. If omitted, incrementing/decrementing is not performed.)
m: Indicates whether to increment or decrement
+: Increment
-: Decrement
- nnnnnnnnnn: Skip value
0000000000 to 9999999999
- p: Selection of print or non-print of numerals under bars
(Omissible. If omitted, the numerals under the bars are not printed.)
0: Non-print
1: Print
- qq: No. of zeros to be suppressed
(Omissible. If omitted, the zero suppression process is not performed.)
00 to 20
- r: Designates the attachment of start/stop code
(Omissible. If omitted, the start/stop code is automatically attached.)
T: Attachment of start code only
P: Attachment of stop code only
N: Start/stop code unattached
- sss-----sss: Data string to be printed (Omissible)
Max. 126 digits. However, the number of digits varies depending on the type of bar code.
- tt₁, tt₂, tt₃, -----, tt₂₀: Link field No. (Omissible)
01 to 99 (1 to 99 can also be used.)
Up to 20 fields can be designated using commas.

⊙ In the case of RSS (Reduced Space Symbology)

Format	
	① [ESC] XBaa; bbbb, cccc, d, e, ff, g, hhhh (, ijzzzzzzzz, kk) (= sss ----- sss) [LF] [NUL]
	② [ESC] XBaa; bbbb, cccc, d, e, ff, g, hhhh (, ijzzzzzzzz, kk) (; tt ₁ , tt ₂ , tt ₃ , -----, tt ₂₀) [LF] [NUL]

Term	
aa:	Bar code number 00 to 31
bbbb:	Print origin of X-coordinate of the bar code Fixed as 4 digits (in 0.1 mm units)
cccc:	Print origin of Y-coordinate of the bar code 4 or 5 digits (in 0.1 mm units)
d:	Type of bar code b: RSS family
e:	Version (Type of RSS) 1: RSS-14 2: RSS-14 Stacked 3: RSS-14 Stacked Omnidirectional 4: RSS Limited 5: RSS Expanded
ff:	1-module width 01 to 15 (in dots)
g:	Rotational angle of bar code 0: 0° 1: 90° 2: 180° 3: 270°
hhhh:	Height of the bar code 0000 to 1000 (in 0.1 mm units)
ijzzzzzzzz:	Increment/decrement (Omissible. If omitted, incrementing/decrementing is not performed.) i: Indicates whether to increment or decrement +: Increment -: Decrement
jjzzzzzzzz:	Skip value 0000000000 to 9999999999
kk:	No. of zeros to be suppressed (Omissible. If omitted, the zero suppression process is not performed.) 00 to 20
sss ----- sss:	Data string to be printed (Omissible) Max. 126 digits. However, it varies depending on the type of bar code.
tt ₁ , tt ₂ , tt ₃ , -----, tt ₂₀ :	Link field No. (Omissible) 01 to 99 (1 to 99 can also be used.) Up to 20 fields can be designated using commas.

⊙ In the case of Data Matrix (Two-dimensional code)

Format	
	① [ESC] XBaa; bbbb, cccc, d, ee, ff, gg, h (, Ciiijj) (, Jkklmmnnn) (= ooo -----ooo) [LF] [NUL]
	② [ESC] XBaa; bbbb, cccc, d, ee, ff, gg, h (, Ciiijj) (, Jkklmmnnn) (; pp ₁ , pp ₂ , pp ₃ , -----, pp ₂₀) [LF] [NUL]

Term	
aa:	Bar code number 00 to 31
bbbb:	Print origin of X-coordinate of the bar code Fixed as 4 digits (in 0.1 mm units)
cccc:	Print origin of Y-coordinate of the bar code 4 or 5 digits (in 0.1 mm units)
d:	Type of bar code Q: Data Matrix (Two-dimensional code)
ee:	ECC type 00: ECC0 01: ECC50 04: ECC50 05: ECC50 06: ECC80 07: ECC80 08: ECC80 09: ECC100 10: ECC100 11: ECC140 12: ECC140 13: ECC140 14: ECC140 20: ECC200
ff:	1-cell width 00 to 99 (in dots)
gg:	Format ID 01: Format ID 1 02: Format ID 2 03: Format ID 3 04: Format ID 4 05: Format ID 5 06: Format ID 6

* When ECC200 is designated as ECC type, the format ID designation is ignored. When format ID of 11 through 16 is designated, the selection of ECC200 is compulsory (to ensure compatibility with the old model).

h: Rotational angle of bar code

- 0: 0°
- 1: 90°
- 2: 180°
- 3: 270°

Ciiijj: No. of cells

(Omissible. If omitted, it is automatically set.)

iii: No. of cells in the X direction 000 to 144

jjj: No. of cells in the Y direction 000 to 144

* Cell setting varies according to the ECC type.

	ECC0 to ECC140	ECC200
No. of cells to be designated	Odd numbers only	Even numbers only
Min./Max. No. of cells	9 × 9 to 49 × 49	10 × 10 to 144 × 144
Rectangular code	None	18 × 8 32 × 8 26 × 12 36 × 12 36 × 16 48 × 16

- When this parameter is omitted, the number of cells is automatically set. Also, when any data other than the above values are designated for the number of cells in the X and Y directions, the number of cells are automatically set.

Jkkllmmnnn: Connection setting

(Omissible. No connection if this parameter is omitted.)

kk: Code number 01 to 16

ll: No. of divided codes 02 to 16

mmm: ID number 1 001 to 254

nnn: ID number 2 001 to 254

ooo ----- ooo: Data string to be printed (Omissible)

Max. 2000 digits.

pp₁, pp₂, pp₃, -----, pp₂₀: Link field No. (Omissible)

01 to 99 (1 to 99 can also be used.)

Up to 20 fields can be designated using commas.

⊙ In the case of PDF417 (Two-dimensional code)

Format	
	① [ESC] XBaa; bbbb, cccc, d, ee, ff, gg, h, iiii (=jjj-----jjj) [LF] [NUL]
	② [ESC] XBaa; bbbb, cccc, d, ee, ff, gg, h, iiii (; kk ₁ , kk ₂ , kk ₃ , -----, kk ₂₀) [LF] [NUL]
Term	
aa:	Bar code number 00 to 31
bbbb:	Print origin of X-coordinate of the bar code Fixed as 4 digits (in 0.1 mm units)
cccc:	Print origin of Y-coordinate of the bar code 4 or 5 digits (in 0.1 mm units)
d:	Type of bar code P: PDF417 (Two-dimensional code)
ee:	Security level
	00: Level 0
	01: Level 1
	02: Level 2
	03: Level 3
	04: Level 4
	05: Level 5
	06: Level 6
	07: Level 7
	08: Level 8
ff:	1-module width 01 to 10 (in dots)
gg:	No. of columns (strings) 01 to 30
h:	Rotational angle of bar code
	0: 0°
	1: 90°
	2: 180°
	3: 270°
iiii:	Bar height 0000 to 0100 (in 0.1 mm units)
jjj-----jjj:	Data string to be printed (Omissible) Max. 2,000 digits
kk ₁ , kk ₂ , kk ₃ , -----, kk ₂₀ :	Link field No. (Omissible) 01 to 99 (1 to 99 can also be used.) Up to 20 fields can be designated using commas.

⊙ In the case of MicroPDF417 (Two-dimensional code)

Format	
	① [ESC] XBaa; bbbb, cccc, d, ee, ff, gg, h, iiiii (=jjj-----jjj) [LF] [NUL]
	② [ESC] XBaa; bbbb, cccc, d, ee, ff, gg, h, iiiii (; kk ₁ , kk ₂ , kk ₃ , -----, kk ₂₀) [LF] [NUL]
Term	
aa:	Bar code number 00 to 31
bbbb:	Print origin of X-coordinate of the bar code Fixed as 4 digits (in 0.1 mm units)
cccc:	Print origin of Y-coordinate of the bar code 4 or 5 digits (in 0.1 mm units)
d:	Type of bar code X: MicroPDF417 (Two-dimensional code)
ee:	Security level 00: Fixed
ff:	1-module width 01 to 10 (in dots)
gg:	No. of columns/rows 00 to 38
h:	Rotational angle of bar code 0: 0° 1: 90° 2: 180° 3: 270°
iiii:	Bar height 0000 to 0100 (in 0.1 mm units)
jjj-----jjj:	Data string to be printed (Omissible) Max. 366 digits
kk ₁ , kk ₂ , kk ₃ , -----, kk ₂₀ :	Link field No. (Omissible) 01 to 99 (1 to 99 can also be used.) Up to 20 fields can be designated using commas.

The maximum number of columns and rows for the MicroPDF417

Parameter (gg)	No. of columns	No. of rows	Max. number of digits for binary mode	Max. number of digits for upper case letter/space mode	Max. number of digits for numeric mode
00	–	–	150	250	366
01	1	–	22	38	55
02	2	–	43	72	105
03	3	–	97	162	237
04	4	–	150	250	366
05	1	11	3	6	8
06		14	7	12	17
07		17	10	18	26
08		20	13	22	32
09		24	18	30	44
10		28	22	38	55
11	2	8	8	14	20
12		11	14	24	35
13		14	21	36	52
14		17	27	46	67
15		20	33	56	82
16		23	38	64	93
17		26	43	72	105
18	3	6	6	10	14
19		8	10	18	26
20		10	15	26	38
21		12	20	34	49
22		15	27	46	67
23		20	39	66	96
24		26	54	90	132
25		32	68	114	167
26		38	82	138	202
27		44	97	162	237
28	4	4	8	14	20
29		6	13	22	32
30		8	20	34	49
31		10	27	46	67
32		12	34	58	85
33		15	45	76	111
34		20	63	106	155
35		26	85	142	208
36		32	106	178	261
37		38	128	214	313
38		44	150	250	366

“–” for parameter 00 to 04 indicates the numbers of columns/rows which are automatically set by the printer. In this case, the pattern which has a smaller number of code words is automatically selected. When the numbers of code words is equal, the smaller number of columns are selected.

⊙ In the case of QR code (Two-dimensional code)

Format	<p>① [ESC] XBaa; bbbb, cccc, d, e, ff, g, h (, Mi) (, Kj) (, Jkkllmm) (= nnn --- nnn) [LF] [NUL]</p> <p>② [ESC] XBaa; bbbb, cccc, d, e, ff, g, h (, Mi) (, Kj) (, Jkkllmm) (; oo₁, oo₂, oo₃ ----- oo₂₀) [LF] [NUL]</p>
Term	<p>aa: Bar code number 00 to 31</p> <p>bbbb: Print origin of X-coordinate of the bar code Fixed as 4 digits (in 0.1 mm units)</p> <p>cccc: Print origin of Y-coordinate of the bar code 4 or 5 digits (in 0.1 mm units)</p> <p>d: Type of bar code T: QR code (Two-dimensional code)</p> <p>e: Designation of error correction level L: High density level M: Standard level Q: Reliability level H: High reliability level</p> <p>ff: 1-cell width 00 to 52 (in dots)</p> <p>g: Selection of mode M: Manual mode A: Automatic mode</p> <p>h: Rotational angle of the bar code 0: 0° 1: 90° 2: 180° 3: 270°</p> <p>Mi: Selection of model (Omissible. If omitted, Model 1 is automatically selected.) i = 1: Model 1 2: Model 2</p> <p>Kj: Mask number (Omissible. If omitted, the number is automatically set.) j = 0 to 7: Mask number 0 to 7 8: No mask</p> <p>Jkkllmm: Connection setting (Omissible. No connection if this parameter is omitted.) kk = 01 to 16: Value indicating which divided code is connected. ll = 01 to 16: Number of divided codes mm = 00 to FF: A value for all data to be printed, to which XOR is applied in units of bytes (Not divided)</p> <p>nnn --- nnn: Data string to be printed (Omissible) Max. 2000 digits</p> <p>oo₁ --- oo₂₀: Link field No. (Omissible) 01 to 99 (1 to 99 can also be used.) Up to 20 digits can be designated using commas.</p>

⊙ In the case of MaxiCode Code (Two-dimensional code)

Format	
	① [ESC] XBaa; bbbb, cccc, d (, e) (, Jffgg) (, Zh) [LF] [NUL]
Term	
aa:	Bar code number 00 to 31
bbbb:	Print origin of X-coordinate of the bar code Fixed as 4 digits (in 0.1 mm units)
cccc:	Print origin of Y-coordinate of the bar code 4 or 5 digits (in 0.1 mm units)
d:	Type of bar code Z: MaxiCode (Two-dimensional code)
e:	Mode selection (Omissible) <ul style="list-style-type: none"> • When the MaxiCode specification setting is set to “TYPE1: Compatible with the current version” in the system mode. Omitted: Mode 2 0: Mode 2 1: Mode 4 2: Mode 2 3: Mode 3 4: Mode 4 5: Mode 2 6: Mode 6 7: Mode 2 8: Mode 2 9: Mode 2 • When the MaxiCode specification setting is set to “TYPE2: Special specification” in the system mode. Omitted: Mode 2 or Mode 3(*) 0: Mode 2 or Mode 3(*) 1: Mode 4 2: Mode 2 3: Mode 3 4: Mode 4 5: Mode 2 or Mode 3 (*) 6: Mode 6 7: Mode 2 or Mode 3 (*) 8: Mode 2 or MODE 3 (*) 9: Mode 2 or MODE 3 (*) <p style="margin-left: 40px;">*: Mode 2 or Mode 3 should be determined depending on the country code of the data command. When the country code is 840, Mode 2 should be selected. For other codes than 840, Mode 3 should be selected.</p>
Jffgg:	Connection setting (Omissible. No connection if this parameter is omitted.) ff: Code number 01 to 08 gg: No. of divided codes 01 to 08
Zh:	Attachment of Zipper block and Contrast block (Omissible. If omitted, they are not attached.) h= 0: No attachment of Zipper block and Contrast block 1: Attachment of Zipper block and Contrast block 2: Attachment of Zipper block 3: Attachment of Contrast block

⊙ In the case of CP code (Two-dimensional code)

Format	<p>① [ESC] XBaa; bbbb, cccc, d, e, ff, g, h (, Cijj) (= kkkk --- kkk) [LF] [NUL]</p> <p>② [ESC] XBaa; bbbb, cccc, d, e, ff, g, h (, Cijj) (; ll₁, ll₂, ll₃, --- ll₂₀) [LF] [NUL]</p>
Term	<p>aa: Bar code number 00 to 31</p> <p>bbbb: Print origin of X-coordinate of the bar code Fixed as 4 digits (in 0.1 mm units)</p> <p>cccc: Print origin of Y-coordinate of the bar code 4 or 5 digits (in 0.1 mm units)</p> <p>d: Type of bar code Y: CP code (Two-dimensional code)</p> <p>e: Designation of ECC (Error Correction Code) level 0: No designation 1: 10% 2: 20% 3: 30% 4: 40% 5: 50%</p> <p>Only when the number of code characters are specified, can "0" (No designation) be selected. If "0 (No designation)" is selected without specifying the number of code characters, the CP code is not printed. When the number of code characters are specified, blank code areas created after the characters are encoded should all be filled with ECC characters.</p> <p>ff: 1-cell width 00 to 99 (in dots)</p> <p>g: No. of character bits 0: Set automatically A: 8 bits</p> <p>Designates how many bits are used for representing a character. When "0" is designated, the optimal value is automatically set, according to data.</p> <p>h: Rotational angle of the bar code 0: 0° 1: 90° 2: 180° 3: 270°</p> <p>Cijj: No. of code characters (Set automatically when the designation is omitted.) ii = No. of characters in the X direction: 03 to 22 jj = No. of characters in the Y direction: 02 to 22 "Character" is a unit for code for encoding the CP code. 1 character occupies a 3×3 square block. When a value for "jj" larger than "ii" is set, an error occurs. The number of cells for the code is as follows. (No. of characters × 3 + 2)</p> <p>kkkk --- kkk: Data string to be printed (Omissible) Max. 473 digits</p> <p>ll₁, ll₂, ll₃, --- ll₂₀: Link field No. (Omissible) 01 to 99 (1 to 99 can also be used.) Up to 20 digits can be designated using commas.</p>

⊙ In the case of RFID (Data write)

Function	Writes a specified data onto an RFID tag. When the feed amount has been set by the RFID Tag Position Adjustment Command ([ESC] @003) for adjusting an RFID tag position, the specified amount of the media is fed forward or backward before writing data.
Format	<p>① [ESC]XBaa; bbbb, cccc, d (,Aeee) (,Mg) (,Ph) (,Fi) (,Tff) (,Djj) (,Gk) (,Cl) (,Smmmm) (,Ennnn) (,Rooooo) (,Kpppppp) (,Lqq) (,Jrrrrrr) (,Vs) (,Btt) (,uvvvvvvv) (=www-----www) [LF] [NUL]</p> <p>② [ESC]XBaa; bbbb, cccc, d (,Aeee) (,Mg) (,Ph) (,Fi) (,Tff) (,Djj) (,Gk) (,Cl) (,Smmmm) (,Ennnn) (,Rooooo) (,Kpppppp) (,Lqq) (,Jrrrrrr) (,Vs) (,Btt) (,uvvvvvvv) (;ww₁,ww₂,ww₃,-----,ww₂₀) [LF] [NUL]</p>
Term	<p>aa: Bar code number 00 to 31</p> <p>bbbb: Parameter not referred to Fixed to 4 digits (in 0.1 mm units)</p> <p>cccc: Parameter not referred to 4 or 5 digits (in 0.1 mm units)</p> <p>d: Type of bar code r: RFID (data write)</p> <p>Aeee: Address where the data is written (Omissible) 000 to 999 Designates the address where data starts to be written. When omitted, this parameter will be set to 18 for ISO18000-6B tag, or 0 for other tag types.</p> <p>Mg: Format of U-Code V1.19 (Omissible) 0: SGTIN 96 format 1: SSCC96 format 2: (Reserved) When the format of U-Code V1.19 is designated, the specified address, where the data is written, will become invalid. This parameter is effective only when the tag type is ISO18000-6B. When omitted, the U-Code V1.19 format is not used. When 2: (Reserved) is selected, operations are not guaranteed.</p> <p>Ph: Partition number (Omissible) 0 to 6 This parameter is effective only when U-Code V1.19 or EPC format is designated. When omitted, 5 will be set.</p> <p>Fi: Filter number (Omissible) 0 to 7 This parameter is effective only when U-Code V1.19 or EPC format is designated. When omitted, 0 will be set.</p> <p>Tff: Tag type (Omissible) 00: None 11: I-Code 12: Tag-it 13: C220 14: ISO15693 15: C210</p>

- 16: C240
- 17: C320
- 21: EPC Class 0
- 22: EPC Class 1
- 23: ISO 18000-6B
- 24: EPC Class 1 Generation 2

Designates the type of RFID tag onto which data is to be written.
 When omitted, the tag type set in the system mode will be designated.
 In accordance with the tag type designated by this setting, the tag type set in the system mode changes.
 When "00: NONE" is designated, the backed up tag type will be designated, and the system mode setting will not be changed.

- Dii: EPC format (Omissible)
- 00: No format (When omitted)
 - 10: GID-96
 - 11: SGTIN-64
 - 12: SGTIN-96
 - 13: SSCC-64
 - 14: SSCC-96
 - 15: SGLN-64
 - 16: SGLN-96
 - 17: GRAI-64
 - 18: GRAI-96
 - 19: GIAI-64
 - 20: GIAI-96
 - 21: DoD-64
 - 22: DoD-96

- Gk: Data type (Omissible)
- 0: No conversion of data (Default)
 - 1: Conversion to binary
 - 2: Conversion to hexadecimal

- Cl: On-the-fly issue (Omissible)
- 0: Disabled. (On-the-fly issue is not performed. (When omitted))
 - 1: Enabled. (On-the-fly issue is performed.)

- When "1: Enabled" is designated, writing data onto an RFID tag and printing are performed at the same time.
- The positions where RFID data write is started and ended during printing can be designated by the parameters of RFID data write start point designation for on-the-fly issue and RFID data write end point designation for on-the-fly issue, respectively.

Smmmm: RFID data write start point designation for on-the-fly issue (Omissible)
 4 or 5 digits (in 0.1 mm units) When omitted, 0 mm will be designated.

Ennnn: RFID data write end point designation for on-the-fly issue (Omissible)
 4 or 5 digits (in 0.1 mm units) When omitted, 75.5 mm (which is equals to the distance between the print head and the media sensor) will be designated.

Ro000000: Access password setting (Omissible)
 Fixed to 8-digit hexadecimal number
 00000000 to FFFFFFFF
 Sets a password to access tags.
 This parameter is effective only for EPC Class 1 Generation 2 tag type.

Kpppppppp: Kill password setting (Omissible)
 Fixed to 8-digit hexadecimal number
 00000000 to FFFFFFFF
 Sets a kill password for tags.
 This parameter is effective only for EPC Class 1 Generation 2 tag type.

Lqq: Lock/unlock setting (Omissible)

	Kill password	Access password	EPC code	TID	User data
00	Unlocked	Unlocked	Unlocked	Unlocked	Unlocked
01	Locked	Unlocked	Unlocked	Unlocked	Unlocked
02	Unlocked	Locked	Unlocked	Unlocked	Unlocked
03	Locked	Locked	Unlocked	Unlocked	Unlocked
04	Unlocked	Unlocked	Locked	Unlocked	Unlocked
05	Locked	Unlocked	Locked	Unlocked	Unlocked
06	Unlocked	Locked	Locked	Unlocked	Unlocked
07	Locked	Locked	Locked	Unlocked	Unlocked
08	Unlocked	Unlocked	Unlocked	Locked	Unlocked
09	Locked	Unlocked	Unlocked	Locked	Unlocked
10	Unlocked	Locked	Unlocked	Locked	Unlocked
11	Locked	Locked	Unlocked	Locked	Unlocked
12	Unlocked	Unlocked	Locked	Locked	Unlocked
13	Locked	Unlocked	Locked	Locked	Unlocked
14	Unlocked	Locked	Locked	Locked	Unlocked
15	Locked	Locked	Locked	Locked	Unlocked
16	Unlocked	Unlocked	Unlocked	Unlocked	Locked
17	Locked	Unlocked	Unlocked	Unlocked	Locked
18	Unlocked	Locked	Unlocked	Unlocked	Locked
19	Locked	Locked	Unlocked	Unlocked	Locked
20	Unlocked	Unlocked	Locked	Unlocked	Locked
21	Locked	Unlocked	Locked	Unlocked	Locked
22	Unlocked	Locked	Locked	Unlocked	Locked
23	Locked	Locked	Locked	Unlocked	Locked
24	Unlocked	Unlocked	Unlocked	Locked	Locked
25	Locked	Unlocked	Unlocked	Locked	Locked
26	Unlocked	Locked	Unlocked	Locked	Locked
27	Locked	Locked	Unlocked	Locked	Locked
28	Unlocked	Unlocked	Locked	Locked	Locked
29	Locked	Unlocked	Locked	Locked	Locked
30	Unlocked	Locked	Locked	Locked	Locked
31	Locked	Locked	Locked	Locked	Locked
32	Unlocked	Unlocked	Unlocked	Unlocked	Unlocked
33	Permanent lock	Unlocked	Unlocked	Unlocked	Unlocked
34	Unlocked	Permanent lock	Unlocked	Unlocked	Unlocked
35	Permanent lock	Permanent lock	Unlocked	Unlocked	Unlocked
36	Unlocked	Unlocked	Permanent lock	Unlocked	Unlocked
37	Permanent lock	Unlocked	Permanent lock	Unlocked	Unlocked
38	Unlocked	Permanent lock	Permanent lock	Unlocked	Unlocked
39	Permanent lock	Permanent lock	Permanent lock	Unlocked	Unlocked
40	Unlocked	Unlocked	Unlocked	Permanent lock	Unlocked
41	Permanent lock	Unlocked	Unlocked	Permanent lock	Unlocked
42	Unlocked	Permanent lock	Unlocked	Permanent lock	Unlocked
43	Permanent lock	Permanent lock	Unlocked	Permanent lock	Unlocked
44	Unlocked	Unlocked	Permanent lock	Permanent lock	Unlocked
45	Permanent lock	Unlocked	Permanent lock	Permanent lock	Unlocked
46	Unlocked	Permanent lock	Permanent lock	Permanent lock	Unlocked
47	Permanent lock	Permanent lock	Permanent lock	Permanent lock	Unlocked
48	Unlocked	Unlocked	Unlocked	Unlocked	Permanent lock
49	Permanent lock	Unlocked	Unlocked	Unlocked	Permanent lock
50	Unlocked	Permanent lock	Unlocked	Unlocked	Permanent lock
51	Permanent lock	Permanent lock	Unlocked	Unlocked	Permanent lock
52	Unlocked	Unlocked	Permanent lock	Unlocked	Permanent lock

53	Permanent lock	Unlocked	Permanent lock	Unlocked	Permanent lock
54	Unlocked	Permanent lock	Permanent lock	Unlocked	Permanent lock
55	Permanent lock	Permanent lock	Permanent lock	Unlocked	Permanent lock
56	Unlocked	Unlocked	Unlocked	Permanent lock	Permanent lock
57	Permanent lock	Unlocked	Unlocked	Permanent lock	Permanent lock
58	Unlocked	Permanent lock	Unlocked	Permanent lock	Permanent lock
59	Permanent lock	Permanent lock	Unlocked	Permanent lock	Permanent lock
60	Unlocked	Unlocked	Permanent lock	Permanent lock	Permanent lock
61	Permanent lock	Unlocked	Permanent lock	Permanent lock	Permanent lock
62	Unlocked	Permanent lock	Permanent lock	Permanent lock	Permanent lock
63	Permanent lock	Permanent lock	Permanent lock	Permanent lock	Permanent lock

Designates the areas to be locked. When omitted, no areas are locked.

This parameter is effective only for EPC Class 1 Generation 2 tag type.

Jrrrrrrr: Access to the password-protected tags (Omissible)

Fixed to 8-digit hexadecimal number

00000000 to FFFFFFFF

Accesses the password-protected tags.

This parameter is effective only for EPC Class1 Generation 2 tag type.

Vs: Write data verify designation (Omissible)

0: Verification disabled (Omissible)

1: Verification enabled

This parameter verifies if data has been written successfully. Select "1" (Verification enabled) for tags which may generate a phenomenon that the written data may not be the same as actual data even when an issue has successfully completed. When "1" is selected, it takes more time than when "0" (Verification disabled) is selected.

Btt: Designates the area where the data is written (Omissible)

00: Blank0 (Reserved area)

01: Blank1 (EPC area) (When omitted)

02: Blank2 (TID area)

03: Blank3 (User area)

This parameter is effective only for EPC Class1 Generation 2 tag type.

When a format is designated, this parameter is ignored.

uvvvvvvvvv: Increment/Decrement

(Omissible. When omitted, incrementing/decrementing is not performed.)

u: Indicates whether to increment or decrement

+: Increment

-: Decrement

vvvvvvvvvv: Skip value (10 digits)

0000000000 to 9999999999

www---www: Print data string (Omissible)

Max. 512 digits, but the number of digits to be written is different depending on the tag types.

ww₁,ww₂,ww₃,----,ww₂₀: Link field No. (Omissible)

01 to 99 (1 to 99 can also be used.)

Up to 20 fields can be designated using commas.

⊙ In the case of RFID (Data read)

Function	Reads an RFID tag which is positioned above the antenna. When the feed amount has been set by the RFID Tag Position Adjustment Command ([ESC] @003) for adjusting an RFID tag position, the specified amount of the media is fed forward or backward before reading the RFID data. The read RFID data is transmitted included in an RFID read terminate status after printing is completed.
Format	① [ESC] XBaa; bbbb, cccc, d, (, Neee) (, Afff) (, lh) (, Jiiiiiii) [LF] [NUL]
Term	<p>aa: Bar code number 00 to 31</p> <p>bbbb: Parameter not referred to Fixed to 4 digits (in 0.1 mm units)</p> <p>cccc: Parameter not referred to 4 or 5 digits (in 0.1 mm units)</p> <p>d: Type of bar code r: RFID (data read)</p> <p>Neee: Number of bytes to be read (Omissible) 0001 to 4096 When omitted, the number of bytes specified for the tag type being used will be designated.</p> <p>Afff: Address where the data is read (Omissible) 000 to 999 Designates the address where data starts to be read. When omitted, this parameter will be set to 18 for ISO18000-6B tag, or 0 for other tag types.</p> <p>Tgg: Tag type (Omissible) 00: None 11: I-Code 12: Tag-it 13: C220 14: ISO15693 15: C210 16: C240 17: C320 21: EPC Class 0 22: EPC Class 1 23: ISO 18000-6B 24: EPC Class 1 Generation 2 Designates the type of RFID tag from which data is to be read. When omitted, the tag type set in the system mode will be designated. In accordance with the tag type designated by this setting, the tag type set in the system mode changes. When "00: NONE" is designated, the backed up tag type will be designated, and the system mode setting will not be changed.</p>

- Ih: RFID read mode (Omissible)
1: Only user data is read.
2: Only tag ID is read.
3: Both tag ID and user data are read.
When omitted, only user data will be read.
- Jiiiiiii: Access to the password-protected tags (Omissible)
Fixed to 8-digit hexadecimal number
00000000 to FFFFFFFF
Accesses the password-protected tags.
This parameter is effective only for EPC Class 1 Generation 2 tag type.

Explanation

- (1) The parameter, "Number of bytes to be read", is effective only when RFID read mode is set to 1 or 3, as this parameter is intended for reading user data. When reading tag ID, this parameter is ignored.
- (2) When the value exceeding the maximum number of bytes storable in a tag is designated for "Number of bytes to be read", a read error results.
- (3) With RFID (data read) being specified by this command, when an RFID data read failed, the printer will retry to read data after sending a void pattern printing end status (60H) or result in an error and stop after sending an RFID write error status (61H).

SOH	01H	Indicates the start of the status block
STX	02H	
Status	34H	Printer status
	32H	
Status type	34H	Indicates the end of an RFID read and issue.
Remaining count	3XH	Remaining issue count
	3XH	
	3XH	
	3XH	
Tag type	XXH	30H30H: RFID read failed. 31H31H: I-Code 31H32H: Tag-it 31H33H: C220 31H34H: ISO15693 31H35H: C210 31H36H: C240 31H37H: C320
	XXH	32H31H: EPC Class 0 32H32H: EPC Class 1 32H33H: ISO18000-6B 32H34H: EPC Class 1 Generation 2
Length	XXH	RFID data length
	XXH	
RFID data	XXH	Tag ID + User data * Data to be read is different depending on the RFID read mode setting.
	XXH	
	⋮	
	⋮	
	XXH	
ETX	03H	Indicates the end of the status block.
EOT	04H	
CR	0DH	
LF	0AH	

- (4) When an access password is designated using this command, writing data onto a tag cannot be performed if an access password registered in the tag differs from the access password designated. However, reading data can be performed.

Explanation

(1) Bar code number

When drawing by the Data Command ([ESC] RB), the format designated by the bar code number is selected.

(2) Print origin of coordinates

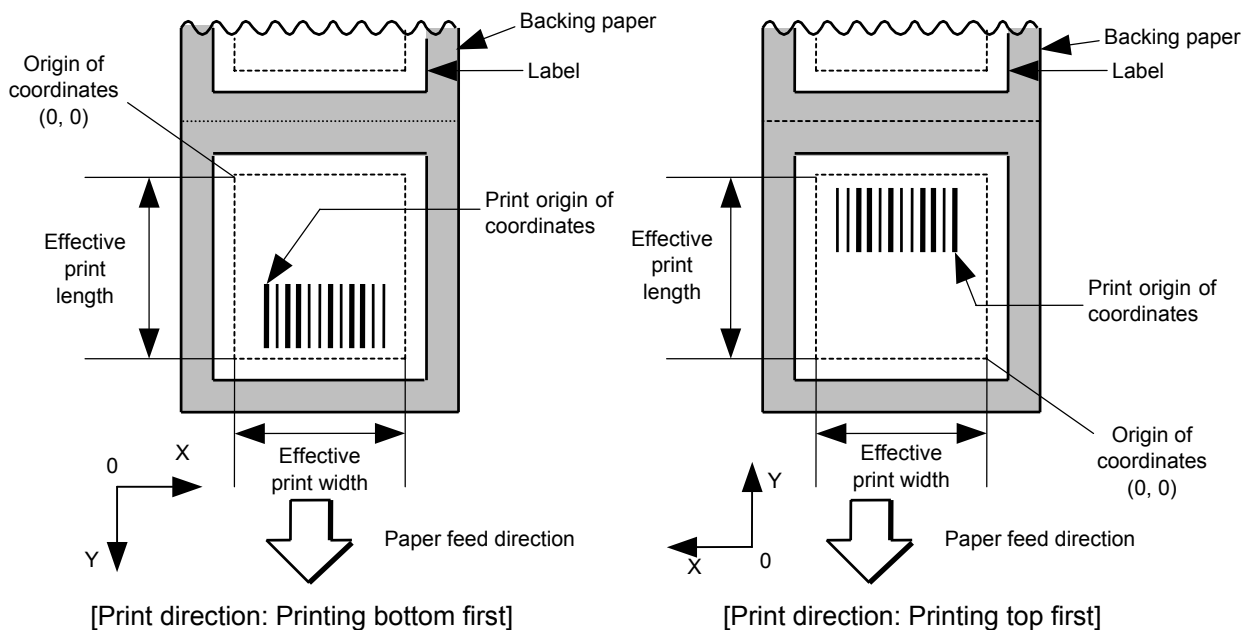

The print origin of coordinates must be set so that the bar code drawing result will be within the effective print area set by the Label Size Set Command ([ESC] D).

[Effective print area]

[mm]

Model		B-SX4T					B-SX5T					
		Batch	Strip	Swing cutter	Cut		Batch	Strip	Swing cutter	Cut		
					Head-up operation not performed	Head-up operation performed				Head-up operation not performed	Head-up operation performed	
Item	Issue mode											
Effective print width	Min.	10.0					10.0					
	Max.	104.0					128.0					
Effective print length	Label	Min.	6.0	21.4	23.0	3 ips: 79.0	3 ips: 30.0	6.0	21.4	23.0	3 ips: 79.0	3 ips: 30.0
						6 ips: 91.0	6 ips: 30.0				5 ips: 87.0	5 ips: 30.0
						10 ips: – (NOTE 1)	10 ips: – (NOTE 1)				8 ips: 98.0	8 ips: 30.0
	Tag	Min.	8.0	–	23.4	3 ips: 28.0		8.0	–	23.4	3 ips: 28.0	
						6 ips: 28.0					5 ips: 28.0	
						10 ips: – (NOTE 1)					8 ips: 36.0	
	Max.	1496.0	–	1492.0	1492.0		1496.0	–	1492.0	1492.0		
	Max.	1498.0	–	1498.0	1498.0		1498.0	–	1498.0	1498.0		

NOTE 1: The use of the rotary cutter at 10 ips is not supported for the B-SX4T.

(3) Type of bar code

0: JAN8, EAN8



1: MSI



2: Interleaved 2 of 5



3: CODE39 (standard)



4: NW7



5: JAN13, EAN13



6: UPC-E



7: EAN13 + 2 digits



8: EAN13 + 5 digits



9: A: CODE128



B: CODE39 (Full ASCII)



C: CODE93

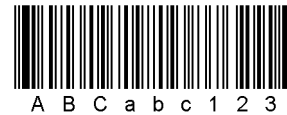

G: UPC-E + 2 digits



H: UPC-E + 5 digits



I: EAN8 + 2 digits



J: EAN8 + 5 digits



K: UPC-A



L: UPC-A + 2 digits



M: UPC-A + 5 digits



N: UCC/EAN128



O: Industrial 2 of 5



P: PDF417



Q: Data Matrix



R: Customer bar code



S: Highest priority customer bar code



T: QR code



U: POSTNET



V: RM4SCC



W: KIX code



X: MicroPDF417



Y: CP Code



Z: MaxiCode

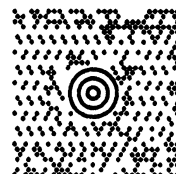

b: RSS family

RSS-14



RSS-14 Stacked



RSS-14 Stacked Omnidirectional



RSS-14 Limited



RSS Expanded



(4) Type of check digit

- ① Where no check digit is attached, the bar code of the data row will be drawn.
- ② In the case of the check digit check, if each check digit checked according to the type of bar code is normal, the bar code will be drawn. If the check digit not meeting the requirement is designated, the bar code will not be drawn.
- ③ In the case of the check digit auto attachment, each check digit is attached according to the type of bar code and the bar code is drawn.
- ④ If the type of bar code is CODE93, CODE128 (with auto code selection), or UCC/EAN128, the check digit will always be attached regardless of the designation of the type of check digit.
- ⑤ If the type of bar code is JAN, EAN, or UPC, the designation of no check digit attachment automatically assumes the check digit check.
- ⑥ DBP Modulus 10 is Modulus 10 for Deutsche Bundespost Postdienst only.

(5) Bar width, space width, and character-to-character space

Designate the bar, space, and character-to-character space widths according to the type of bar code. Note that the designated proper value differs according to the rotational angle of bar code, type, number of digits, print speed, paper used, etc. Examples of such designations are listed below. (1 dot = 1/12 mm)

In the case of JAN, EAN, UPC, CODE93, CODE128, UCC/EAN128, PDF417, or MicroPDF417, a 2 to 6-module width is automatically calculated when a 1-module width is designated.

[Example of setting]

B-SX4T:

Type of bar code	1 module		2 modules		3 modules		4 modules		5 modules		6 modules	
	Bar	Space	Bar	Space	Bar	Space	Bar	Space	Bar	Space	Bar	Space
JAN, EAN, UPC	3		6		9		12		-		-	
CODE93	2		4		6		8		-		-	
CODE128, EAN128	2		4		6		8		-		-	
PDF417	2		4		6		8		10		12	
MicroPDF417	2		4		6		8		10		12	

Type of bar code	Narrow		Wide		Character-to-character space
	Bar	Space	Bar	Space	
MSI	2	2	6	6	0
ITF	2	2	6	6	0
CODE39	2	2	6	6	2
NW7	2	2	6	6	2
Industrial 2 of 5	2	2	6	0	2
MATRIX 2 of 5	2	2	6	6	2

B-SX5T:

Type of bar code	1 module		2 modules		3 modules		4 modules		5 modules		6 modules	
	Bar	Space	Bar	Space	Bar	Space	Bar	Space	Bar	Space	Bar	Space
JAN, EAN, UPC	4		8		12		16		-		-	
CODE93	3		6		9		12		-		-	
CODE128, EAN128	3		6		9		12		-		-	
PDF417	3		6		9		12		15		18	
MicroPDF417	2		4		6		8		10		12	

Type of bar code	Narrow		Wide		Character-to-character space
	Bar	Space	Bar	Space	
MSI	3	3	8	8	0
ITF	3	3	8	8	0
CODE39	3	3	8	8	3
NW7	3	3	8	8	3
Industrial 2 of 5	3	3	8	0	3
MATRIX 2 of 5	3	3	8	8	3

When NW7 is used, transmission of the space character assumes the space of (narrow space ×12) dots. In this case, the space is max. 255 dots.

In the case of Data Matrix or CP code

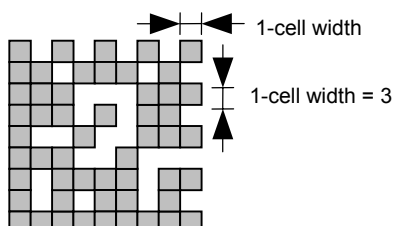

When 1-cell width is 00 for the Data Matrix or CP code, a two-dimensional code is not drawn. However, the two-dimensional code printed on the previous label is cleared.

In the case of QR code

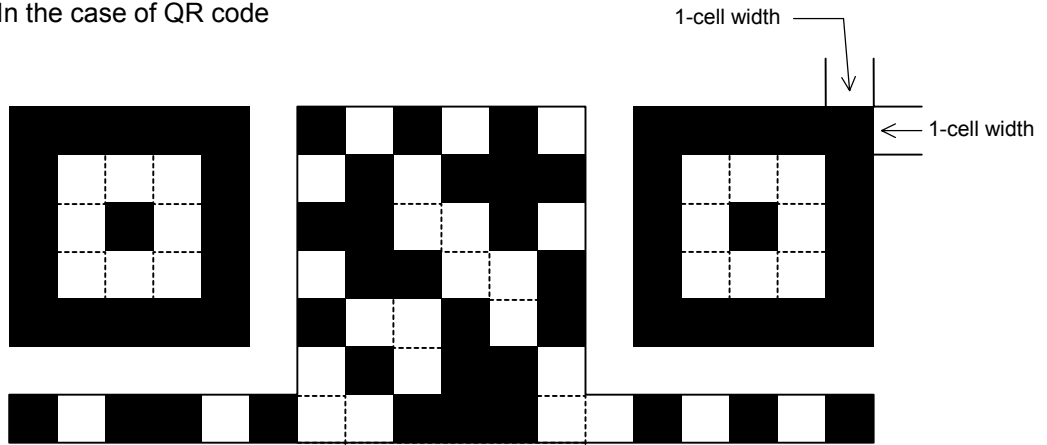

When the 1-cell width is 0, a two-dimensional code is not drawn. However, the bar code printed on the previous label is cleared.

In the case of a postal code

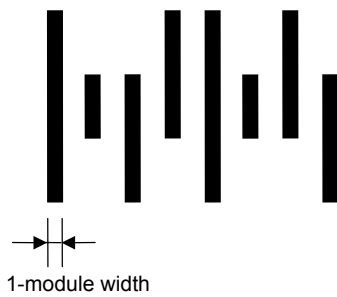

(6) Rotational angle of bar code

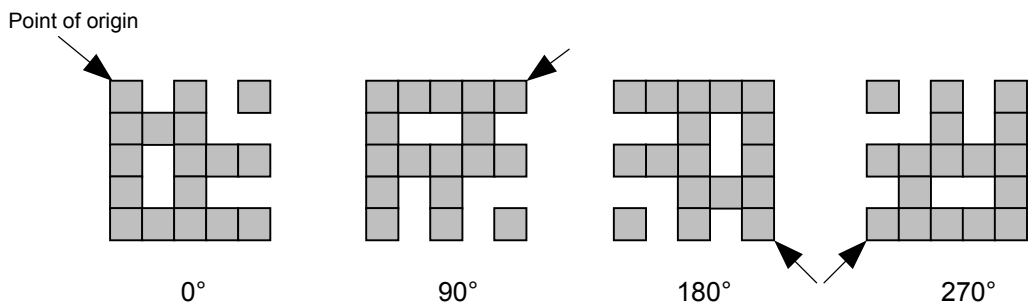
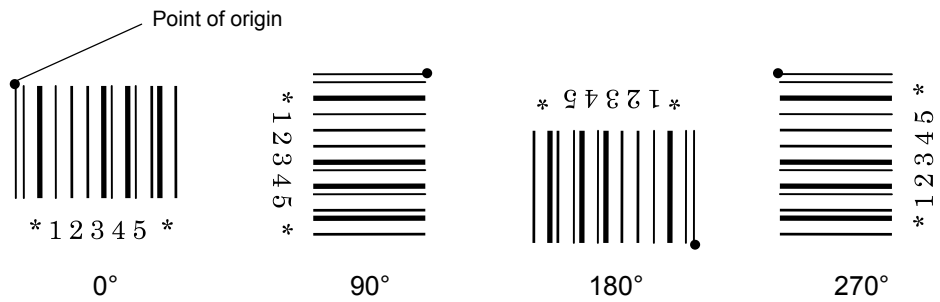

(7) Bar code height

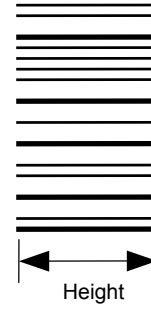

[PDF417, MicroPDF417]



[Postal code]

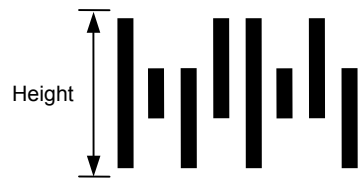

[RSS-14]



[RSS-14 Stacked]

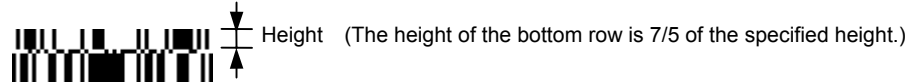

[RSS-14 Stacked Omnidirectional]

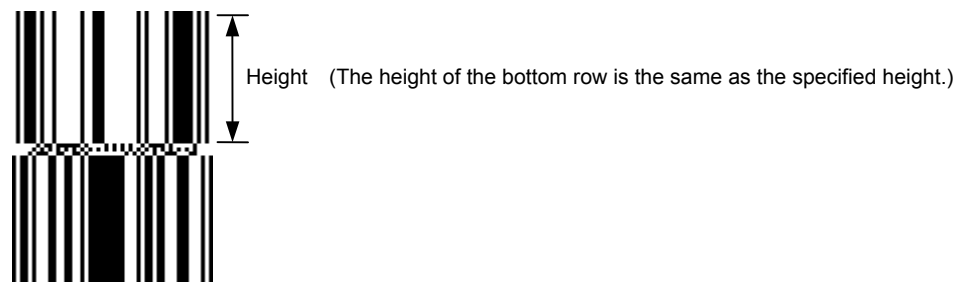

[RSS-14 Limited]



[RSS-14 Expanded]



When the bar code height is 0000, bar code (including guard bars) and numerals under bars are not drawn. However, the bar code printed on the previous label is cleared.

(8) Length of guard bar

The length of guard bar is valid only when the type of bar code is WPC. It is ignored in all other cases.

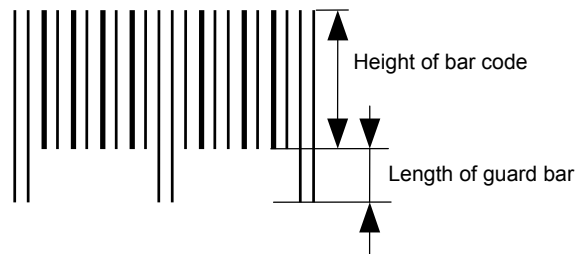

(9) Numerals under bars

Numerals are/are not provided under bars according to the parameter for print/non print of numerals under bars. The contents of numerals under bars to be printed vary according to the type of bar code. The character set of numerals under bars is OCR-B. Such numerals are enlarged or reduced only horizontally according to the width of the bar code. They are drawn vertically in the fixed one magnification.

[Drawing positions of numerals under bars]

① In the case of JAN and EAN

(Example) EAN13 + 2 digits



(Example) EAN8



- ② In the case of UPC
 (Example) UPC-A + 2 digits



- (Example) UPC-E



- ③ In the case of bar codes other than JAN, EAN, and UPC
 (Example) CODE39

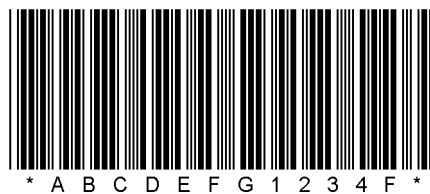

- (Example) UCC/EAN128

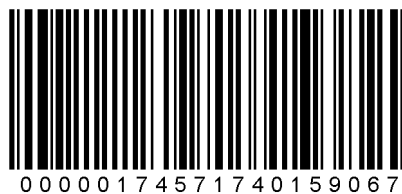

(10) Start/Stop Code

- This parameter is valid only when the type of bar code is CODE39 and NW7.
- Where the parameter is designated, the program will not check if the stop code and the start code are attached to the print data to be sent.
- When the parameter is omitted in the case of CODE39 and NW7, a start/stop code will be attached. The code to be added is “*” in the case of CODE39, and “a” in the case of NW7.
- For details, refer to chapter 15 “AUTOMATIC ADDING OF START/STOP CODES”.

(11) Increment/decrement

Printing is performed while the data is incremented or decremented every time a label is issued. Where the data row exceeds the maximum number of digits (40), the data row will not be drawn.

When CODE128 (without auto code selection) is used, the number of the start code (code A, code B, and code C) digits is regarded as 2.

Initial value	0000	0000	0000	0000	999999
INC/DEC	+10	+10	+10	+10	+1
Zero suppression	Not designated	5	3	0	3
1st label	0000	0000	└000	0000	999999
2nd label	0010	0010	└010	0010	└└└000
3rd label	0020	0020	└020	0020	└└└001
4th label	0030	0030	└030	0030	└└└002
5th label	0040	0040	└040	0040	└└└003

Letters and numerals for increment/decrement

For CODE39 (standard), CODE39 (full ASCII), NW-7, CODE93, CODE128, if a data string other than numerals are included in the data, increment/decrement is performed. If any code which does not exist in each bar code table is contained in the data, increment/decrement is not performed.

Up to 40 digits (including letters, numerals, and symbols) are possible. Only the numerals are selected and calculated for incrementing/decrementing, and then are returned to the previous position to draw the data.

Example of increment/decrement calculation

Initial value	00000	A0A0A	7A8/9	A2A0A
INC/DEC	+1	+1	+3	-3
1st label	00000	A0A0A	7A8/9	A2A0A
2nd label	00001	A0A1A	7A9/2	A1A7A
3rd label	00002	A0A2A	7A9/5	A1A4A
4th label	00003	A0A3A	7A9/8	A1A1A
5th label	00004	A0A4A	8A0/1	A0A8A

Example of increment/decrement of data including the special codes of CODE128

Increment/decrement calculation starts from the last digit in the data strings. When the data string to be calculated is numeric, and the next (upper) digit is ">", the data is a special code (shown with underline below). The next digit is calculated without incrementing/decrementing these two digits.

Example of increment/decrement calculation of CODE128

Initial value	00000	00>08	0A>08	0A9>08
INC/DEC	+1	+1	+1	+1
1st label	00000	00>08	0A>08	0A9>08
2nd label	00001	00>09	0A>09	0A9>09
3rd label	00002	01>00	1A>00	1A0>00
4th label	00003	01>01	1A>01	1A0>01
5th label	00004	01>02	1A>02	1A0>02

(12) Zero suppression

No. of zeros to be suppressed	0	1	2	2	3	4	5
Data	0000	0000	0000	0A12	0123	0123	0123
Print	0000	▯▯▯0	▯▯00	▯A12	▯123	0123	0123

The leading zero(s) in a data row is replaced by a space(s) according to the designated number of digits. However, if the number of digits to be suppressed is greater than the data row, the data row will be drawn without zero suppression. Where the data row exceeds the maximum number of digits (40), the data row will not be drawn.

When the print data including start/stop codes are sent to sending print data, the start/stop codes are also counted as a digit each. When the bar code type is JAN, EAN, UPC, or UCC/EAN 128, the data will be drawn without zero suppression.

(13) Data string to be printed

Drawing data can be programmed by designating the number of digits after the symbol “=”.” The maximum number of digits to be printed varies according to the types of bar codes. For codes, refer chapter 13 “BAR CODE TABLE”.

(14) Link field No.

The link field No. can be programmed by designating it after the symbol “;.” After the link field No. is designated using the Format Command, the data string are linked by the Link Field Data Command to draw an image.

Up to 20 fields can be linked.

The following shows an example of linked fields on the two continuous labels.

[Format Command]

- [ESC] PC01;..... ; 01 [LF] [NUL] : Link field No. 1 is designated.
- [ESC] PC02;..... ; 03 [LF] [NUL] : Link field No. 3 is designated.
- [ESC] PC03;..... ; 04 [LF] [NUL] : Link field No. 4 is designated.
- [ESC] XB01;..... ; 03, 04 [LF] [NUL] : Link fields No. 3 and No. 4 are designated.

- [ESC] PC04;..... ; 02 [LF] [NUL] : Link field No. 2 is designated.
- [ESC] PC05;..... ; 03 [LF] [NUL] : Link field No. 3 is designated.
- [ESC] PC06;..... ; 04 [LF] [NUL] : Link field No. 4 is designated.
- [ESC] XB02;..... ; 03, 04 [LF] [NUL] : Link fields No. 3 and No. 4 are designated.

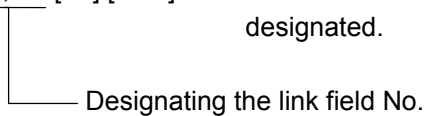

[Data Command]
 [ESC] RB; A [LF] B [LF] ABCD [LF] 001 [LF] [NUL]

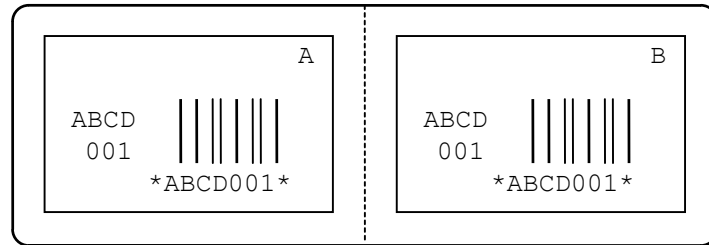

(15) Explanation for Data Matrix

① ECC type

Data Matrix contains a function to correct a code reading error using an error correction code (ECC) and restore normal data. Since there are several ECCs. ECC should be designated according to usage. The general correction ability is as follows. However, it may vary according to the error conditions.

ECC type	Error Correction Ability	Overhead by ECC
ECC0	<div style="text-align: center;"> <div style="border: 1px solid black; padding: 2px; display: inline-block;">Low</div> ↑ ↓ <div style="border: 1px solid black; padding: 2px; display: inline-block;">High</div> </div>	0%
ECC50		25%
ECC80		33%
ECC100		50%
ECC140		75%
ECC200		Approx. 30%

② Format ID

Data Matrix can handle all codes including alphanumerics, symbols and Kanji. Since data compression rate varies according to codes, a code to be used is designated using the format ID.

Format ID	Code	Details
1	Numerics	0 to 9 space
2	Letters	A to Z space
3	Alphanumerics, symbols	0 to 9 A to Z space . , - /
4	Alphanumerics	0 to 9 A to Z space
5	ASCII (7 bit)	00H to 7FH
6	ISO (8 bit)	00H to FFH (Kanji)

③ Maximum number of digits

The maximum number of digits varies according to the ECC type or format ID. Since each Kanji character uses 2 bytes, the maximum number of digits for it becomes half of the following values.

	ECC0	ECC50	ECC80	ECC100	ECC140
Format ID 1	500	457	402	300	144
Format ID 2	452	333	293	218	105
Format ID 3	394	291	256	190	91
Format ID 4	413	305	268	200	96
Format ID 5	310	228	201	150	72
Format ID 6	271	200	176	131	63

	Numeric	Alphanumeric	8 bit
ECC200	2000	2000	1556

For the maximum number of digits in cell units, see the next page.

④ Connection setting

The connection setting is used to comprise data with a set of two-dimensional codes when the data cannot be expressed with a two-dimensional code. When three two-dimensional codes are used to comprise data, identification information of 1/3, 2/3, and 3/3 is inserted into each two-dimensional code. The ID number is programmed to include a proper combination of two-dimensional codes when one label contains plural connecting symbols. For example, when there are two kinds of data containing identification information for 1/2 and 2/2 in the same label, combination of two-dimensional codes is unclear. By adding the ID number, the combination is made clearer.

Cell size and the effective data capacity

Symbol size		ECC000			ECC050			ECC080			ECC100			ECC140		
		Numeric capacity	Alphanum capacity	8-bit byte capacity	Numeric capacity	Alphanum capacity	8-bit byte capacity	Numeric capacity	Alphanum capacity	8-bit byte capacity	Numeric capacity	Alphanum capacity	8-bit byte capacity	Numeric capacity	Alphanum capacity	8-bit byte capacity
Row	Col															
9	9	3	2	1	–	–	–	–	–	–	–	–	–	–	–	–
11	11	12	8	5	1	1	–	–	–	–	–	–	–	–	–	–
13	13	24	16	10	10	6	4	4	3	2	1	1	–	–	–	–
15	15	37	25	16	20	13	9	13	9	6	8	5	3	–	–	–
17	17	53	35	23	32	21	14	24	16	10	16	11	7	2	1	1
19	19	72	48	31	46	30	20	36	24	16	25	17	11	6	4	3
21	21	92	61	40	61	41	27	50	33	22	36	24	15	12	8	5
23	23	115	76	50	78	52	34	65	43	28	47	31	20	17	11	7
25	25	140	93	61	97	65	42	82	54	36	60	40	26	24	16	10
27	27	168	112	73	118	78	51	100	67	44	73	49	32	30	20	13
29	29	197	131	86	140	93	61	120	80	52	88	59	38	38	25	16
31	31	229	153	100	164	109	72	141	94	62	104	69	45	46	30	20
33	33	264	176	115	190	126	83	164	109	72	121	81	53	54	36	24
35	35	300	200	131	217	145	95	188	125	82	140	93	61	64	42	28
37	37	339	226	148	246	164	108	214	143	94	159	106	69	73	49	32
39	39	380	253	166	277	185	121	242	161	106	180	120	78	84	56	36
41	41	424	282	185	310	206	135	270	180	118	201	134	88	94	63	41
43	43	469	313	205	344	229	150	301	201	132	224	149	98	106	70	46
45	45	500	345	226	380	253	166	333	222	146	248	165	108	118	78	51
47	47	500	378	248	418	278	183	366	244	160	273	182	119	130	87	57
49	49	500	413	271	457	305	200	402	268	176	300	200	131	144	96	63

Symbol size		ECC200		
		Numeric capacity	Alphanum capacity	8-bit byte capacity
Row	Col			
10	10	6	3	1
12	12	10	6	3
14	14	16	10	6
16	16	24	16	10
18	18	36	25	16
20	20	44	31	20
22	22	60	43	28
24	24	72	52	34
26	26	88	64	42
32	32	124	91	60
36	36	172	127	84
40	40	228	169	112
44	44	288	214	142
48	48	348	259	172
52	52	408	304	202
64	64	560	418	278
72	72	736	550	366
80	80	912	682	454
88	88	1152	862	574
96	96	1392	1042	694
104	104	1632	1222	814
120	120	2000	1573	1048
132	132	2000	1954	1302
144	144	2000	2000	1556

Rectangular code

Symbol size		ECC200		
		Numeric capacity	Alphanum capacity	8-bit byte capacity
Row	Col			
8	18	10	6	3
8	32	20	13	8
12	26	32	22	14
12	36	44	31	20
16	36	64	46	30
16	48	98	72	47

(16) Explanation for the PDF417 and MicroPDF417

① Security level

The PDF417 contains a function to correct a code reading error using an error correcting code word and restore normal data. The security level should be designated according to usage to perform the error correction function.

For the MicroPDF417, the printer sets the security level automatically.

Security level	Error Correction Ability	No. of error correction code words
Level 0	<div style="display: flex; flex-direction: column; align-items: center;"> <div style="border: 1px solid black; padding: 2px 10px;">Low</div> <div style="margin: 5px 0;">↑</div> <div style="margin: 5px 0;">↓</div> <div style="border: 1px solid black; padding: 2px 10px;">High</div> </div>	0
Level 1		2
Level 2		6
Level 3		14
Level 4		30
Level 5		62
Level 6		126
Level 7		254
Level 8		510

② No. of columns (strings)

The number of rows are variable in the PDF417. The row length (No. of data strings) is also variable. Therefore, a symbol can be created in a form that can be easily printed, by changing the proportion of the height and width.

The number of columns (data strings) is varied between 1 and 30.

If the number of columns is too small when the data amount is large and the security level is high, drawing may not be performed. This is because the number of rows exceeds 90 when the number of columns becomes small. (When the PDF417 is used, the number of rows of symbols is limited from 3 to 90.)

For the MicroPDF417, not only the number of columns (data strings) but also the number of rows (data lines) can be designated. When these are to be designated, see the table on page 100. Note that the max. number of digits for the set parameter (gg) varies according to the character type. If data over the max. number of digits for the set parameter (gg) is set, the bar code is not printed. The number of columns (data strings) is varied from 1 to 4.

However, the max. number of lines, which is 44, depends on the number of columns.

(17) Explanation for QR code

① Error correction level

The QR code contains functions to detect and correct an error. If one of the data characters is damaged, the information can be restored when this code is read.

There are 4 levels that can be designated. The level should be specified according to usage. The general correction ability is as follows.

Level	Error correction ability	Overhead by correcting an error
High density level	<div style="display: flex; flex-direction: column; align-items: center;"> <div style="margin-bottom: 5px;">Low</div> <div style="margin: 5px 0;">↑</div> <div style="margin: 5px 0;">↓</div> <div style="margin-top: 5px;">High</div> </div>	7%
Standard level		15%
Reliability level		25%
High reliability level		30%

② 1-cell width

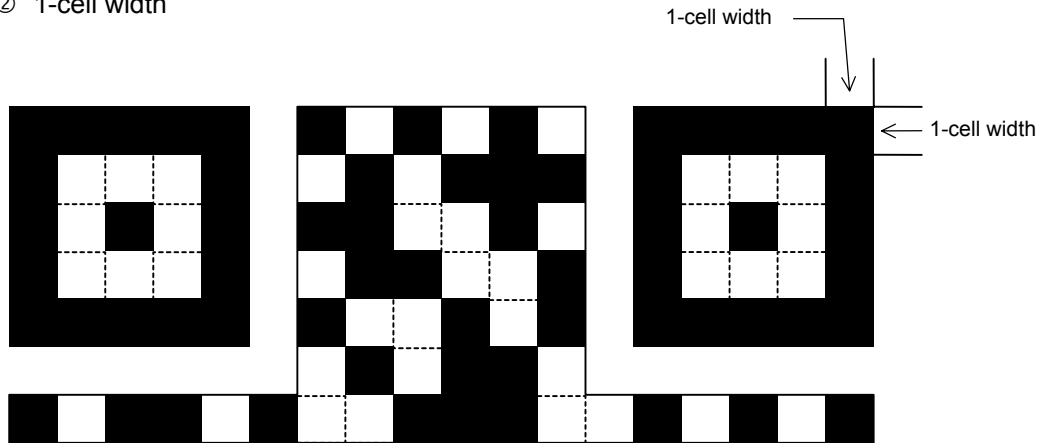

When the 1-cell width is 0, a two-dimensional code is not drawn. However, the two-dimensional code printed on the previous label is cleared.

③ Selection of mode

All codes including alphanumerics, symbols, and Kanji can be used in one QR code. Manual mode or automatic mode can be selected to perform the operation.

④ Selection of model

Model 1: Original specification

Model 2: Extended specification which enhances the function of position correction and can contain a large amount of data.

⑤ Mask number

To be sure the QR code is read, it is preferable that white and black modules are arranged in this symbol in a balanced manner. This prevents the bit pattern “1011101”, which is characteristically seen in the position detecting pattern, from appearing in the symbol as much as possible.

The mask number is 0 to 7. The pattern is determined by placing each masking pattern for the mask number upon the module pattern. When the mask number is set to 8, masking is not performed. When the parameter is omitted, the most appropriate mask number is automatically selected to perform masking.

⑥ Connection setting

For QR code, data can be divided into several codes. Even though there is only a narrow print space, the code can be entered in the space by dividing the code. The data can be divided into a max. of 16 codes. Parity data is obtained by XORing all input data in units of bytes before dividing. The input data is calculated based on shift JIS for Kanji, or on JIS 8 for others. Examples are shown below:

“0123456789日本 ” is divided into “0123”, “4567”, and “89日本 ”.

Code No. 1	No. of divided codes: 3	Parity data: 84	Data “0123”
Code No. 2	No. of divided codes: 3	Parity data: 84	Data “4567”
Code No. 3	No. of divided codes: 3	Parity data: 84	Data “89日本 ”

* The parity data is the XORed value for “0123456789日本 ”.

30 31 32 33 34 35 36 37 38 39 93 FA 96 7B = 85

(18) Explanation for MaxiCode

① Connection setting

For MaxiCode, data can be divided into a max. of 8 codes.

(19) Explanation for CP code

① ECC (Error Correction Code) level

The CP code contains a function to correct a code reading error using an error correcting code word and restore normal data. The error correction level should be selected according to usage to perform the error correction function.

The higher the percentage of the error correcting code word is, the higher the error correcting ability is.

For the CP code, the program is designed so that all remaining areas are used for correcting errors when the number of code characters is specified by a user. When the number of code characters is specified, "0" (No designation) can be used.

When the number of code characters is not specified by the user, a value from 10 to 50% must be selected. The printer automatically determines the number of code characters so that the error correcting code word exceeds the percentage specified by the user.

② The number of bits per character

Data is compressed by using the 8-bit compression method. If "0" is specified, the data is compressed in the same way.

Character set for 8 bits

8 bits: ISO 00H to FFH (for Kanji)

③ The number of code characters

For the CP code, a 3×3 cell is used for one block, and the block set forms the CP code.

The numbers of characters in the X and Y directions can be set by the user.

If "0" is specified, the printer automatically sets the smallest code size in which data set by the user can be contained.

The rectangular code can be specified. The value for the Y direction must be smaller than the X direction.

The number of cells for the code is as follows.

(No. of code characters) × 3 + 2

(20) Explanation for RFID

① The number of bytes to be written

.The number of bytes to be written on the tag depends on the type of tag.

② Sequence of writing data on the RFID tag

Data is written on the RFID tag prior to printing. When +3-mm or more feed, or a -3-mm or less feed has been set in the @003 command, the printer performs a forward/reverse feed before printing, according to the command setting.

When writing data onto the RFID tag succeeds, the printer feeds the paper in the direction opposite to the feed performed before data write, and then starts printing.

If writing data fails, and when the parameter of RFID adjustment for retry has been set to +3mm or more, or -3mm or less in the system mode, the printer performs a forward/reverse feed again and retries to write data.

If writing data failed again, the printer prints the void pattern on that paper to abandon it, and retries the next tag up to the max. number of RFID issue retries.

③ Writing binary data on RFID tags

When writing binary data on RFID tags, the data is specified by attaching a '>'. Or, the data is converted to binary format when "conversion to binary" is designated for the data type, and converted to hexadecimal format when "conversion to hexadecimal" is designated for the data type. In the case of binary format, only '0' and '1' are used. In the case of hexadecimal format, '0' to 'F' are used.

(Example) To specify "00H01H02H"

No conversion:	>@>A>B
Conversion to binary:	0000000000000000100000010
Conversion to hexadecimal:	000102

For details, refer to Chapter 13 BAR CODE TABLE.

④ On-the-fly issue

When "On-the-fly issue" is enabled for RFID write, a data write time depends on the start point, the end point, and the print speed. If that time is shorter than the time required to write data onto an RFID tag (300 msec.), the printer will not perform the on-the-fly issue. When a write error occurs during the on-the-fly issue, the printer will feed the paper backward and print the void pattern on it. When the printer has no ribbon saving module, the RFID tag paper may be jammed at the print head during a reverse feed. Even if the printer includes a ribbon saving module, care must be taken not to cause a paper jam during strip issue.

Success rate of data write onto RFID tags is high when the print speed is as slow as 3 inches/sec. Even if the on-the-fly issue is enabled, it may take much time to issue RFID tag paper because the printer will feed the paper backward when an error occurs. Therefore, the total throughput could be higher when the print condition is set so that the on-the-fly issue is not performed, RFID data is written prior to printing and print speed is 10 inches/sec.

⑤ U-Code V1.19 and EPC format

When U-Code V1.19 or EPC format is designated, data will be written onto an RFID tag in the format of its own.

Data is all specified with numbers, and no partitions are inserted between the fields.

When U-Code V1.19 and EPC format are designated and both designations are incorrect, U-Code V1.19 takes precedence over the EPC format.

When U-Code V1.19 or EPC format is designated and the number of input digits of print data string is different from the size of the data to be formatted for the designated format, only the input data of designated size is formatted.

When a format is designated and data other than the one supported by the format, which has designated data string to be printed, is designated, a variable value is written.

⑥ Data type

When "conversion to binary" or "conversion to hexadecimal" is designated for the data type and the number of digits of print data string is less than that for the data type designated, the remaining digits are filled with "0", then an RFID write is performed. This also applies when a link field is designated. Each field must designate 1-byte data. If data of less than 1 byte is designated, shortfall of data must be filled with "0" and an RFID write is performed.

- ⑦ Designation of access password registration and kill password registration
When registration of access password or kill password fails, a registration error will result and the printer prints the void pattern.
This setting is effective only for the EPC Class 1 Generation 2 tag type and is ignored for other tag types. This setting may not be effective for some of the EPC Class 1 Generation 2 tags.
- ⑧ Lock./unlock setting
This setting is effective only for the EPC Class 1 Generation 2 tag type and is ignored for other tag types. This setting may not be effective for some of the EPC Class 1 Generation 2 tags.
- ⑨ Access to the password-protected tags
When “Access to the password-protected tags” is designated for an RFID write, the printer prints the void pattern if an access password for the RFID write does not match with the access password designated. Note that data can be written even onto password-protected tags when a designation of “Access to the password-protected tags” is omitted, but an access password cannot be registered when “Access to the password-protected tags” is designated.
This setting is effective only for the EPC Class 1 Generation 2 tag type and is ignored for other tag types. This setting may not be effective for some of the EPC Class 1 Generation 2 tags.

Notes

(1) The check digit attachment, increment/decrement, and zero suppress processes are performed according to the following priority. If any of the conditions is improper, no drawing will take place.

[For example, the zero(s) is replaced by a space(s) as a result of zero suppression but the modulus 10 designated to be attached cannot be calculated.]

Increment/decrement > zero suppression > attachment of check digit

(2) Up to 32 fields for which incrementing/decrementing has been designated can be drawn. If the total bit map font, outline font, and bar code increment/decrement fields exceeds 32, drawing will take place without incrementing/decrementing any excessive field. The field to be incremented or decremented is incremented or decremented until the Image Buffer Clear Command ([ESC] C) is transmitted.

[Example]

- ① Format Command (Increment bar code No. 01 (+1))
- ② Format Command (Increment bar code No. 02 (+2))
- ③ Image Buffer Clear Command
- ④ Data Command (Bar code No. 01 "0001")
- ⑤ Data Command (Bar code No. 02 "0100")
- ⑥ Issue Command (2 labels)



- ⑦ Issue Command (1 label)



- ⑧ Image Buffer Clear Command
- ⑨ Data Command (Bar code No. 02 "3000")
- ⑩ Issue Command (1 label)



- (3) More than one Bar Code Format Command can be connected when transmitted.

[ESC] XB01; 0100, 0150, 3, 1, 02, 02, 06, 06, 02, 0, 0150 [LF]
B02; 0350, 0150, 3, 1, 02, 02, 06, 06, 02, 0, 0150 [LF] [NUL]

- (4) When the drawing data is changed per label issue during printing, the field of the drawing data for the previous label is automatically cleared using the bar code number, then the next drawing data is printed. Therefore, the bar code number which differs according to the drawing fields should be designated. Since the automatic field clear is not performed between the Clear Command ([ESC] C) and Issue Command ([ESC] XS), the fixed data may be drawn using the same bar code number. In this case, the Format Command and Data Command should be sent alternately. (After the Issue Command is sent, the fields with the same bar code number are automatically cleared until the Clear Command is sent.)
- (5) The link field designation is cleared by omitting the link field designation using the same bar code No. and reformatting data.
The link field designation can also be cleared by the Image Buffer Clear Command.
- (6) A print data string and the link field No. cannot be programmed at the same time.

Refer to

Bit Map Font Format Command ([ESC] PC)
Outline Font Format Command ([ESC] PV)
Bar Code Data Command ([ESC] RB)

Examples

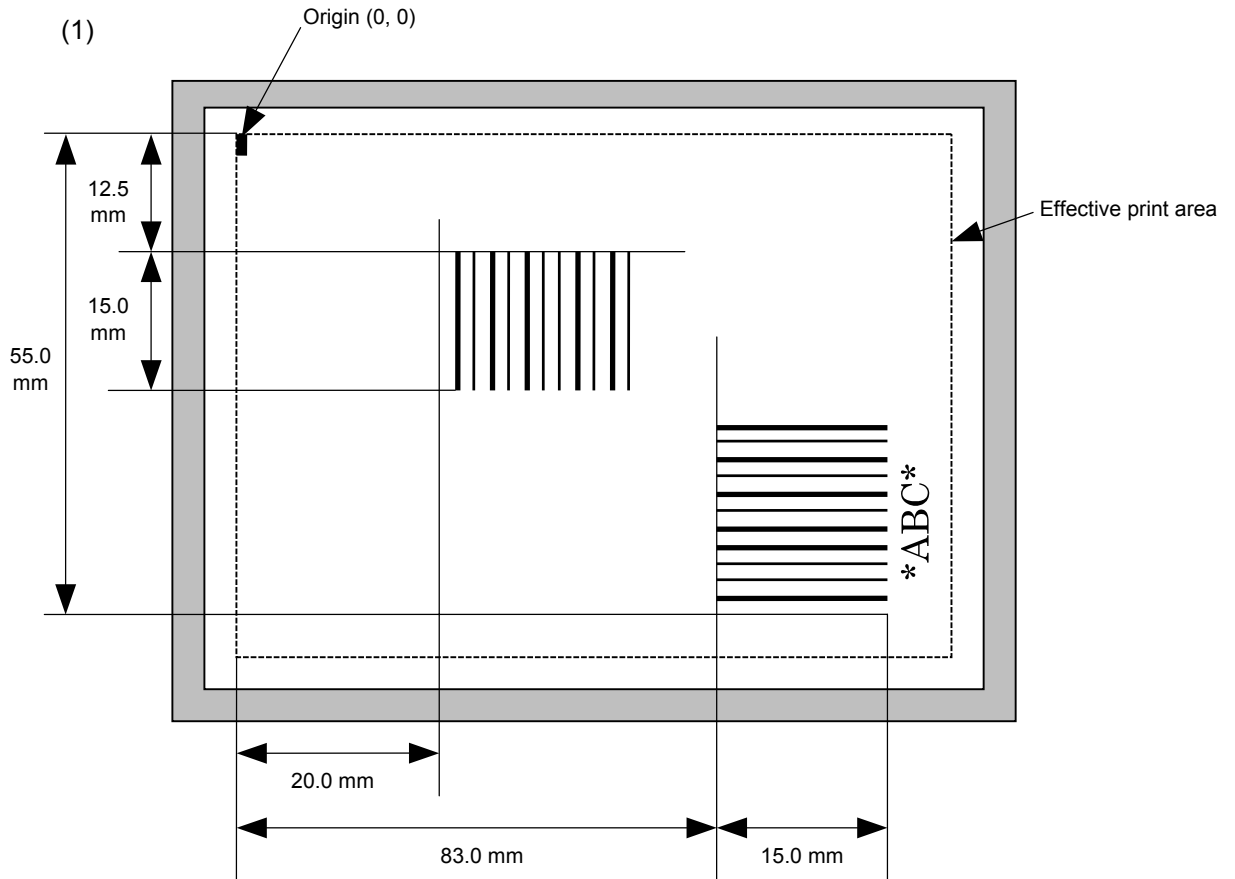

[ESC] C [LF] [NUL]

[ESC] XB01; 0200, 0125, 3, 1, 03, 03, 08, 08, 03, 0, 0150=12345 [LF] [NUL]

[ESC] XB02; 0830, 0550, 3, 1, 02, 04, 07, 08, 04, 3, 0150, +0000000000, 1, 00, N [LF] [NUL]

[ESC] RB02; *ABC* [LF] [NUL]

[ESC] XS; I, 0002, 0002C3000 [LF] [NUL]

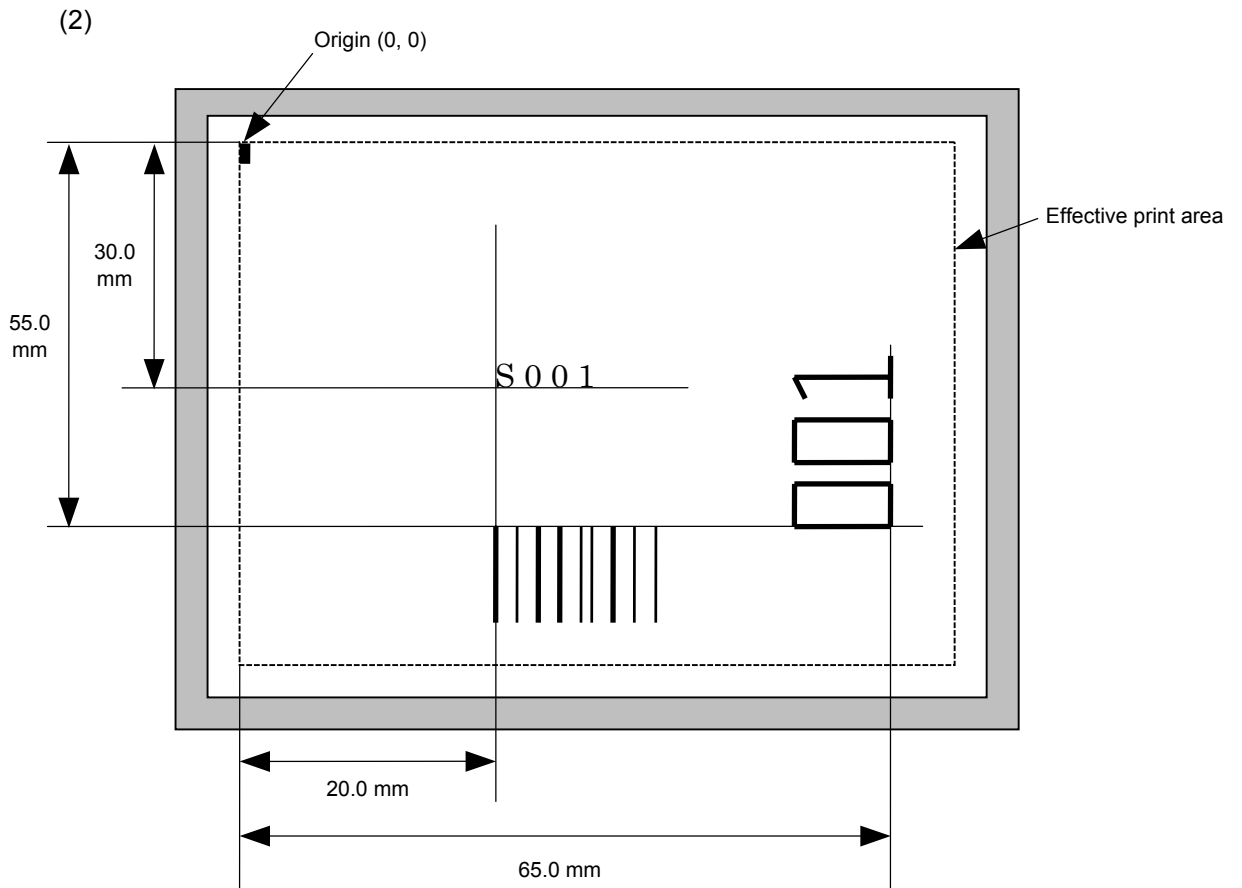

```
[ESC] C [LF] [NUL]
[ESC] PC001; 0200, 0300, 1, 1, C, 00, B; 01, 02 [LF] [NUL]
[ESC] PV01; 0650, 0550, 0200, 0150, B, 33, B; 02 [LF] [NUL]
[ESC] XB01; 0200, 0550, 3, 1, 03, 03, 08, 08, 03, 0, 0150; 01, 02 [LF] [NUL]
[ESC] RB; S [LF] 001 [LF] [NUL]
[ESC] XS; I, 0002, 0002C3000 [LF] [NUL]
```

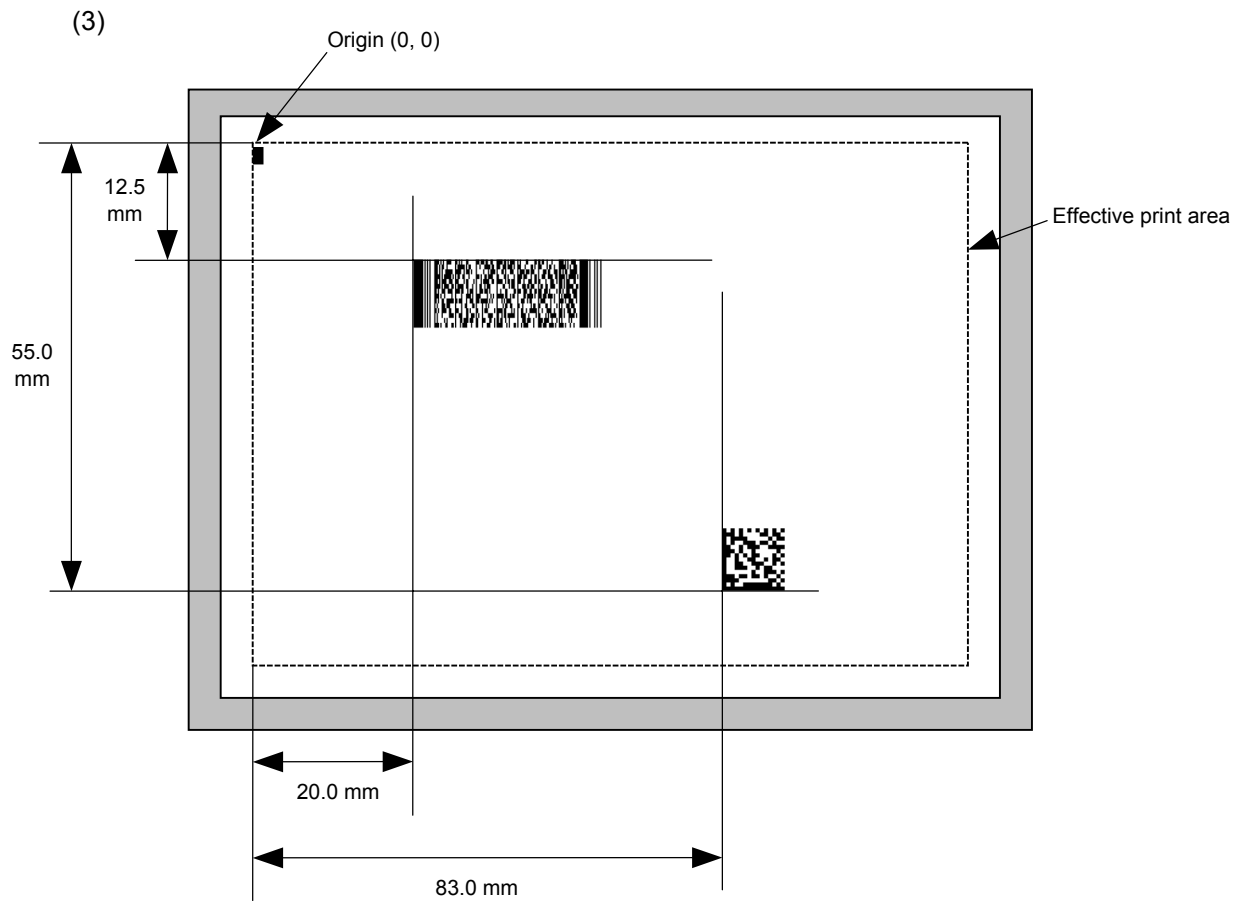

```
[ESC] C [LF] [NUL]
[ESC] XB01; 0200, 0125, P, 04, 02, 03, 0, 0010 [LF] [NUL]
[ESC] XB02; 0830, 0550, Q, 08, 03, 05, 3 [LF] [NUL]
[ESC] RB01; PDF417 [LF] [NUL]
[ESC] RB02; Data Matrix [LF] [NUL]
[ESC] XS; I, 0002, 0002C3000 [LF] [NUL]
```

6.3.11 BIT MAP FONT DATA COMMAND

[ESC] RC

Function	Provides data for the bit map font row.
Format	① [ESC] RCaaa; bbb ----- bbb [LF] [NUL] ② Link Field Data Command [ESC] RC; ccc ----- ccc [LF] ddd ----- ddd [LF] ----- [LF] xxx ----- xxx [LF] [NUL]
Term	aaa: Character string number 000 to 199 (Two digits, 00 to 99, also acceptable.) bbb ----- bbb: Data string to be printed Max. 255 digits (Max. 127 digits when the font type is e, j, 51, 52, 53, 54, or 55.) Any excess data will be discarded. For the character codes, refer to chapter 12 "CHARACTER CODE TABLE". ccc ----- ccc: Data string of link field No. 1 ddd ----- ddd: Data string of link field No. 2 to xxx ----- xxx: Data string of link field No. 99

Explanation	(1) Link field data string <ul style="list-style-type: none">• After the link field No. is designated in the Format Command, data strings are linked using the Link Field Data Command to draw an image.• Up to 255 digits of data strings can be linked. However, when the font type is e, j, 51, 52, 53, 54, or 55, only up to 127 digits can be linked. When the number of digits exceeds the maximum value, excess data will be discarded.• Up to 99 data strings can be linked.• Up to 2048 bytes can be used as the command length ([ESC] to [NUL]) of the Link Field Data Command.• When the data string is omitted in the Link Field Data Command, the following process is performed:<ul style="list-style-type: none">① No process will be performed for the field which contains no print data due to the omission.② When the field partially loses print data due to the omission, the only remaining data will be processed as print data.• The Link Field Data Command can be used for the bit map font fields, outline font fields, and bar code fields. (The same result is obtained when any of the "RC," "RV" or "RB" command code is designated.)
-------------	--

(2) Data string of Kanji code

- When the font type is e or j, Chinese Kanji is used. GB2312-80 can be printed.

(3) Kanji code selection

- The character code is automatically selected in the manner described below.

① GB2312-80 (Chinese Kanji)

- ⊙ 20h to A0h: Half-width character Other codes: GB2312-80

A: Kanji [中国]

[D6h] [D0h] [B9h] [FAh]
中 国

B: Kanji + Half-width character [中 ABC 国 abc]

[D6h] [D0h] [41h] [42h] [43h] [B9h] [FAh] [61h] [62h] [63h]
中 A B C 国 a b c

C: Half-width character [1 23ABC]

[31h] [32h] [33h] [41h] [42h] [43h]
1 2 3 A B C

(4) To mix Kanji and writable characters on the same field

- The character code should be specified in the manner described below.

① GB2312-80 (Chinese Kanji)

- ⊙ 20h to A0h: Half-width character Other codes: GB2312-80

A: Kanji [中国] + Writable character

[D6h] [D0h] [B9h] [FAh] [FAh] [A1h]
中 国 Writable character

B: Kanji + Half-width character [中 ABC 国 abc] + Writable character

[D6h] [D0h] [41h] [42h] [43h] [B9h] [FAh] [61h] [62h] [63h]
中 A B C 国 a b c

[FAh] [A1h]
Writable character

C: Half-width character [1 23ABC] + Writable character

[31h] [32h] [33h] [41h] [42h] [43h] [FAh] [A1h]
1 2 3 A B C Writable character

Refer to

Bit Map Font Format Command ([ESC] PC)

Examples

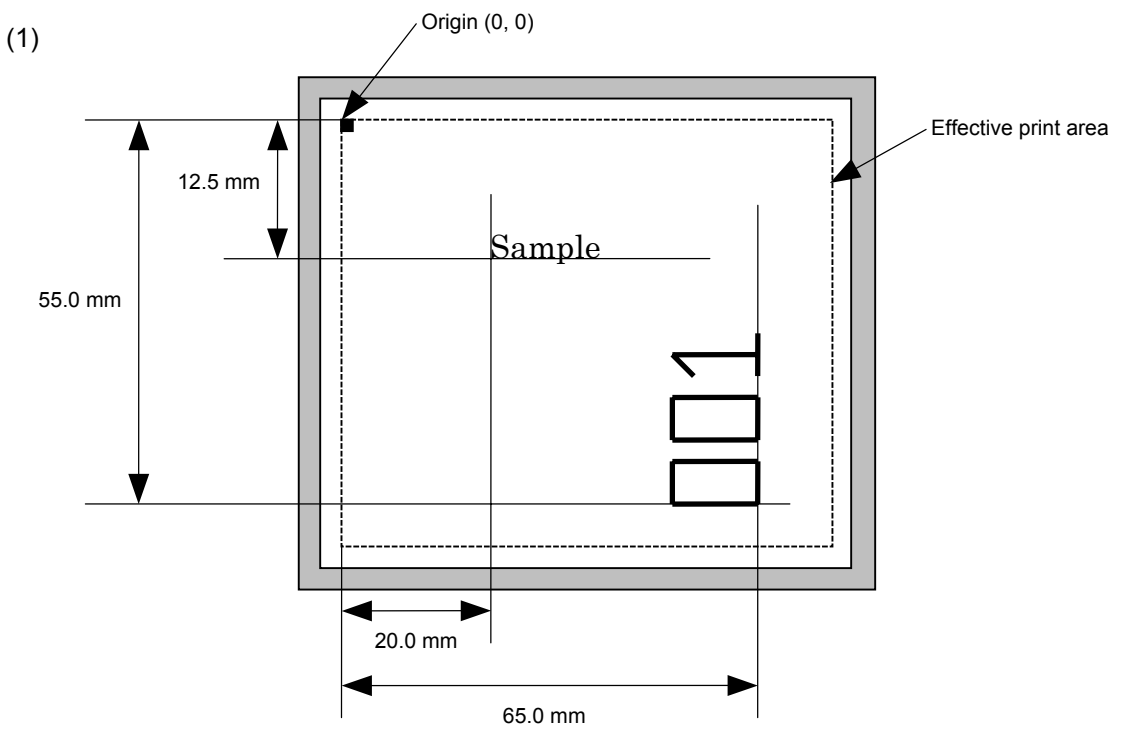

```
[ESC] C [LF] [NUL]  
[ESC] PC001; 0200, 0125, 1, 1, C, 00, B [LF] [NUL]  
[ESC] PC002; 0650, 0550, 2, 2, G, 33, B, +0000000001 [LF] [NUL]  
[ESC] RC001; Sample [LF] [NUL]  
[ESC] RC002; 001 [LF] [NUL]  
[ESC] XS; I, 0002, 0002C3000 [LF] [NUL]
```

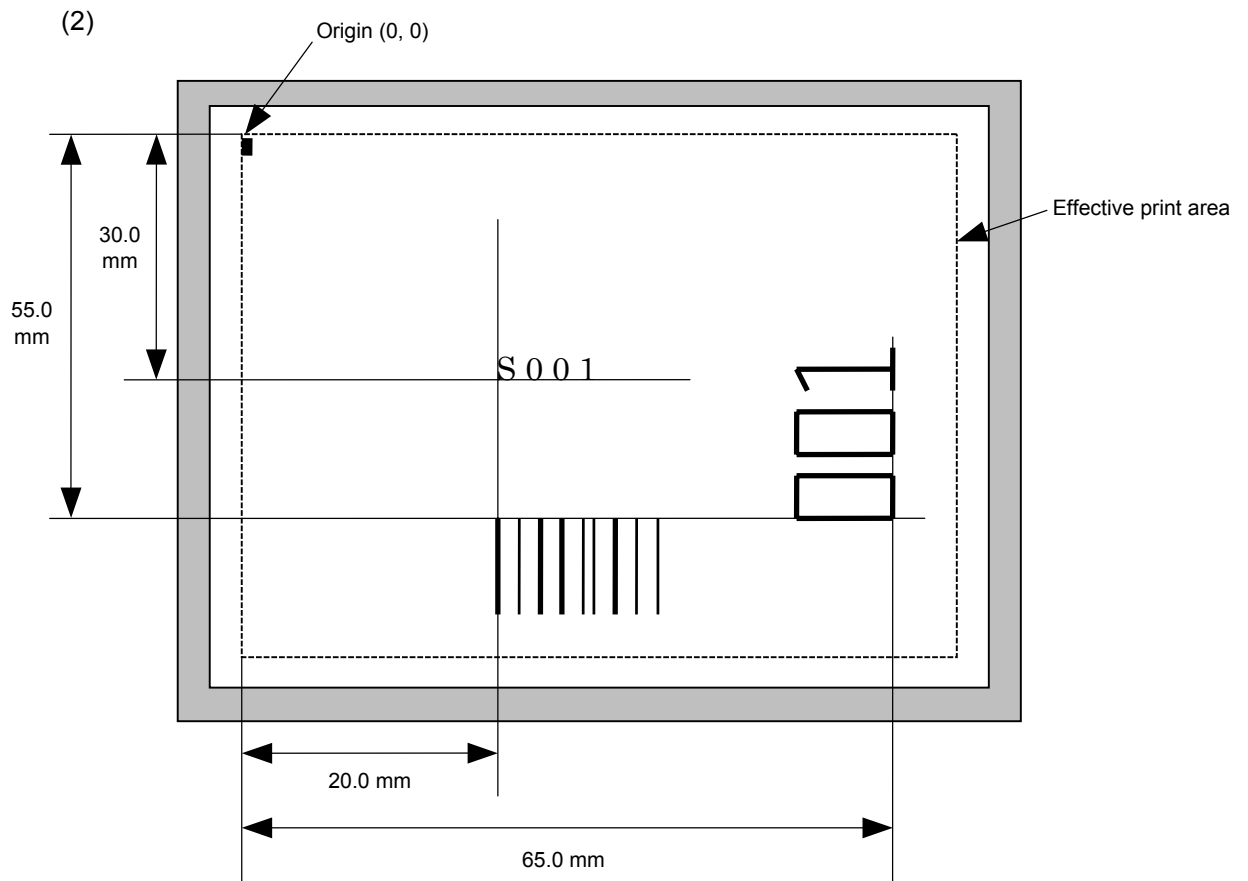

```
[ESC] C [LF] [NUL]
[ESC] PC001; 0200, 0300, 1, 1, C, 00, B; 01, 02 [LF] [NUL]
[ESC] PV01; 0650, 0550, 0200, 0150, B, 33, B; 02 [LF] [NUL]
[ESC] XB01; 0200, 0550, 3, 1, 03, 03, 08, 08, 03, 0, 0150; 01, 02 [LF] [NUL]
[ESC] RC; S [LF] 001 [LF] [NUL]
[ESC] XS; I, 0002, 0002C3000 [LF] [NUL]
```

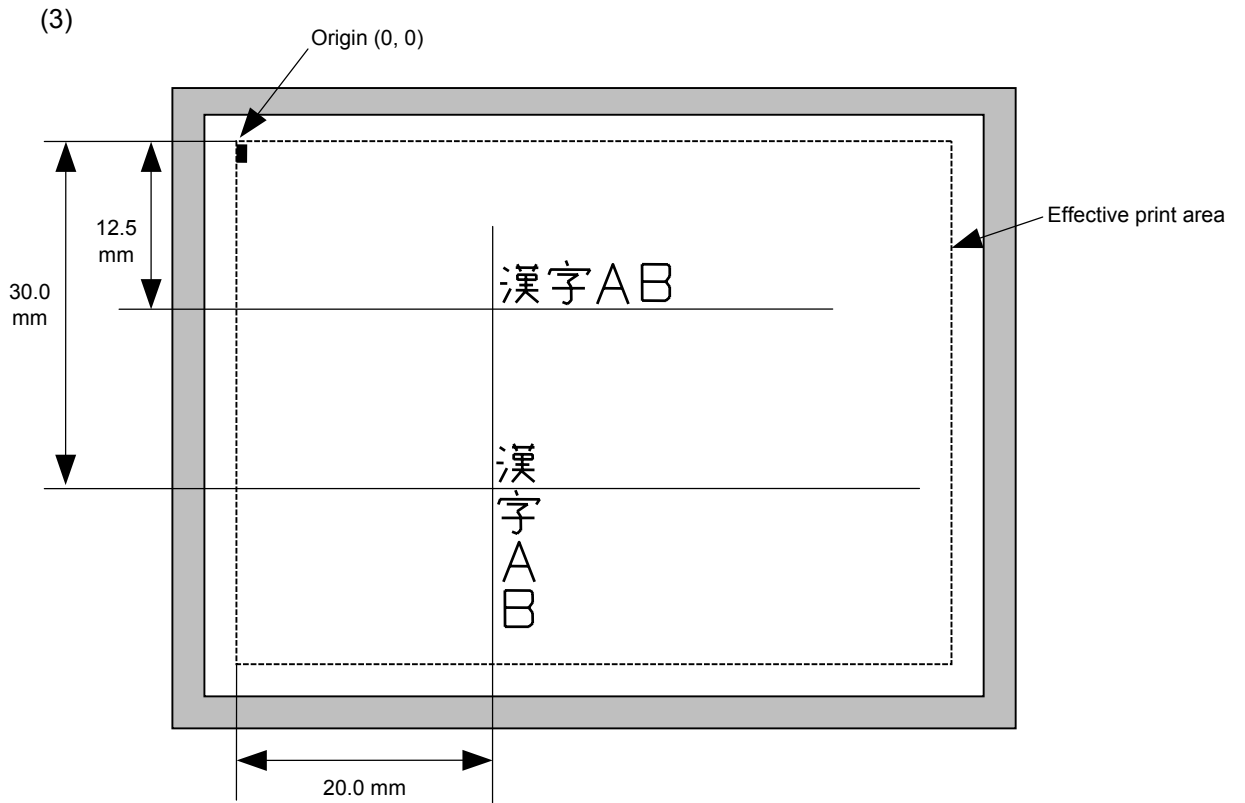

```
[ESC] C [LF] [NUL]
[ESC] PC000; 0200, 0125, 1, 1, X, 00, B [LF] [NUL]
[ESC] PC001; 0200, 0300, 1, 1, X, 01, B [LF] [NUL]
[ESC] RC000; 漢字    AB [LF] [NUL]
[ESC] RC001; 漢字    AB [LF] [NUL]
[ESC] XS; I, 0002, 0002C3000 [LF] [NUL]
```



6.3.12 OUTLINE FONT DATA COMMAND

[ESC] RV

Function	Provides data for the outline font row.
Format	① [ESC] RVaa; bbb ----- bbb [LF] [NUL] ② Link Field Data Command [ESC] RV; ccc ----- ccc [LF] ddd ----- ddd [LF] ----- [LF] xxx ----- xxx [LF] [NUL]
Term	aa: Character string number 00 to 99 bbb ----- bbb: Data string to be printed Max. 255 digits Any excess data will be discarded. For the character codes, refer to chapter 12 "CHARACTER CODE TABLE". ccc ----- ccc: Data string of link field No. 1 ddd ----- ddd: Data string of link field No. 2 to xxx ----- xxx: Data string of link field No. 99
Explanation	(1) Link field data string <ul style="list-style-type: none">• After the link field No. is designated in the Format Command, data strings are linked using the Link Field Data Command to draw an image.• Up to 255 digits of data strings can be linked. Data exceeding the max. number of digits will be discarded.• Up to 99 data strings can be linked.• Up to 2048 bytes can be used as the command length ([ESC] to [NUL]) of the Link Field Data Command.• When the data string is omitted in the Link Field Data Command, the following process is performed:<ul style="list-style-type: none">① No process will be performed for the field which contains no print data due to the omission.② When the field partially loses print data due to the omission, the only remaining data will be processed as print data.• The Link Field Data Command can be used for the bit map font fields, outline font fields, and bar code fields. (The same result is obtained when any of the "RC," "RV" or "RB" command code is designated.)
Refer to	Outline Font Format Command ([ESC] PV)

Examples

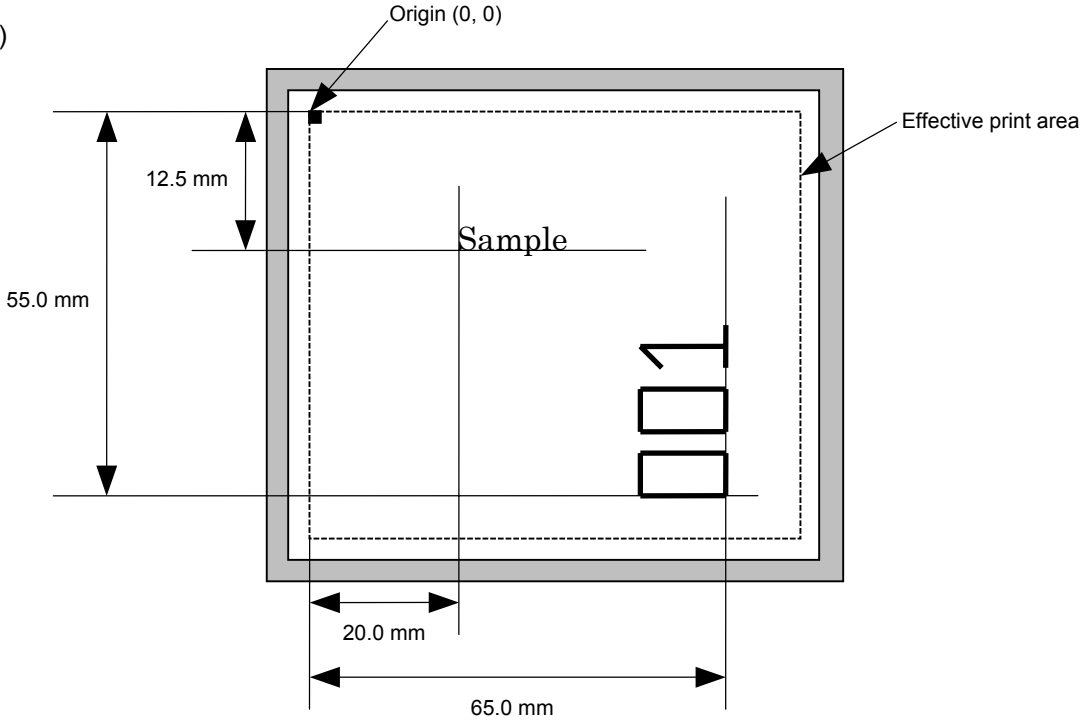
(1)



```
[ESC] C [LF] [NUL]  
[ESC] PV01; 0200, 0125, 0100, 0100, B, 00, B [LF] [NUL]  
[ESC] PV02; 0650, 0550, 0200, 0150, B, 33, B, +0000000001 [LF] [NUL]  
[ESC] RV01; Sample [LF] [NUL]  
[ESC] RV02; 001 [LF] [NUL]  
[ESC] XS; I, 0002, 0002C3000 [LF] [NUL]
```

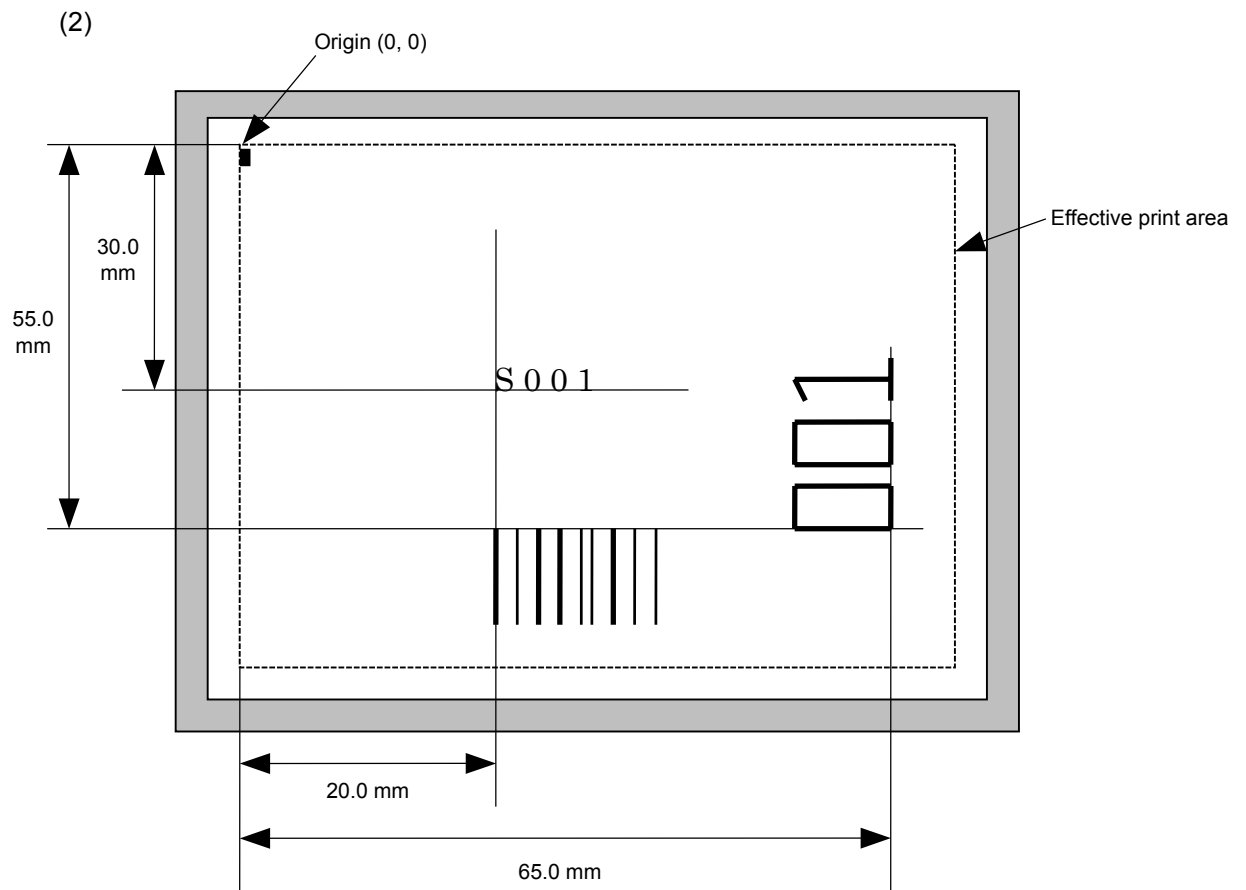

```
[ESC] C [LF] [NUL]
[ESC] PC001; 0200, 0300, 1, 1, C, 00, B; 01, 02 [LF] [NUL]
[ESC] PV01; 0650, 0550, 0200, 0150, B, 33, B; 02 [LF] [NUL]
[ESC] XB01; 0200, 0550, 3, 1, 02, 02, 06, 06, 02, 0, 0150; 01, 02 [LF] [NUL]
[ESC] RC; S [LF] 001 [LF] [NUL]
[ESC] XS; I, 0002, 0002C3000 [LF] [NUL]
```

6.3.13 BAR CODE DATA COMMAND

[ESC] RB

Function	Provides data for the bar code.																				
Format	<p>① [ESC] RBaa; bbb ----- bbb [LF] [NUL]</p> <p>② Link Field Data Command [ESC] RB; ccc ----- ccc [LF] ddd ----- ddd [LF] ----- [LF] xxx ----- xxx [LF] [NUL]</p>																				
Term	<p>aa: Bar code number 00 to 31</p> <p>bbb ----- bbb: Data string to be printed The maximum number of digits varies according to the type of bar code.</p> <p>ccc ----- ccc: Data string of link field No. 1</p> <p>ddd ----- ddd: Data string of link field No. 2 to</p> <p>xxx ----- xxx: Data string of link field No. 99</p> <p>The Data Command for the MaxiCode is described later.</p>																				
Explanation	<p>(1) Data check</p> <p>If there is data in the data row, which does not meet the type of bar code, the bar code will not be drawn. If wrong code selection takes place in the data row of CODE128 (without auto code selection), the bar code will not be drawn.</p> <p>If there is data different from the one designated using the format ID when Data Matrix is used, the symbol is not drawn.</p> <p>(2) No. of digits of data</p> <p>When data exceeding the maximum number of digits is sent, the excess data will be discarded. For the maximum number of digits for each bar code, see below.</p> <table style="margin-left: 40px;"> <tr> <td>Data Matrix, PDF417, QR code:</td> <td>2000 digits</td> </tr> <tr> <td>CP code:</td> <td>473 digits</td> </tr> <tr> <td>MicroPDF417:</td> <td>366 digits</td> </tr> <tr> <td>MaxiCode:</td> <td>93 digits</td> </tr> <tr> <td>Customer bar code:</td> <td>20 digits</td> </tr> <tr> <td>Highest priority customer bar code:</td> <td>19 digits</td> </tr> <tr> <td>POSTNET:</td> <td>5, 9, 11 digits</td> </tr> <tr> <td>ROYAL MAIL 4 STATE CUSTOMER CODE:</td> <td>12 digits</td> </tr> <tr> <td>KIX CODE:</td> <td>18 digits</td> </tr> <tr> <td>Bar codes other than the above</td> <td>126 digits</td> </tr> </table> <p>When the number of digits does not correspond to the bar code type, the bar code is not drawn.</p> <p>For the MaxiCode, the maximum number of digits varies according to the mode. In mode 2 or 3 and mode 4 or 6, the maximum number of digits is 84 and 93, respectively.</p>	Data Matrix, PDF417, QR code:	2000 digits	CP code:	473 digits	MicroPDF417:	366 digits	MaxiCode:	93 digits	Customer bar code:	20 digits	Highest priority customer bar code:	19 digits	POSTNET:	5, 9, 11 digits	ROYAL MAIL 4 STATE CUSTOMER CODE:	12 digits	KIX CODE:	18 digits	Bar codes other than the above	126 digits
Data Matrix, PDF417, QR code:	2000 digits																				
CP code:	473 digits																				
MicroPDF417:	366 digits																				
MaxiCode:	93 digits																				
Customer bar code:	20 digits																				
Highest priority customer bar code:	19 digits																				
POSTNET:	5, 9, 11 digits																				
ROYAL MAIL 4 STATE CUSTOMER CODE:	12 digits																				
KIX CODE:	18 digits																				
Bar codes other than the above	126 digits																				

The maximum number of digits for Data Matrix varies according to the settings for ECC type, format ID, and the cell size. In the case of Kanji, the maximum number of digits is half those of the values described below since a Kanji character occupies 2 bytes.

Max number of digits for Data Matrix

	ECC0	ECC50	ECC80	ECC100	ECC140
Format ID 1	500	457	402	300	144
Format ID 2	452	333	293	218	105
Format ID 3	394	291	256	190	91
Format ID 4	413	305	268	200	96
Format ID 5	310	228	201	150	72
Format ID 6	271	200	176	131	63

	Numeric	Alphanumeric	8 bit
ECC200	2000	2000	1556

The maximum writable data volume on the RFID is 512 bytes. However, the actually writable data volume varies according to the type of tag to be used.

Cell Size and Effective Data Capacity

Symbol size		ECC000			ECC050			ECC080			ECC100			ECC140		
		Numeric capacity	Alphanum capacity	8-bit byte capacity	Numeric capacity	Alphanum capacity	8-bit byte capacity	Numeric capacity	Alphanum capacity	8-bit byte capacity	Numeric capacity	Alphanum capacity	8-bit byte capacity	Numeric capacity	Alphanum capacity	8-bit byte capacity
Row	Col															
9	9	3	2	1	–	–	–	–	–	–	–	–	–	–	–	–
11	11	12	8	5	1	1	–	–	–	–	–	–	–	–	–	–
13	13	24	16	10	10	6	4	4	3	2	1	1	–	–	–	–
15	15	37	25	16	20	13	9	13	9	6	8	5	3	–	–	–
17	17	53	35	23	32	21	14	24	16	10	16	11	7	2	1	1
19	19	72	48	31	46	30	20	36	24	16	25	17	11	6	4	3
21	21	92	61	40	61	41	27	50	33	22	36	24	15	12	8	5
23	23	115	76	50	78	52	34	65	43	28	47	31	20	17	11	7
25	25	140	93	61	97	65	42	82	54	36	60	40	26	24	16	10
27	27	168	112	73	118	78	51	100	67	44	73	49	32	30	20	13
29	29	197	131	86	140	93	61	120	80	52	88	59	38	38	25	16
31	31	229	153	100	164	109	72	141	94	62	104	69	45	46	30	20
33	33	264	176	115	190	126	83	164	109	72	121	81	53	54	36	24
35	35	300	200	131	217	145	95	188	125	82	140	93	61	64	42	28
37	37	339	226	148	246	164	108	214	143	94	159	106	69	73	49	32
39	39	380	253	166	277	185	121	242	161	106	180	120	78	84	56	36
41	41	424	282	185	310	206	135	270	180	118	201	134	88	94	63	41
43	43	469	313	205	344	229	150	301	201	132	224	149	98	106	70	46
45	45	500	345	226	380	253	166	333	222	146	248	165	108	118	78	51
47	47	500	378	248	418	278	183	366	244	160	273	182	119	130	87	57
49	49	500	413	271	457	305	200	402	268	176	300	200	131	144	96	63

Symbol size		ECC200		
		Numeric capacity	Alphanum capacity	8-bit byte capacity
Row	Col			
10	10	6	3	1
12	12	10	6	3
14	14	16	10	6
16	16	24	16	10
18	18	36	25	16
20	20	44	31	20
22	22	60	43	28
24	24	72	52	34
26	26	88	64	42
32	32	124	91	60
36	36	172	127	84
40	40	228	169	112
44	44	288	214	142
48	48	348	259	172
52	52	408	304	202
64	64	560	418	278
72	72	736	550	366
80	80	912	682	454
88	88	1152	862	574
96	96	1392	1042	694
104	104	1632	1222	814
120	120	2000	1573	1048
132	132	2000	1954	1302
144	144	2000	2000	1556

Rectangular code

Symbol size		ECC200		
		Numeric capacity	Alphanum capacity	8-bit byte capacity
Row	Col			
8	18	10	6	3
8	32	20	13	8
12	26	32	22	14
12	36	44	31	20
16	36	64	46	30
16	48	98	72	47

When PDF417 or MicroPDF417 is used, the number of symbol characters called code words is limited to 928 or less. Moreover, the data compression rate varies according to the contents of data. Therefore, the maximum number of digits according to modes is as follows.

When letters and numerics are mixed in data in EXC mode, for example, the maximum values become smaller than the values below, since the internal mode selection code is used.

To correct a reading error by designating the security level, the maximum value becomes smaller, since the error correction code words below are used.

When the number of the code words exceeds 928, or when the number of rows exceeds 90, the symbols are not drawn.

For the MicroPDF417, the numbers of rows and columns can be specified.

The maximum number of digits varies according to the setting.

In the case of PDF417

- Extended Alphanumeric Compaction (EXC) mode: 1850 digits
- Binary/ASCII Plus mode: 1108 digits
- Numeric compaction mode: 2000 digits

In the case of MicroPDF417

- Binary mode: 150 digits
- Upper case letter/space mode: 250 digits
- Numeric compaction mode: 366 digits

No. of Error Correction Code Words of PDF417

(For the MicroPDF417, the printer sets the security level automatically.)

Security level	Error Correction Ability	No. of error correction code words
Level 0	<div style="display: flex; flex-direction: column; align-items: center;"> <div style="border: 1px solid black; padding: 5px; margin-bottom: 10px;">Low</div> <div style="border-top: 1px solid black; border-bottom: 1px solid black; width: 20px; height: 20px; margin: 0 5px;"></div> <div style="border: 1px solid black; padding: 5px; margin-top: 10px;">High</div> </div>	0
Level 1		2
Level 2		6
Level 3		14
Level 4		30
Level 5		62
Level 6		126
Level 7		254
Level 8		510

The maximum number of columns and rows for the MicroPDF417

Parameter (gg)	No. of columns	No. of rows	Max. number of digits for binary mode	Max. number of digits for upper case letter/space mode	Max. number of digits for numeric mode
00	–	–	150	250	366
01	1	–	22	38	55
02	2	–	43	72	105
03	3	–	97	162	237
04	4	–	150	250	366
05	1	11	3	6	8
06		14	7	12	17
07		17	10	18	26
08		20	13	22	32
09		24	18	30	44
10		28	22	38	55
11	2	8	8	14	20
12		11	14	24	35
13		14	21	36	52
14		17	27	46	67
15		20	33	56	82
16		23	38	64	93
17		26	43	72	105
18	3	6	6	10	14
19		8	10	18	26
20		10	15	26	38
21		12	20	34	49
22		15	27	46	67
23		20	39	66	96
24		26	54	90	132
25		32	68	114	167
26		38	82	138	202
27		44	97	162	237
28	4	4	8	14	20
29		6	13	22	32
30		8	20	34	49
31		10	27	46	67
32		12	34	58	85
33		15	45	76	111
34		20	63	106	155
35		26	85	142	208
36		32	106	178	261
37		38	128	214	313
38		44	150	250	366

(3) CODE128 code selection

In the case of CODE128 (with auto code selection), code selection is performed in the following manner. (Conforming to USS-128 APPENDIX-G)

- ① Determining the start character
 - (a) If the data begins with four or more consecutive numerals, the start code to be used is (CODE C).
 - (b) In any case other than (a) in ①, if a control character appears before a small letter (see ④.) or four or more consecutive numerals, the start code is (CODE A).
 - (c) In none of the above cases, the start code is (CODE B).
- ② If the data begins with an odd number of digits in (a), ①:
 - (a) Insert the (CODE A) or (CODE B) character just before the last numeric data. When (FNC1), if found in the number, breaks a pair of digits in the number, insert the (CODE A) or (CODE B) character before the numeric data preceding the (FNC1). Selection of (CODE A) or (CODE B) should conform to (b) and (c) in ①.
- ③ If four or more digits of numeric data continue in (CODE A) or (CODE B).
 - (a) When the numeric data is an even number of digits, insert the (CODE C) character just before the first numeric data.
 - (b) When the numeric data is an odd number of digits, insert the (CODE C) character immediately after the first numeric data.
- ④ If a control character appears in (CODE B):
 - (a) In the subsequent data, when a small letter appears before the next control character or four or more consecutive digits, insert the (SHIFT) character before the first control character.
 - (b) When not so, insert the (CODE B) character just before the first control character.
- ⑤ If a small letter appears in (CODE A):
 - (a) In the subsequent data, when a control character appears before the next small letter or four or more consecutive digits, insert the (SHIFT) character before the first small letter.
 - (b) When not so, insert the (CODE B) character just before the first small letter.
- ⑥ If any data other than the numerals appears in (CODE C):
 - (a) Insert the (CODE A) or (CODE B) character just before the data other than the numerals. Selection of (CODE A) or (CODE B) should conform to (b) and (c) in ①.

(4) CODE128 code selection check

Check if selection of (CODE A), (CODE B), or (CODE C) of CODE128 has been set correctly. If an error is found, the bar code will not be drawn.

[Conditions causing an error]

- ① No start code is designated.
- ② A small letter (including { , | , } , ~ , _) is found in (CODE A).
- ③ A control character is found in (CODE B).
- ④ Any data other than the numerals, (FNC1), (CODE A), and (CODE B) is found in (CODE C).
- ⑤ There are two or more consecutive (SHIFT) characters.
- ⑥ The number in (CODE C) is an odd number of digits.
- ⑦ (SHIFT) is followed by (CODE A), (CODE B) or (CODE C).

(5) Kanji code selection

- In the case of Data Matrix, PDF417, and QR code, Kanji codes can be printed. Shift JIS, JIS hexadecimal, JIS 8 codes can be mixed.

(6) Link field data string

- After the link field No. is designated in the Format Command, data strings are linked using the Link Field Data Command to draw an image.
- Up to 2000 digits of data strings of Data Matrix and PDF417 can be linked. For other bar codes, up to 126 digits can be linked. (The value varies according to the type of bar code.)
When the number of digits exceeds the maximum value, excess data will be discarded.
- Up to 99 data strings can be linked.
- Up to 2048 bytes can be used as the command length ([ESC] to [NUL]) of the Link Field Data Command.
- When the data string is omitted in the Link Field Data Command, the following process is performed:
 - ① No process will be performed for the field which contains no print data due to the omission.
 - ② When the field partially loses print data due to the omission, the only remaining data will be processed as print data.
- The Link Field Data Command can be used for the bit map font fields, outline font fields, and bar code fields.
(The same result is obtained when any of the "RC," "RV", or "RB" command code is designated.)

(7) When manual mode is selected in the Format Command for a QR code

① Numeric mode, alphanumeric and symbol mode, Kanji mode

Mode selection	Data to be printed
----------------	--------------------

② Binary mode

Mode selection	No. of data strings (4 digits)	Data to be printed
----------------	-----------------------------------	--------------------

③ Mixed mode

Data	“,” (comma)	Data	“,” (comma)	Data
------	-------------	------	-------------	------

The QR code can handle all codes including alphanumerics, symbols and Kanji. Since data compression rate varies according to codes, the code to be used is designated when the mode is selected.

Mode	Code	Details
N	Numerals	0 to 9
A	Alphanumerics, symbols	A to Z 0 to 9 space \$ % * + - . / :
B	Binary (8-bit)	00H to FFH
K	Kanji	Shift JIS, JIS hexadecimal

If mixed mode is selected, up to 200 modes can be selected in a QR code.

(8) When the automatic mode is selected in the Format Command for a QR code.

Data to be printed

(9) How to transmit the control code data

NUL (00H)	=	> @ (3EH, 40H)
SOH (01H)	=	> A (3EH, 41H)
STX (02H)	=	> B (3EH, 42H)
⋮		
GS (1DH)	=	>] (3EH, 5DH)
RS (1EH)	=	> ^ (3EH, 5EH)
US (1FH)	=	> _ (3EH, 5FH)

* How to transmit the special codes

> (3EH)	=	> 0 (3EH, 30H)
---------	---	----------------

(10) Transfer code for QR code

	0	1	2	3	4	5	6	7	8	9	A	B	C	D	E	F
0	NUL	DLE	SP	0	@	P	`	p								
1	SOH	DC1	!	1	A	Q	a	q								
2	STX	DC2	"	2	B	R	b	r								
3	ETX	DC3	#	3	C	S	c	s								
4	EOT	DC4	\$	4	D	T	d	t								
5	ENQ	NAK	%	5	E	U	e	u								
6	ACK	SYN	&	6	F	V	f	v								
7	BEL	ETB	'	7	G	W	g	w								
8	BS	CAN	(8	H	X	h	x								
9	HT	EM)	9	I	Y	i	y								
A	LF	SUB	*	:	J	Z	j	z								
B	VT	ESC	+	;	K	[k	{								
C	FF	FS	,	<	L	\	l									
D	CR	GS	-	=	M]	m	}								
E	SO	RS	•	>	N	^	n	~								
F	SI	US	/	?	O	_	o	DEL								

* The shaded parts are Japanese. They are omitted here.

(11) Examples of data designation

① Alphanumeric mode: ABC123

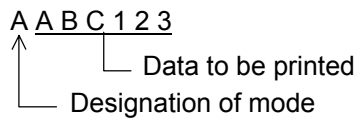

② Binary mode: 01H, 03H, 05H

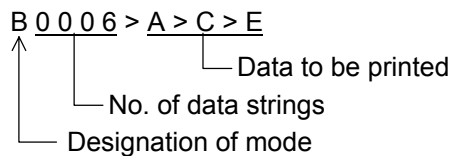

③ Mixed mode

Numeric mode : 123456
 Kanji mode : Kanji data
 Binary mode : aア iイ uウ eエ oオ
 Alphanumeric mode : ABC

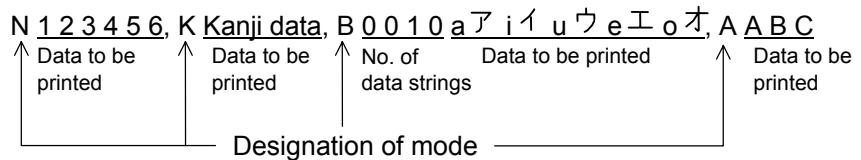

④ Automatic mode

When the data above (③) is designated in automatic mode:

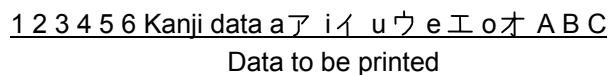

(12) MaxiCode data

For mode 2 or 3:

[ESC] RBaa; bbbbbbccccdddeeee --- eeeee [LF] [NUL]

For mode 4 or 6:

[ESC] RBaa; ffffffffggggg --- ggggg [LF] [NUL]

- | | | | |
|---|---------------|--------------------------------|---|
| ① | bbbbbb: | Postal code | Fixed as 9 digits |
| • | Mode 2: | | |
| | b1b2b3b4b5: | Zip code | Fixed as 5 digits (Numerics) |
| | b6b7b8b9: | Zip code extension | Fixed as 4 digits (Numerics) |
| • | Mode 3: | | |
| | b1b2b3b4b5b6: | Zip code | Fixed as 6 digits (Character "A" of code set) |
| | b7b8b9: | Vacant | Fixed as 3 digits (20H) |
| ② | ccc: | Class of service | Fixed as 3 digits (Numerics) |
| ③ | ddd: | Country code | Fixed as 3 digits (Numerics) |
| ④ | eee --- eee: | Message data strings | 84 digits |
| ⑤ | fffffff: | Primary message data strings | 9 digits |
| ⑥ | ggg --- ggg: | Secondary message data strings | 84 digits |

- NOTES:**
1. When anything other than numerics is included in the data string of zip code (mode 2), zip code extension, class of service, or country code, a MaxiCode is not drawn.
 2. If the message data is less than 84 digits when mode 2 or 3 is selected, the printer adds a CR (000000) at the end of the data, and the remaining digits will be padded with FSs (011100). When message data exceeding 84 digits is received, the excess data will be discarded before drawing a MaxiCode.
 3. If the message data is less than 93 digits (9 digits + 84 digits) when mode 4 or 6 is selected, the printer adds a CR (000000) at the end of the data, and the remaining digits will be padded with FSs (011100). When message data exceeding 93 digits is received, the excess data will be discarded before drawing a MaxiCode.
 4. Mode 6 should not be used for usual operation since it is used for scanner programming.
 5. When "TYPE2: Special specification" is set for MaxiCode specification setting in the system mode and when Mode 2 is selected, the country code must be 840. Otherwise, a MaxiCode will not be printed.
 6. When "TYPE2: Special specification" is set for MaxiCode specification setting in the system mode and when Mode 3 is selected, the country code must be other than 840. Otherwise, a MaxiCode will not be printed.

Examples

(1)

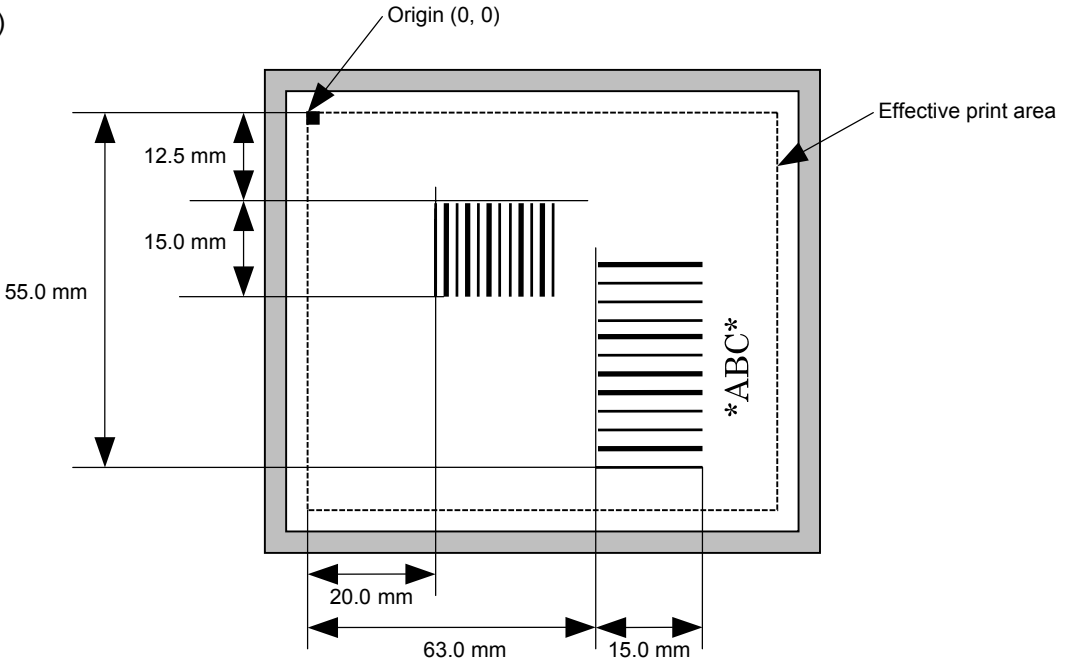

```
[ESC] C [LF] [NUL]  
[ESC] XB01; 0200, 0125, 3, 1, 02, 02, 06, 06, 02, 0, 0150 [LF] [NUL]  
[ESC] XB02; 0830, 0550, 3, 1, 02, 04, 07, 08, 04, 3, 0150, +0000000000, 1, 00, N [LF] [NUL]  
[ESC] RB01; 12345 [LF] [NUL]  
[ESC] RB02; *ABC* [LF] [NUL]  
[ESC] XS; I, 0002, 0002C3000 [LF] [NUL]
```

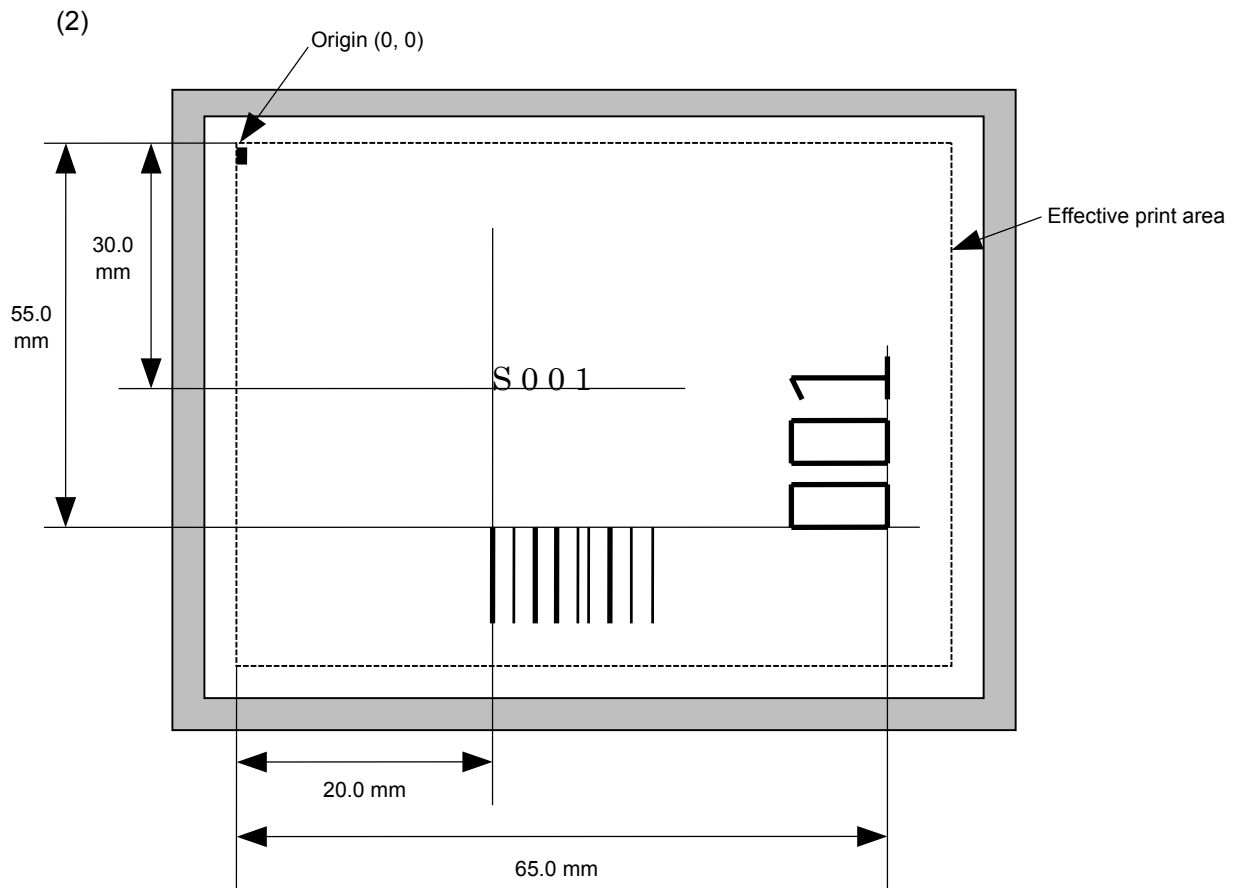

```
[ESC] C [LF] [NUL]
[ESC] PC001; 0200, 0300, 1, 1, C, 00, B; 01, 02 [LF] [NUL]
[ESC] PV01; 0650, 0550, 0200, 0150, B, 33, B; 02 [LF] [NUL]
[ESC] XB01; 0200, 0550, 3, 1, 02, 02, 06, 06, 02, 0, 0150; 01, 02 [LF] [NUL]
[ESC] RB; S [LF] 001 [LF] [NUL]
[ESC] XS; I, 0002, 0002C3000 [LF] [NUL]
```

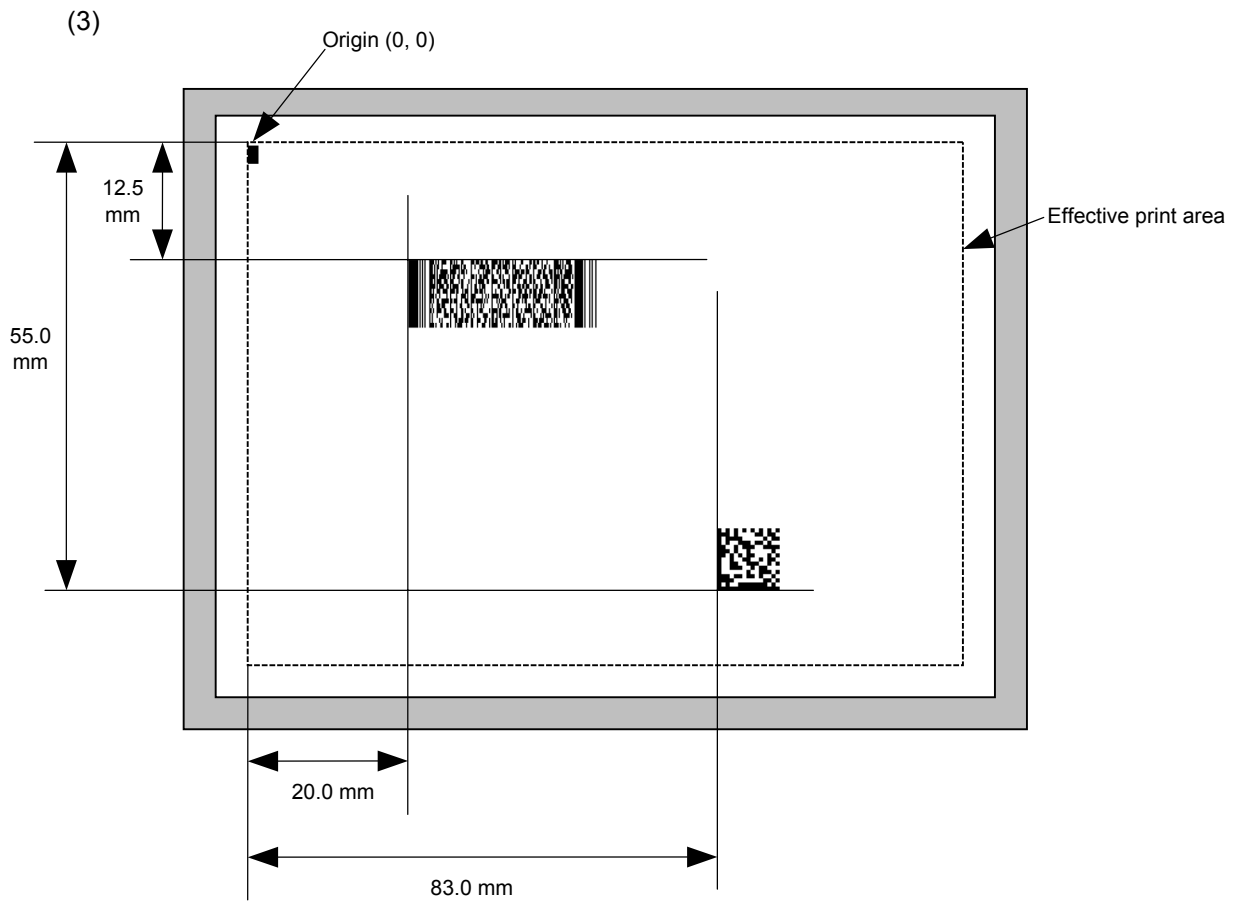

```
[ESC] C [LF] [NUL]
[ESC] XB01; 0200, 0125, P, 04, 02, 03, 0, 0010 [LF] [NUL]
[ESC] XB02; 0830, 0550, Q, 08, 03, 05, 3 [LF] [NUL]
[ESC] RB01; PDF417 [LF] [NUL]
[ESC] RB02; Data Matrix [LF] [NUL]
[ESC] XS; I, 0002, 0002C3000 [LF] [NUL]
```

6.3.14 ISSUE COMMAND

[ESC] XS

Function	Issues labels according to the print conditions programmed.
Format	[ESC] XS; l, aaaa, bbbcd efgh [LF] [NUL]
Term	<p>aaaa: Number of labels to be issued 0001 to 9999</p> <p>bbb: Cut interval. Designates the number of pieces to be printed before the backing paper is cut. 000 to 100 (no cut when 000)</p> <p>c: Type of sensor 0: No sensor 1: Reflective sensor 2: Transmissive sensor (when using normal labels) 3: Transmissive sensor (when using preprinted labels) 4: Reflective sensor (when using a manual threshold value)</p> <p>d: Issue mode C: Batch mode D: Strip mode (with back feed, the strip sensor is valid.) E: Strip mode (with back feed, the strip sensor is ignored, the applicator supports this mode.)</p> <p>e: Issue speed B-SX4T: B-SX5T: 3: 3 ips 3: 3 ips 6: 6 ips 5: 5 ips A: 10 ips 8: 8 ips</p> <p>f: With/without ribbon 0: Without ribbon 1: With ribbon (with ribbon saving function) 2: With ribbon (without ribbon saving function) 3: With ribbon (with head up function)</p> <p>g: Designates tag rotation. 0: Printing bottom first 1: Printing top first 2: Mirror printing bottom first 3: Mirror printing top first</p> <p>h: Type of status response 0: No status response 1: Status response</p>

Explanation

(1) Number of labels to be issued

- ① If increment/decrement is not specified, the designated number of pieces with the same drawing data will be issued.
- ② If increment/decrement is specified, the designated number of pieces will be issued while incrementing/decrementing the piece of the designated drawing area.
 - * The increment/decrement designation is valid until the Image Buffer Clear Command ([ESC] C) is transmitted.

(2) Cut interval

The cut interval is valid only when the cutter has been installed and the issue mode is "C". If an error occurs during an issue after the cut interval is designated, and then printing is restarted, the printer ejects the printed paper, then resumes printing on the paper where the error occurred.

If no subsequent command is received from the PC for 1 second after issuing the last label, the printer automatically performs an approximately 13.7-mm forward feed. However, if the label pitch length is 20 mm or less, the edge of the label is caught on the head, when the label is fed back to the home position. Therefore, even if the automatic forward feed standby is specified, a forward feed is not performed.

When receiving the Issue Command during the automatic forward feed standby, the printer starts an issue after a reverse feed to the original position.

If any command is sent and processed after the Issue Command is sent, the automatic forward feed is not performed. Therefore, a command should not be sent after the Issue Command is sent. The power should not be turned off then on, or the printer should not be placed in a pause/reset state before the automatic forward feed, since the automatic forward feed is not performed when the paper is fed by turning the power off then on, or by pressing the [FEED] key of the printer in the pause/reset state.

If the paper is fed by pressing the [FEED] key of the printer during the forward feed standby, the printer feeds one label, cuts, performs the automatic forward feed then stops.

When writing data onto the RFID tag failed and the void pattern is printed, the paper including the void one is cut at the specified cut interval.

(3) Type of sensor

- ① No sensor: Printing takes place according to the parameter designated by the Label Size Set Command.
- ② Reflective sensor:

Printing takes place according to the parameter designated by the Label Size Set Command. However, the black mark provided on the back side of the tag paper is automatically sensed by the reflective sensor and the paper position is finely adjusted for every piece.
- ③ Transmissive sensor (when using normal labels):

Printing takes place according to the parameter designated by the Label Size Set Command. However, the label-to-label gap is automatically sensed by the transmissive sensor and the paper position is finely adjusted for every piece.
- ④ Transmissive sensor (when using preprinted labels):

Printing takes place according to the parameter designated by the Label Size Set Command. However, the label-to-label gap is automatically sensed by the transmissive sensor and the paper position is finely adjusted for every piece according to the value set by the threshold setting operation (key operation).

⑤ Reflective sensor (when using a manual threshold value)

Printing takes place according to the parameters designated by the Label Size Set Command. However, the black mark provided on the back of the tag paper is automatically sensed by the reflective sensor and the paper position is finely adjusted for every piece, according to the value set by the threshold setting operation (key operation).

(4) Issue mode

[C: Batch mode (Cut interval: 0, Issue count: 3)]

- “Automatic forward feed standby” is set to OFF in the system mode.

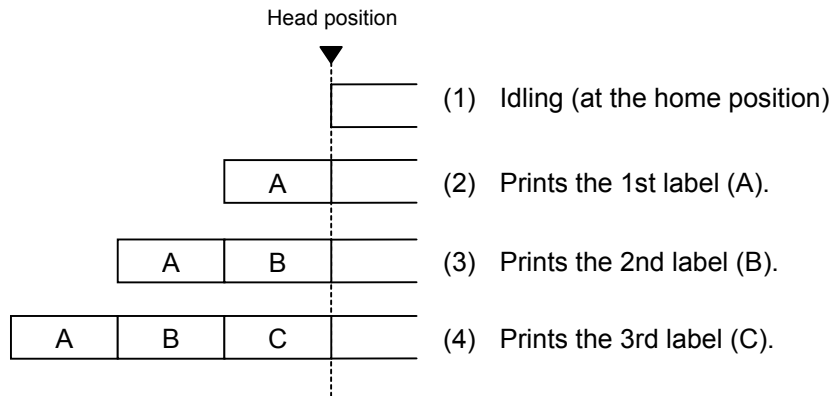

[C: Batch mode (Cut interval: 0, Issue count: 3)]

- “Automatic forward feed standby” is set to ON in the system mode.

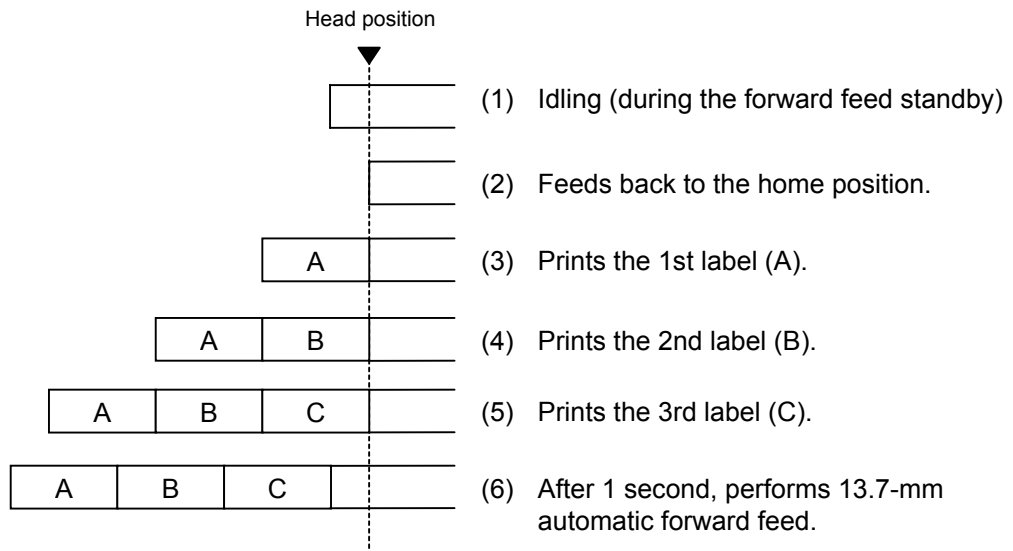

[C: Batch mode (Cut interval: 1, Issue count: 2)]

- “Automatic forward feed standby” is set to OFF in the system mode.
- The swing cutter is used.

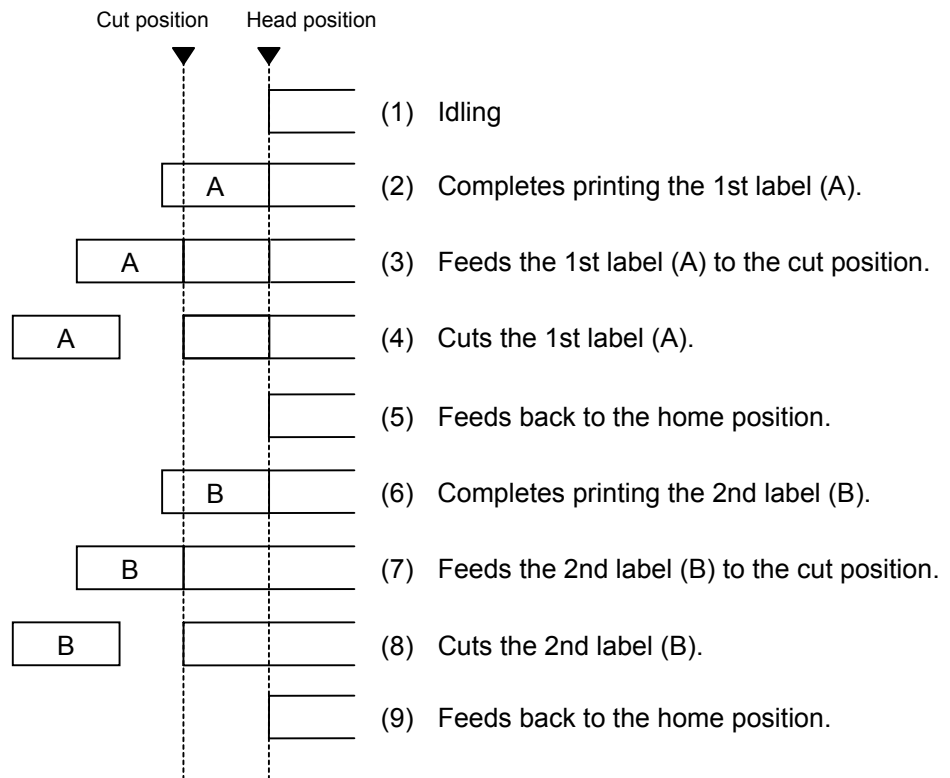

[C: Batch mode (Cut interval: 1, Issue count: 2)]

- “Automatic forward feed standby” is set to ON in the system mode.
- The swing cutter is used.

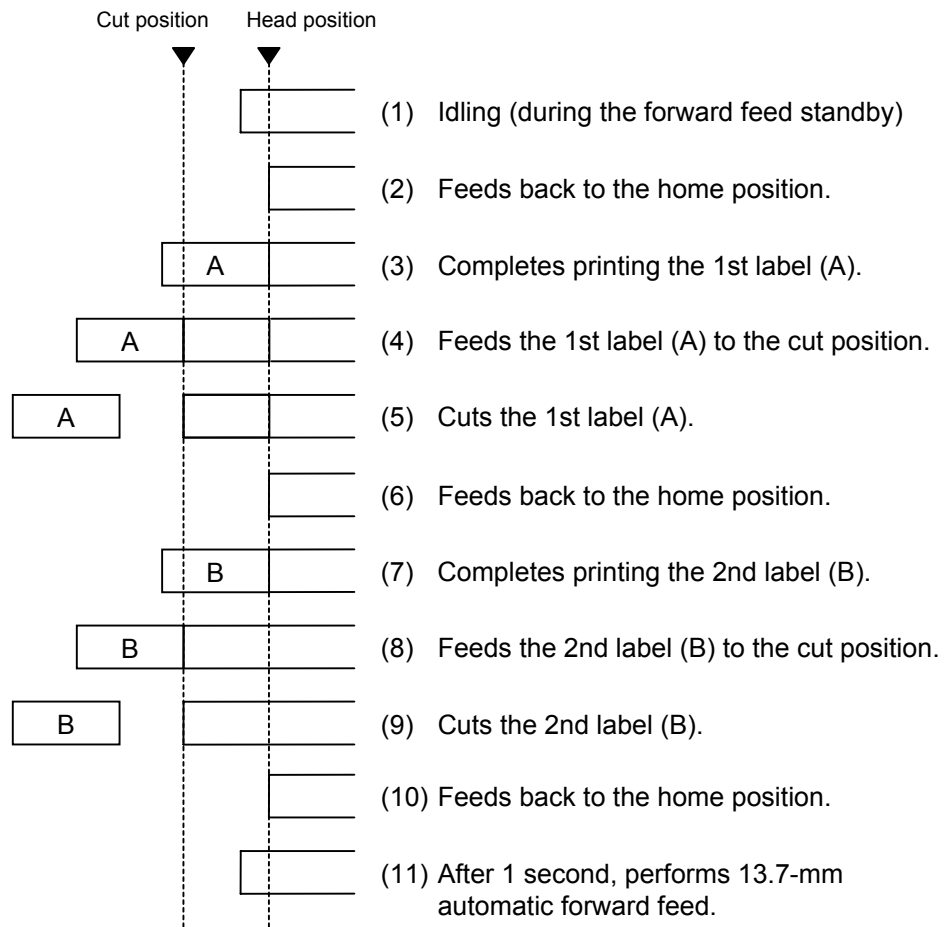

[C: Batch mode (Cut interval: 1, Issue count: 2)]

- “Automatic forward feed standby” is set to OFF in the system mode.
- The rotary cutter is used.

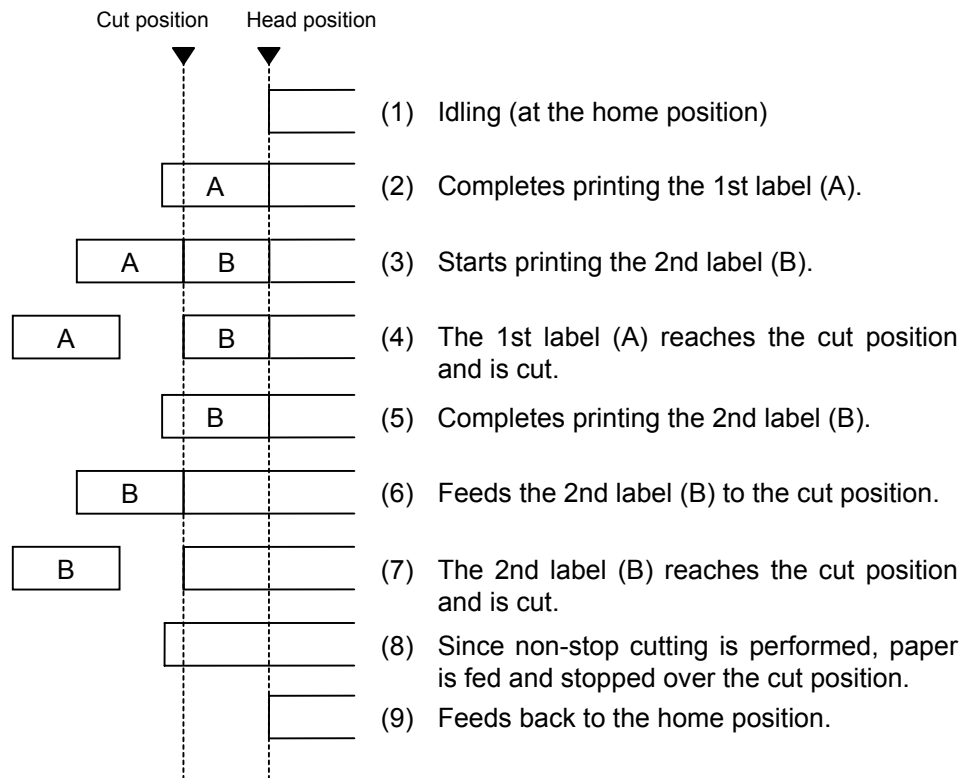

[C: Batch mode (Cut interval: 1, Issue count: 2)]

- “Automatic forward feed standby” is set to ON in the system mode.
- The rotary cutter is used.

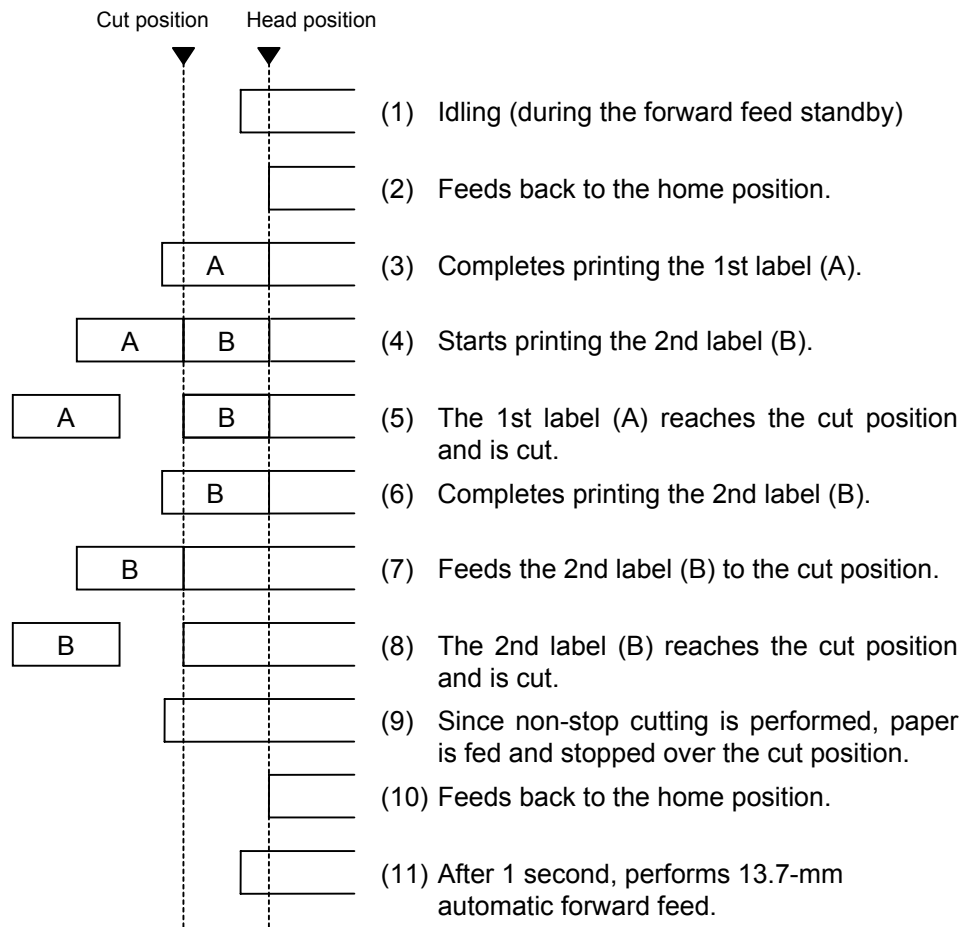

[D: Strip mode (Issue count: 3)]

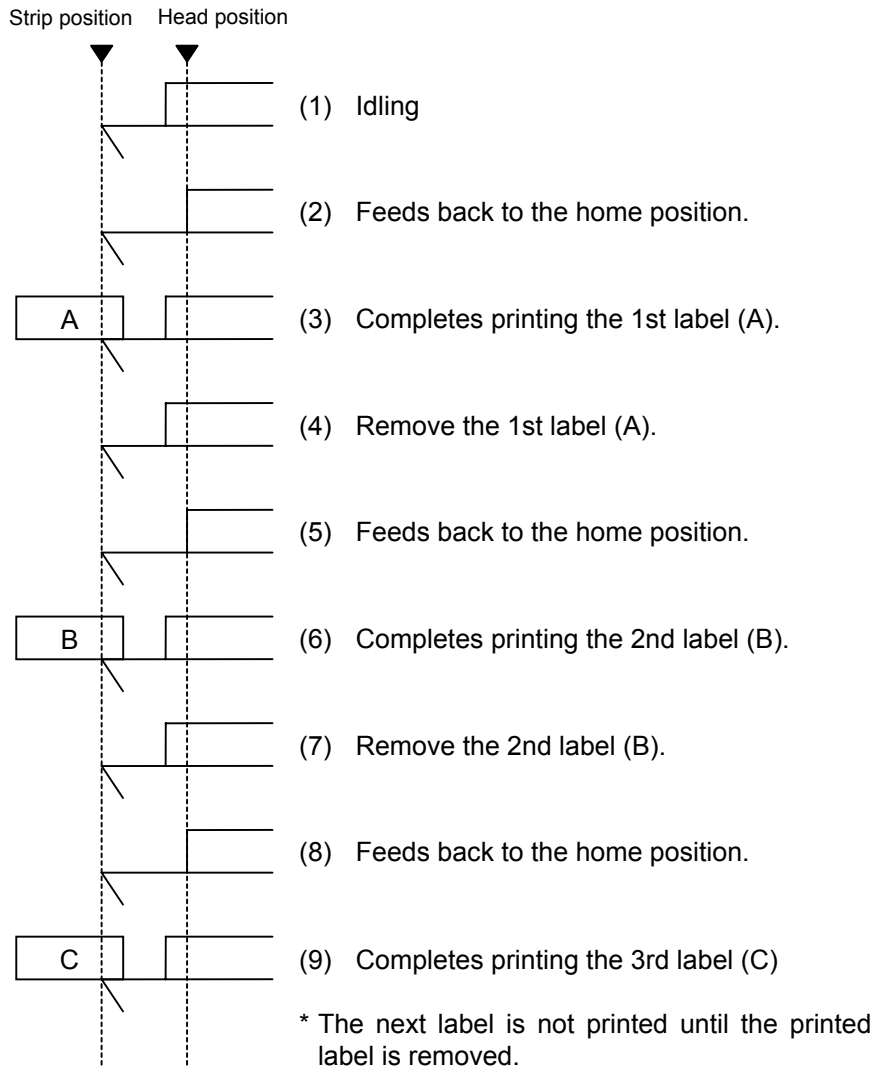

[E: Strip mode (Issue mode: E)]

The expansion I/O is installed:

The strip sensor is ignored. An issue is performed by checking a PAUSE signal generated from the expansion I/O.

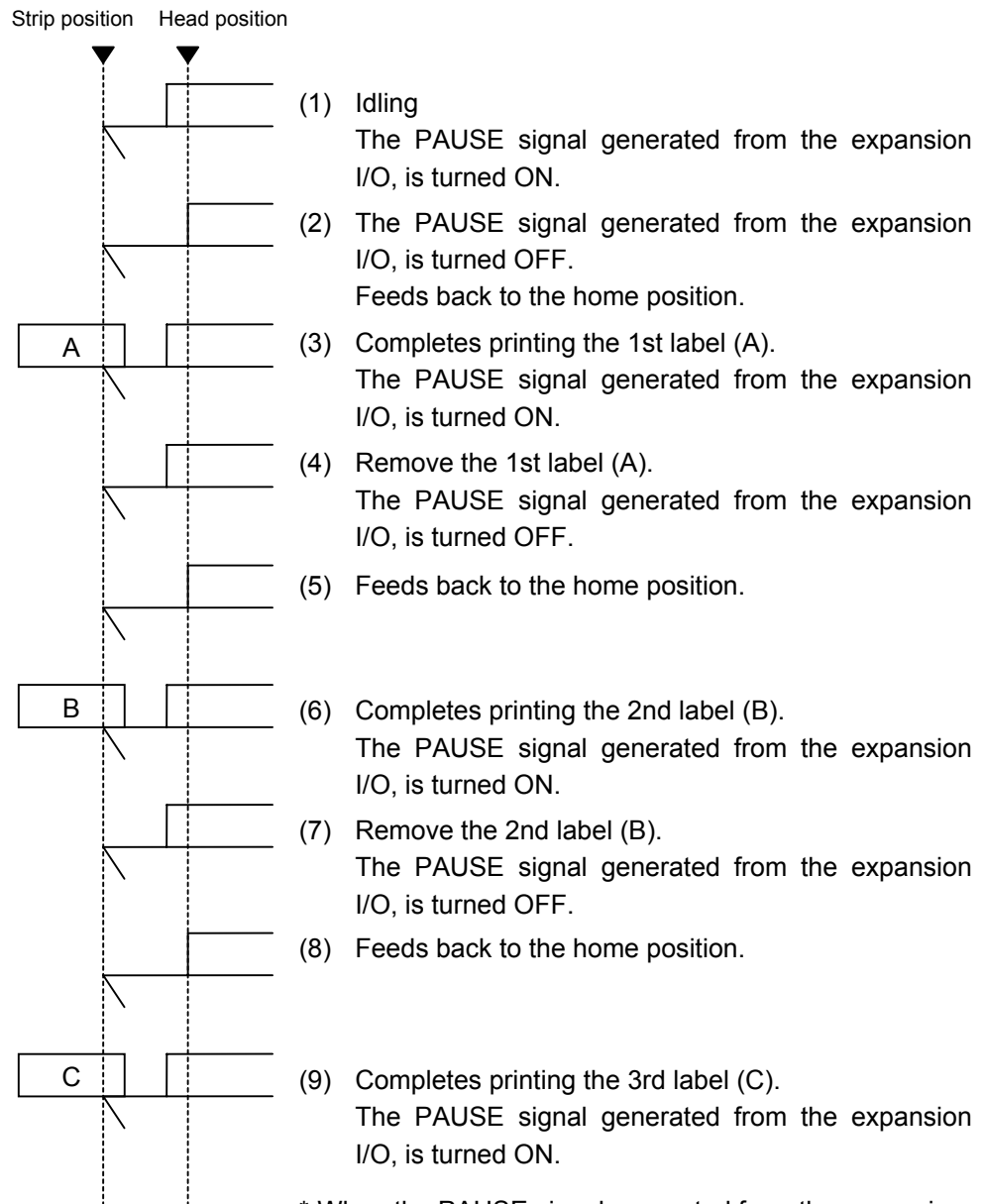

* When the PAUSE signal generated from the expansion I/O is on, a label is not printed.

The expansion I/O is not installed:

The strip sensor is ignored, an issue is performed.

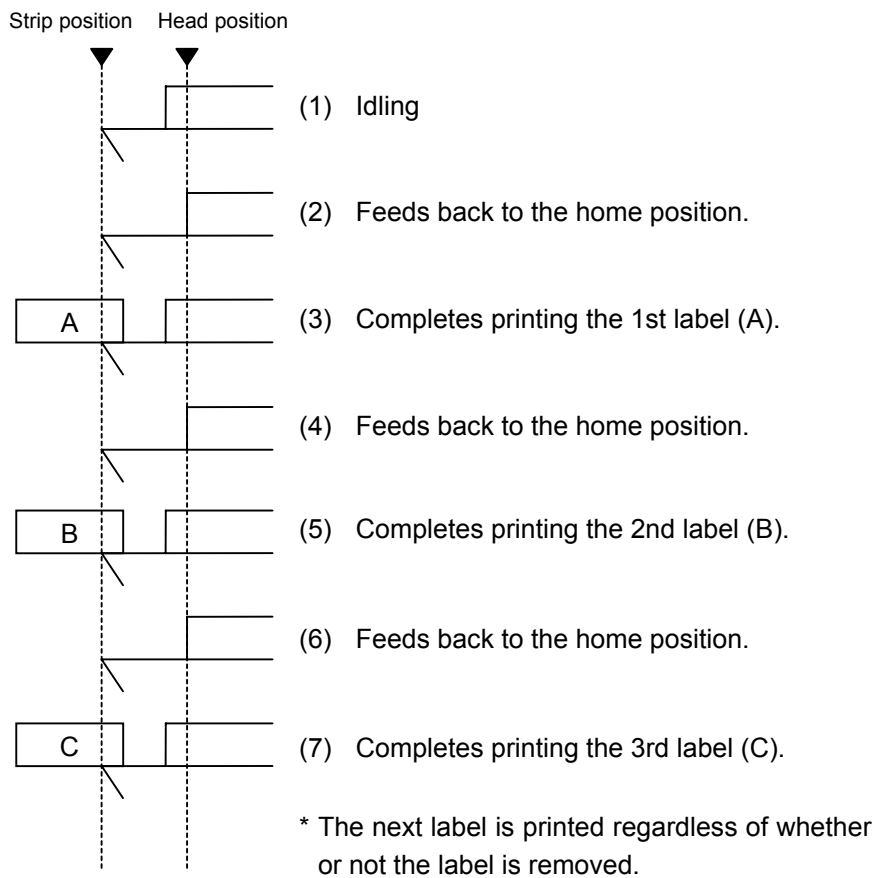

- *1 Issue mode E is different from issue mode D. In issue mode E, a label is issued regardless of whether or not a label to be stripped is placed.
- *2 The peripheral device such as an applicator, must control the PAUSE signal generated from the expansion I/O.
- *3 If the issue count is set to 2 or more to issue labels when the expansion I/O has been installed, the printer issues the specified number of labels while the PAUSE signal generated from the expansion I/O is off.
- *4 If the issue count is set to 2 or more to issue labels when the expansion I/O has not been installed, the specified number of labels is issued.

(5) Issue speed

- Printing takes place at the designated speed.
However, the back feed speed in cut mode and strip mode is 3 ips. This back feed speed can be changed from 3 ips to 2 ips in the system mode.
- For B-SX4T, the print speed “10 ips” is not supported for printing with the rotary cutter. If “10 ips” is specified when the rotary cutter has been installed, the print speed is corrected from 10 ips to 6 ips, regardless of the cut designation.
- The possible issue speed varies according to types and sizes of the paper supply. For details, refer to the Supply Specification.

Parameter \ Model	B-SX4T		B-SX5T
	Rotary cutter not installed	Rotary cutter installed	
1	3 ips	3 ips	3 ips
2			
3			
4			
5	6 ips	6 ips	5 ips
6			
7			
8	10 ips	6 ips	8 ips
9			
A			

(6) With/without ribbon

Without ribbon: Use direct thermal paper.

With ribbon: Use thermal transfer ribbon.

With ribbon saving:

- When there is a non-print area (in the feed direction) of 20 mm or more (30 mm or more at 10 ips for the B-SX4T) in the batch mode, cut mode or strip mode, ribbon saving is performed automatically.
- The minimum print area (in the feed direction) in ribbon saving issue is 8 mm. If the print area is less than 8 mm, printing is performed by automatically assuming the minimum print area of 8 mm.
- Ribbon saving is performed for up to 4 fields (Max: 4 printing fields + 4 ribbon saving fields).
- When the parameter in the Issue Command is set to “Without ribbon saving function”, or the ribbon saving system is set in the system mode so that it is not used, no ribbon saving will take place.

NOTES: 1. To use the ribbon saving function, it is necessary to select the parameter depending on the head lever position. This selection is performed by the parameter settings in the system mode.

Head lever position is “TAG”: Select “RBN SAVE ON(TAG)”

Head lever position is “LABEL”: Select “RBN SAVE ON(LBL)”

Incorrect selection may disable the proper ribbon saving function.

When the head lever position is “TAG” and solenoid type is TYPE1, the thermal head is pulled up with strong power. So, depending on the area in which the ribbon is saved and the number of fields, the head-up solenoid temperature may be raised and the ribbon saving function may not be able to work. Therefore, when the area in which the ribbon is to be saved exceeds the specified value, the ribbon saving length is automatically shortened, as described on the following page, to prevent the temperature from being raised, even if the above conditions are satisfied.

2. If the ribbon saving module has not been installed, when the parameter in the Issue Command is set to “With ribbon saving function”, or the ribbon saving system is set in the system mode so that it is used, the ribbon will sag during printing.

Without ribbon (with head up function): Use direct thermal paper. When there is a non-print area, the print head is raised in the same way with the ribbon save function.

Correction for the ribbon saving area (in case of TAG and solenoid TYPE 1):

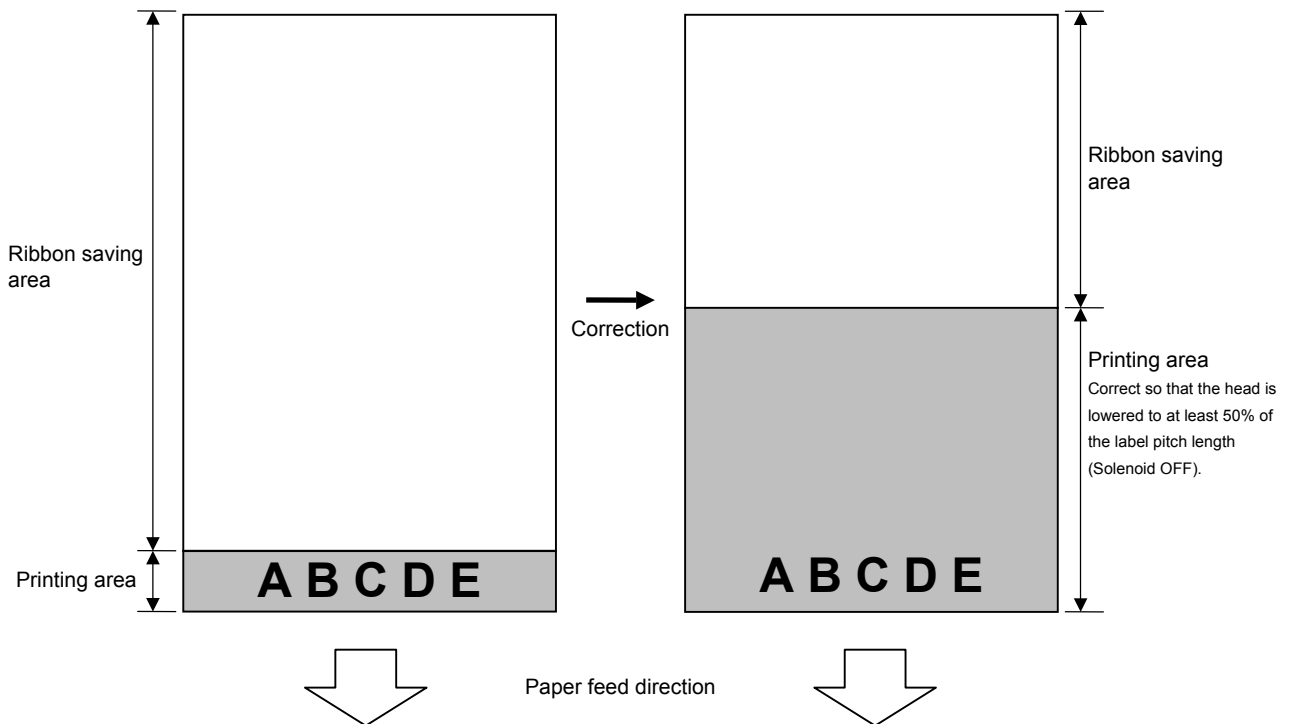
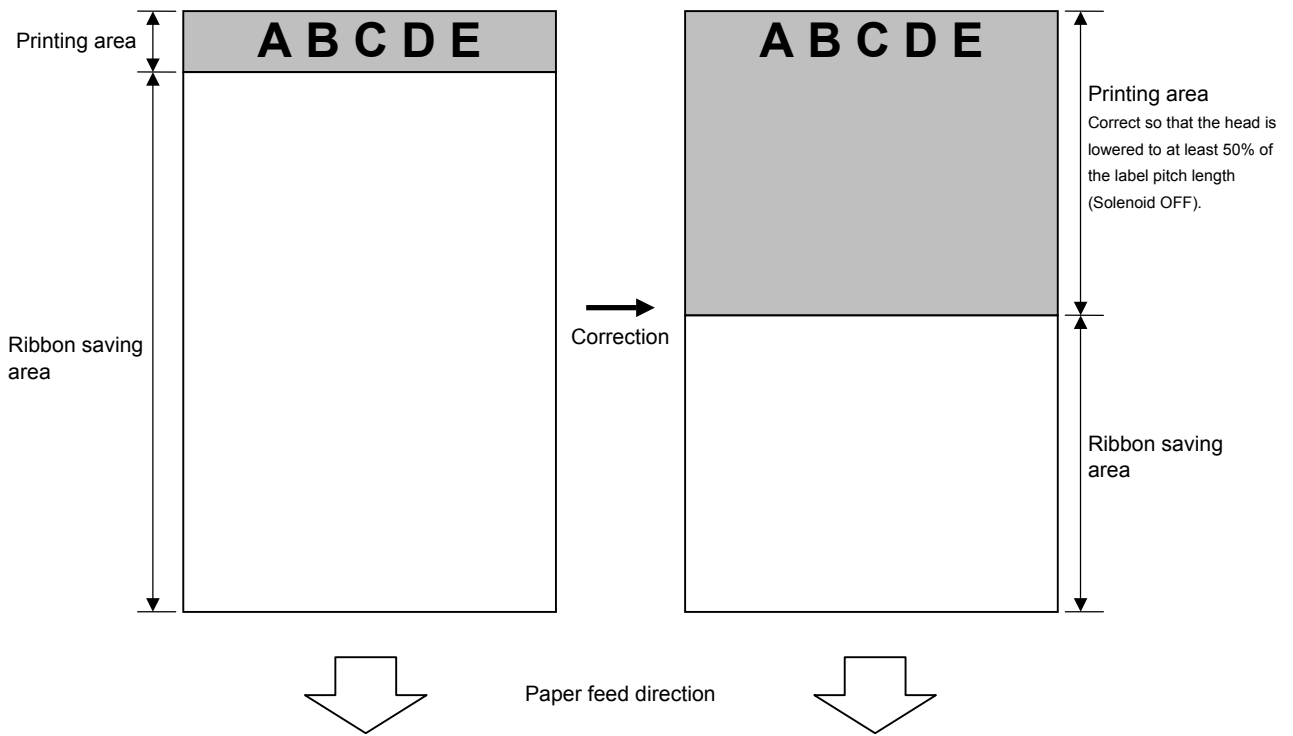

(7) Tag rotation

The origin of coordinates and printing direction vary according to the designation of tag rotation.

① Printing bottom first

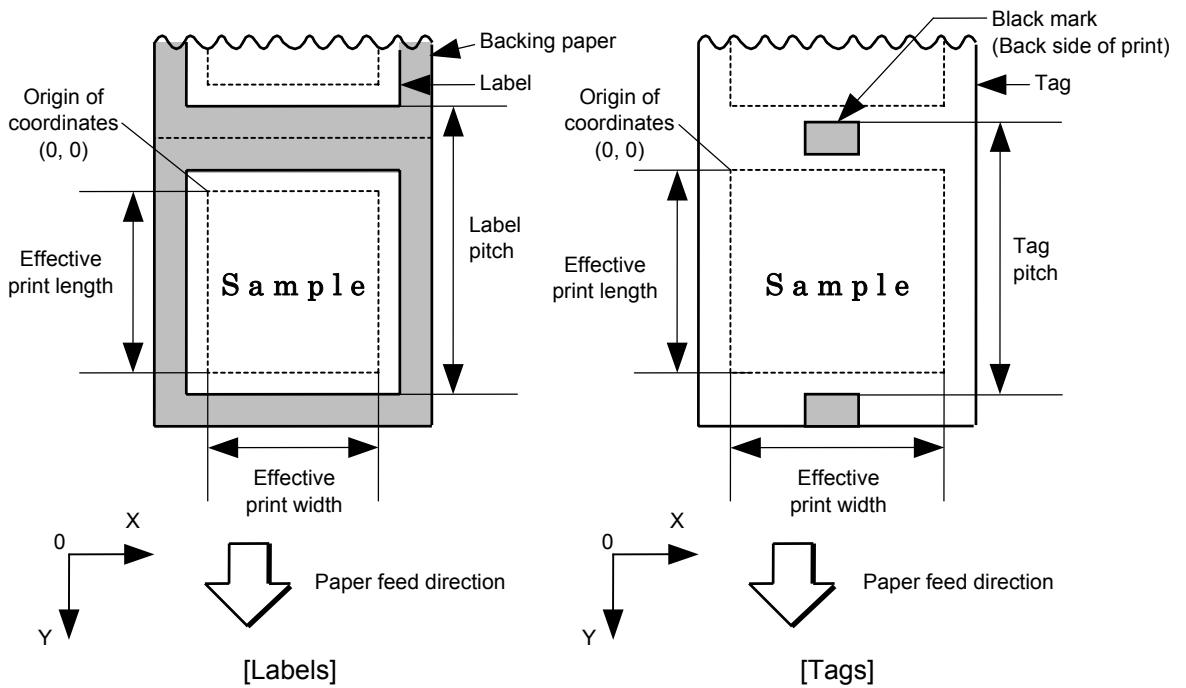

② Printing top first

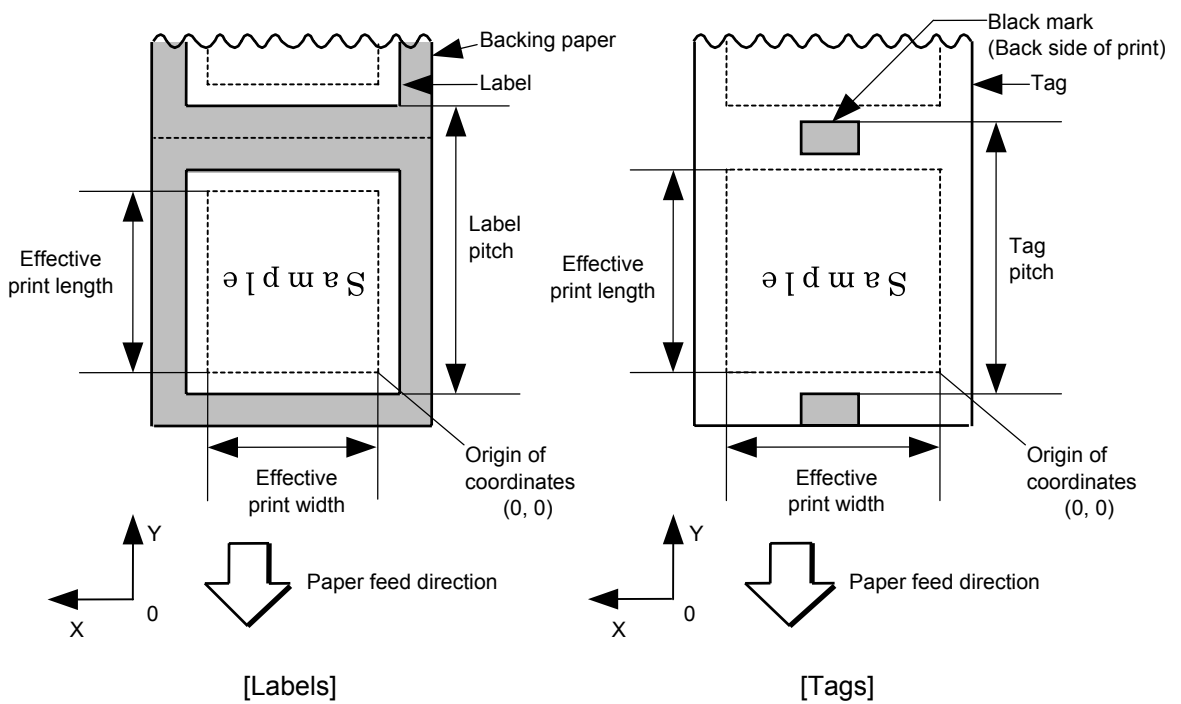

③ Mirror printing bottom first

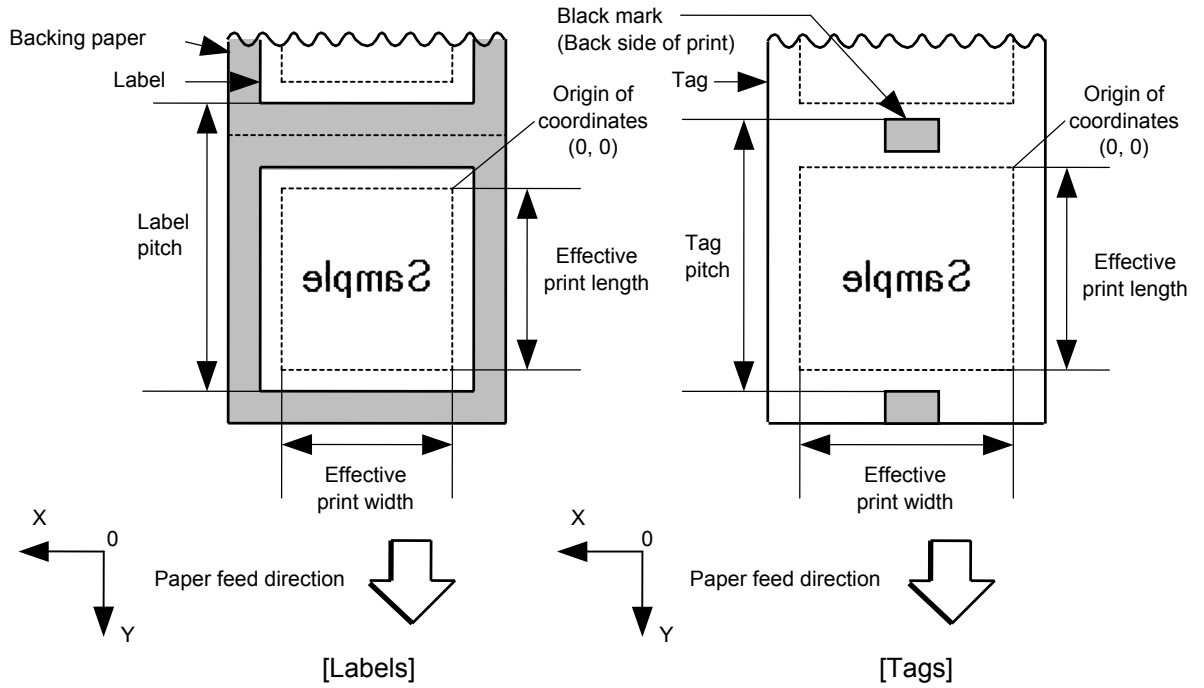

④ Mirror printing top first

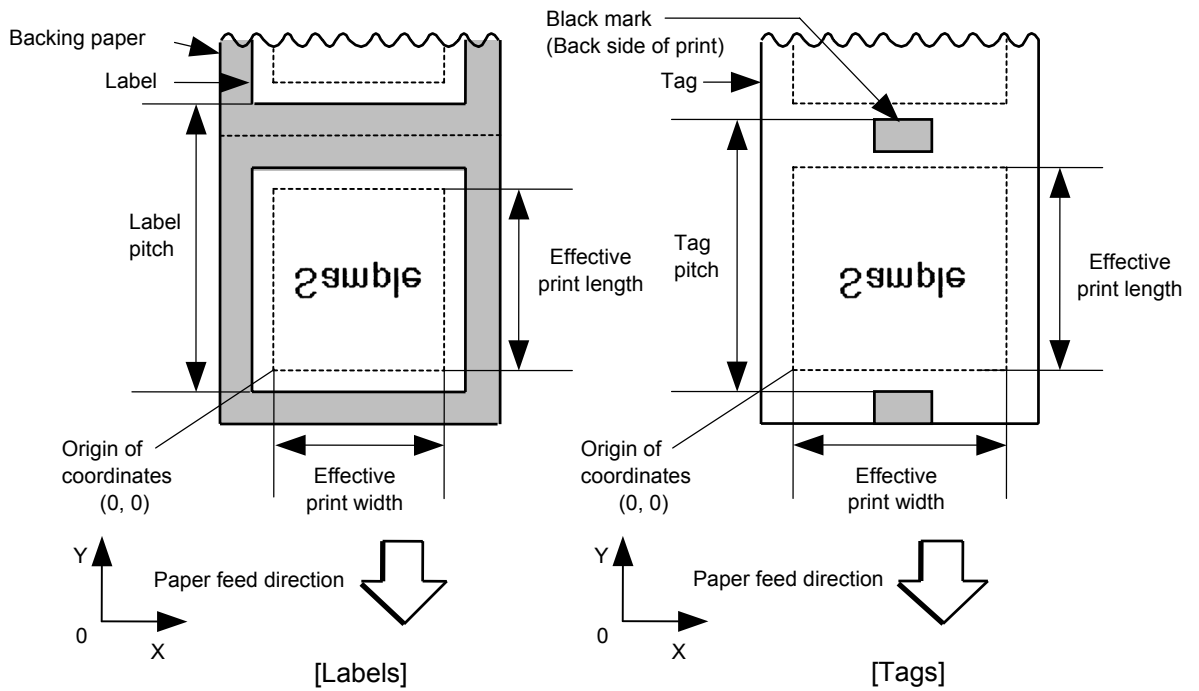

(8) Status response

When the option with status response has been selected, a status response is made at the end of printing or if an error occurs.

In the batch mode and the cut mode, the print end status response is made after printing on the designated number of labels.

In the strip mode, the status response is made after printing one label.

* Do not change the parameter for status response/no status response during printing. Otherwise the status response may not be performed properly.

Examples

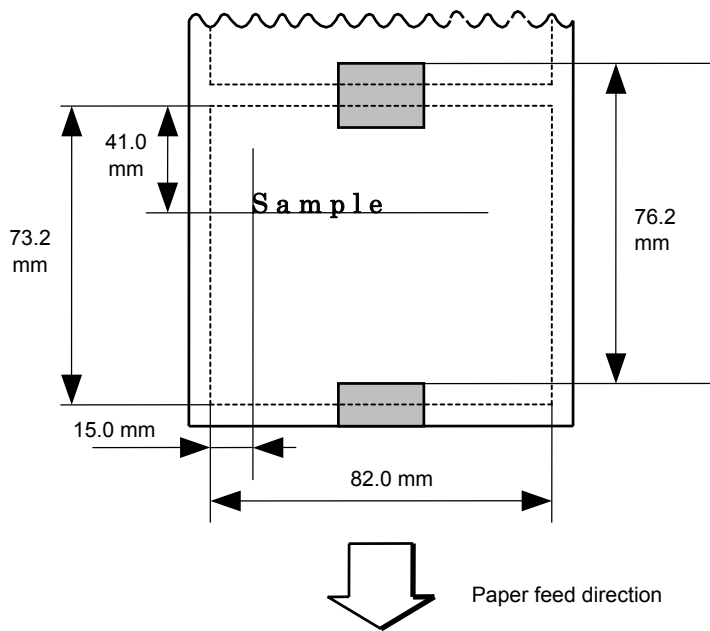

- Issue count: 4 pieces
- Cut interval: 1 piece
- Paper: Tag paper (Reflective sensor used)
- Issue mode: Cut issue
- Issue speed: 8"/sec.
- Ribbon: With
- Status response: On

```
[ESC] D0762, 0820, 0732 [LF] [NUL]
[ESC] T11C30 [LF] [NUL]
[ESC] C [LF] [NUL]
[ESC] PC001; 0150, 0410, 1, 1, A, 00, B [LF] [NUL]
[ESC] RC001; Sample [LF] [NUL]
[ESC] XS; I, 0004, 0011C8201 [LF] [NUL]
```

Notes

- ⊙ Explanation of processes involved to stop the label at the home position after the head-open state is detected:

When the gap between labels (black mark) is found after the head open state is detected, the value to stop at the home position of each label between the head and the sensor is set again.

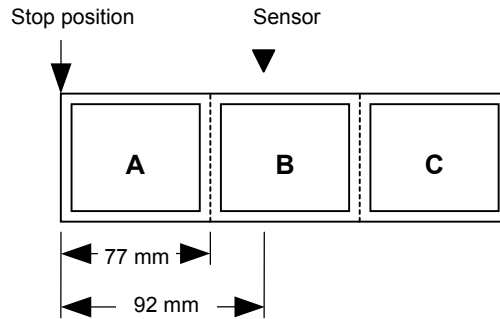

- The paper is moved in the above state.

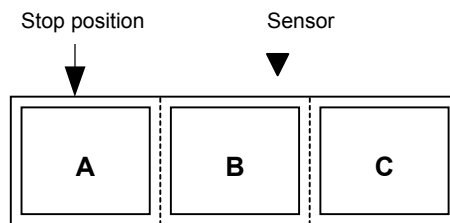

- Stop position after feeding one label

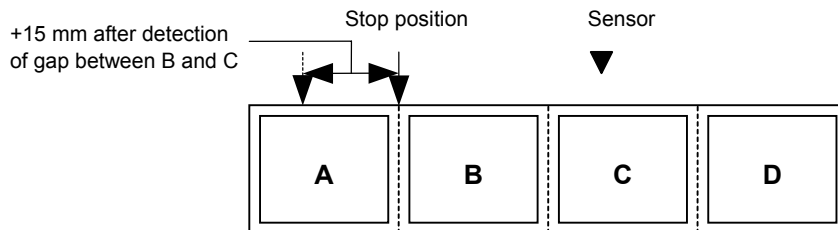

* However, an error will result when feed jam conditions are met.

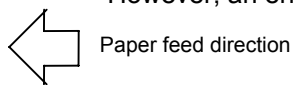

6.3.15 FEED COMMAND

[ESC] T

Function	Feeds the paper.
Format	[ESC] Tabcde [LF] [NUL]
Term	<p>a: Type of sensor 0: No sensor 1: Reflective sensor 2: Transmissive sensor (when using normal labels) 3: Transmissive sensor (when using preprinted labels) 4: Reflective sensor (when using a manual threshold value)</p> <p>b: Selects cut or non-cut 0: Non-cut 1: Cut</p> <p>c: Feed mode C: Batch mode (Cut and feed when "1 (Cut)" is selected for parameter b.) D: Strip mode (with back feed) E: Strip mode (with back feed, the strip sensor is ignored, the applicator supports this mode.)</p> <p>d: Feed speed B-SX4T: B-SX5T: 3: 3 ips 3: 3 ips 6: 6 ips 5: 5 ips A: 10 ips 8: 8 ips</p> <p>e: With/without ribbon 0: Without ribbon 1: With ribbon (with ribbon saving function) 2: With ribbon (without ribbon saving function)</p>

Explanation	<p>(1) Type of sensor</p> <p>① No sensor: Feeding takes place according to the parameter designated by the Label Size Set Command.</p> <p>② Reflective sensor: Feeding takes place according to the parameter designated by the Label Size Set Command. However, the black mark provided on the back side of the tag paper is automatically sensed by the reflective sensor and the stop position is finely adjusted.</p> <p>③ Transmissive sensor (when using normal labels): Feeding takes place according to the parameter designated by the Label Size Set Command. However, the label-to-label gap is automatically sensed by the transmissive sensor and the stop position is finely adjusted.</p>
-------------	--

④ Transmissive sensor (when using preprinted labels):

Feeding takes place according to the parameter designated by the Label Size Set Command. However, the label-to-label gap is automatically sensed by the transmissive sensor and the stop position is finely adjusted according to the value set by the threshold set operation (key operation).

⑤ Reflective sensor (when using a manual threshold value)

Feeding takes place according to the parameters designated by the Label Size Set Command. However, the black mark provided on the back of the tag paper is automatically sensed by the reflective sensor and the paper position is finely adjusted for every piece, according to the value set by the threshold set operation (key operation).

(2) Cut/non-cut

This option is valid in the batch feed mode only. (Non-cut is selected in the strip mode.) If no subsequent command is received from the PC for 1 second when the automatic forward feed is set to ON, the printer automatically performs an approximately 13.7-mm forward feed.

When the Feed Command is received in the forward feed standby state, the printer performs a reverse feed to the original position.

* For notes, refer to the section regarding the Issue Command.

For cutting the label having label pitch of 38 mm or less by the swing cutter, refer to the section regarding the Position Fine Adjust Command.

(3) Feed mode

[C: Batch (Non-cut)]

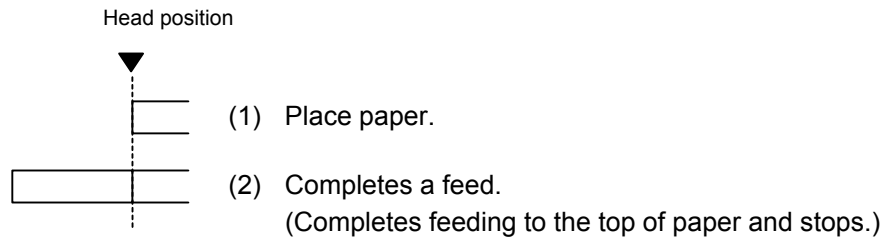

[C: Batch (Cut)]

- "Automatic forward feed standby" is set to OFF in the system mode.
- The swing cutter is used.

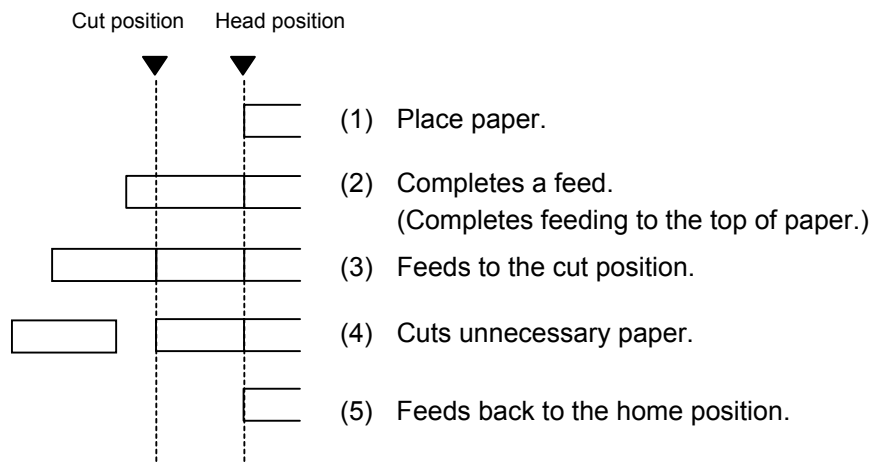

[C: Batch (Cut)]

- “Automatic forward feed standby” is set to ON in the system mode.
- The swing cutter is used.

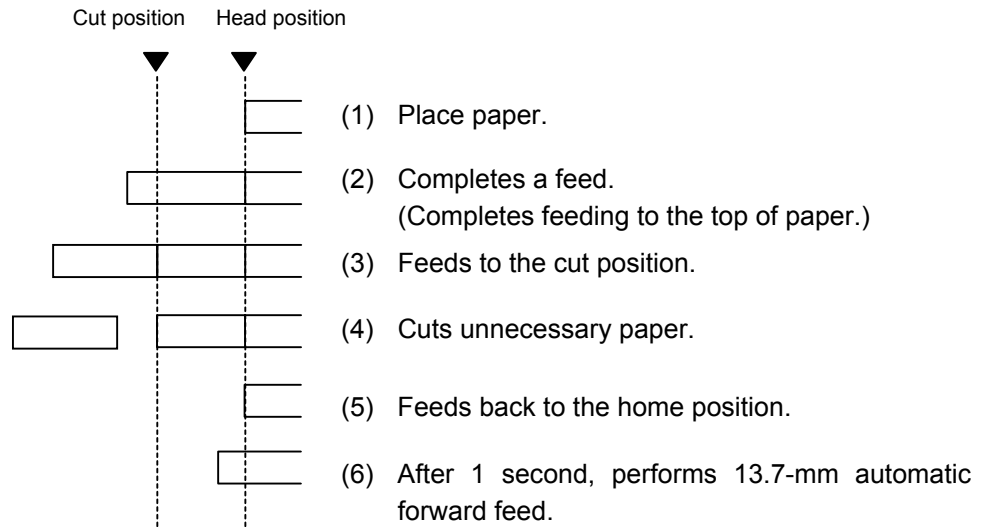

[C: Batch (Cut)]

- “Automatic forward feed standby” is set to OFF in the system mode.
- The rotary cutter is used.

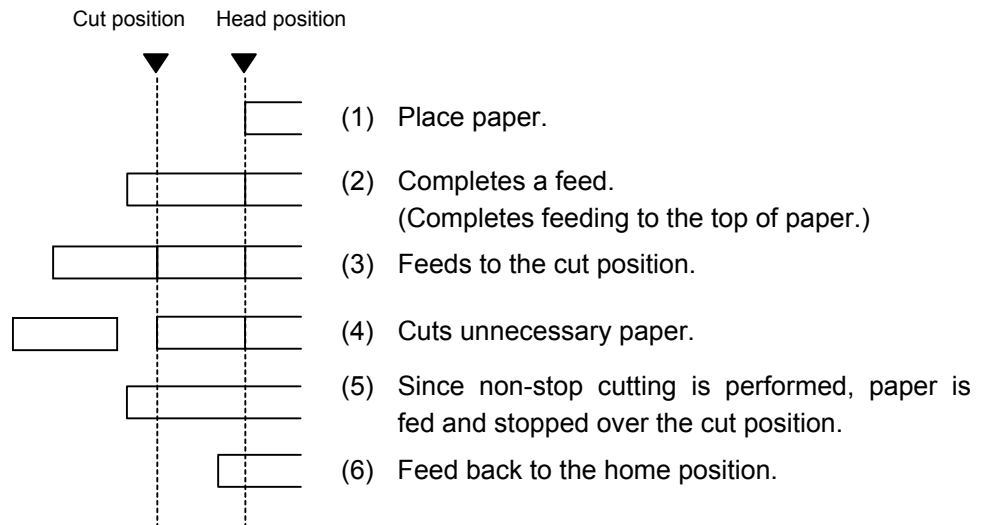

[C: Batch (Cut)]

- “Automatic forward feed standby” is set to ON in the system mode.
- The rotary cutter is used.

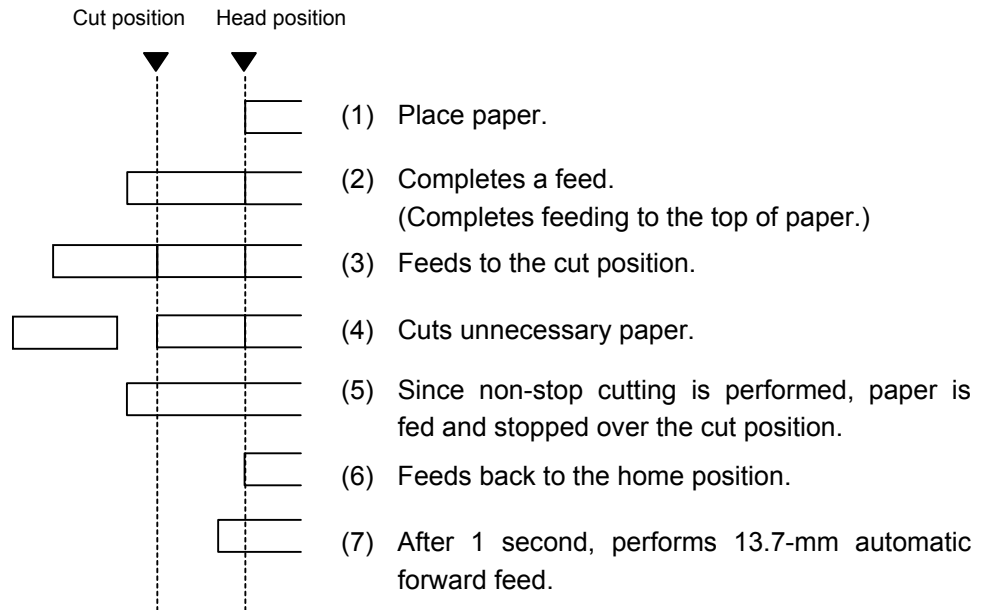

[D: Strip]

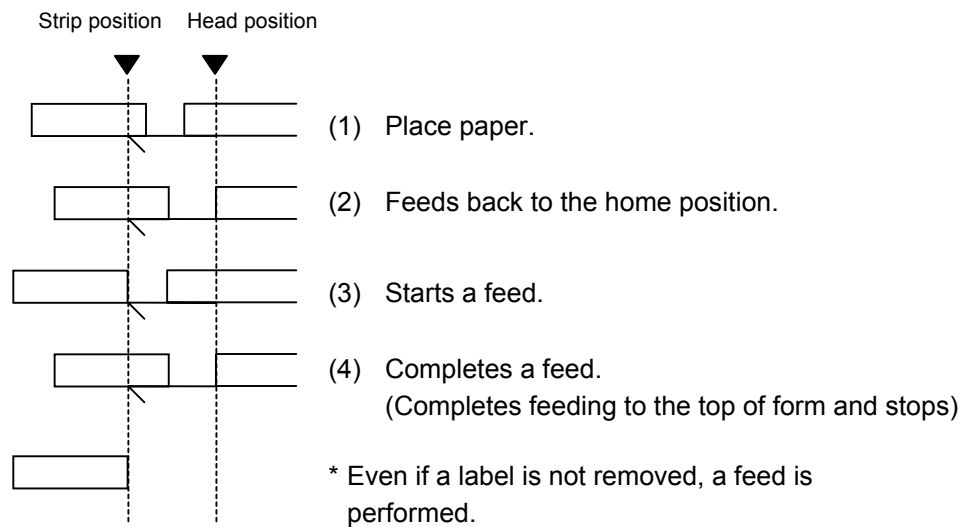

[E: Strip (Feed mode: E)]

Expansion I/O is installed:

The strip sensor is ignored. A feed is performed by checking a PAUSE signal generated from the expansion I/O.

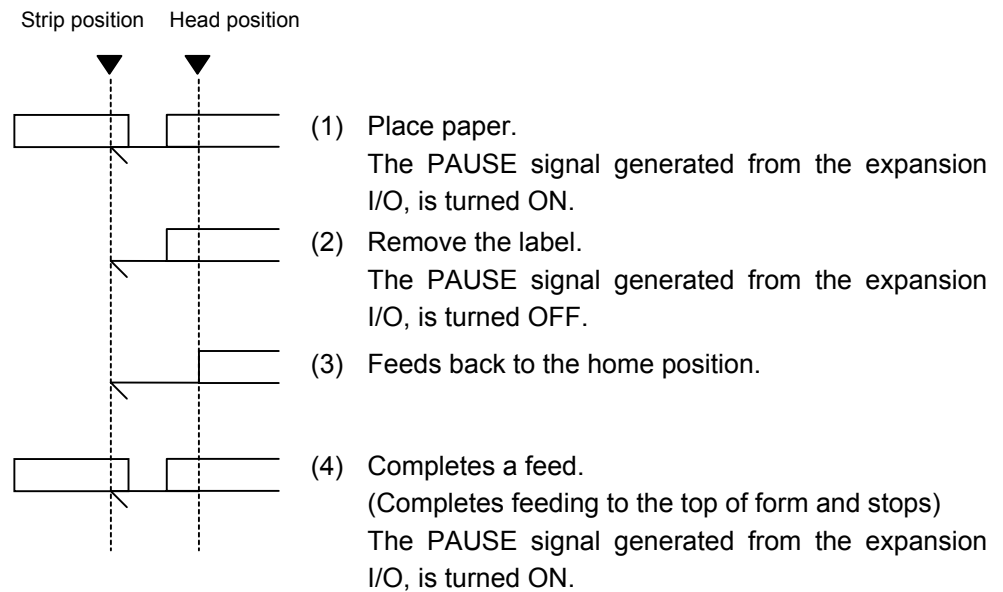

Expansion I/O is not installed:

The strip sensor is ignored. A feed is performed.

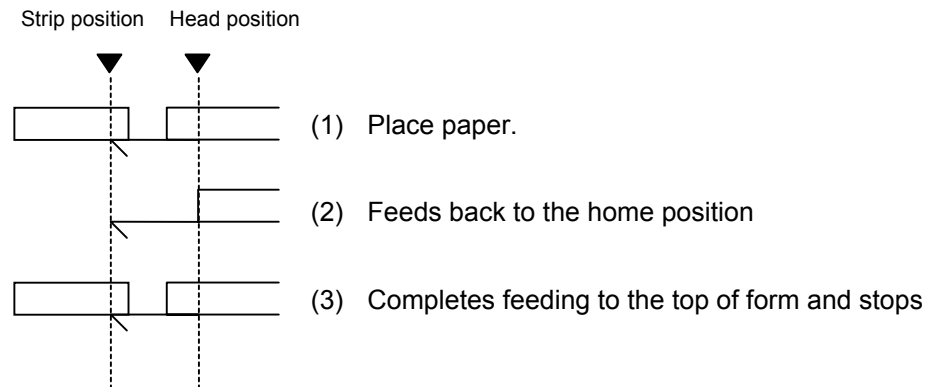

*1 Feed mode E is different from feed mode D. In feed mode E, a label is fed, regardless of whether or not a label to be stripped is placed.

*2: The peripheral device such as an applicator, must control the PAUSE signal generated from the expansion I/O.

(4) Feed speed

- A feed is performed at the designated speed.
However, the back feed speed in the cut mode or the strip mode is 3 ips. This back feed speed can be changed from 3 ips to 2 ips in the system mode.
- For B-SX4T, the print speed “10 ips” is not supported for printing with the rotary cutter. If “10 ips” is specified when the rotary cutter has been installed, the print speed is corrected from 10 ips to 6 ips, regardless of the cut designation.
- The possible issue speed varies according to types and sizes of the paper supply. For details, refer to the Supply Specification.

Model Parameter	B-SX4T		B-SX5T
	Rotary cutter not installed	Rotary cutter installed	
1	3 ips	3 ips	3 ips
2			
3			
4			
5	6 ips	6 ips	5 ips
6			
7			
8	10 ips		8 ips
9			
A			

(5) With/without ribbon

Without ribbon: The ribbon motor is not operated at feed.

With ribbon: The ribbon motor is operated at feed.

With ribbon saving: When the use of the ribbon saving system is set to ON (used) in the system mode, ribbon saving will be performed automatically.

When “without ribbon saving” is selected, or the use of the ribbon saving system is set to OFF (not used) in the system mode, ribbon saving will not be performed.

Notes

- (1) If a change of label size or type of sensor, feed fine adjustment, cut position fine adjustment (or strip position fine adjustment) or back feed fine adjustment is made, one label must be fed to adjust the first print position prior to printing.
- (2) The parameter of the Feed Command is protected in memory (even if the power is turned off).
- (3) When “status response made” is selected in the Issue Command parameter setting, a status response is made after the end of feed or when an error occurs.
- (4) For explanation about the process to stop the label at the home position, refer to the section regarding the Issue Command.
- (5) If no subsequent command is received from the PC for 1 second after the last label has been fed, the printer automatically performs an approximately 13.7-mm forward feed when “Automatic forward feed standby” is set to ON in the system mode. When the Feed Command is received during the forward feed standby, the printer feeds the label in reverse to the original position, and then ejects it.
* For notes, refer to the section regarding the Issue Command.

Examples

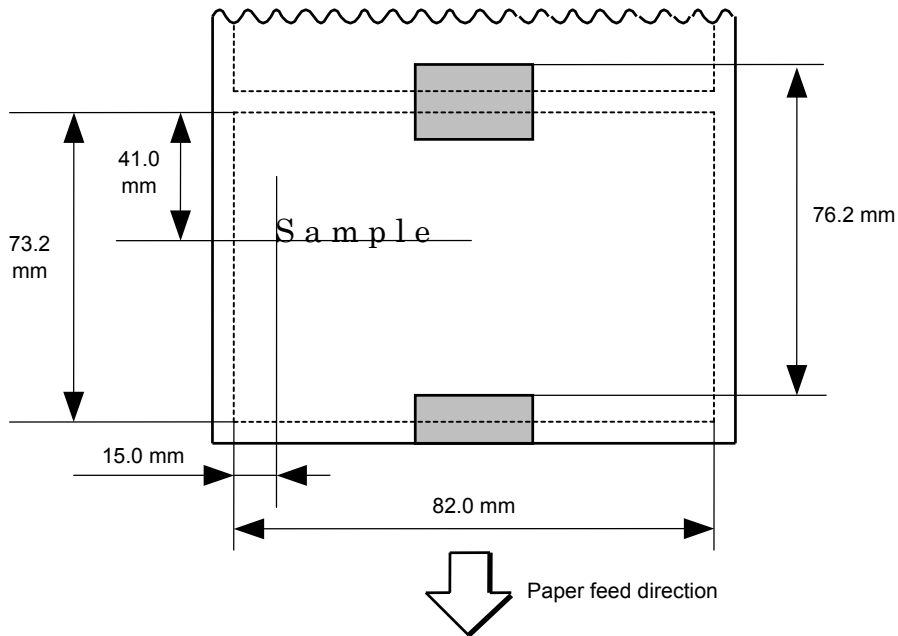

```
[ESC] D0762, 0820, 0732 [LF] [NUL]  
[ESC] AX; +010, +000, +10 [LF] [NUL]  
[ESC] T11C30 [LF] [NUL]  
[ESC] C [LF] [NUL]  
[ESC] PC001; 0150, 0410, 1, 1, A, 00, B [LF] [NUL]  
[ESC] RC001; Sample [LF] [NUL]  
[ESC] XS; I, 0004, 0011C3001 [LF] [NUL]
```

6.3.16 EJECT COMMAND

[ESC] IB

Function Ejects (cuts) the label presently remaining between the head and the cutter and returns to the original position.

Format [ESC] IB [LF] [NUL]

Notes If no subsequent command is received from the PC for 1 second after ejection, the printer automatically performs an approximately 13.7-mm forward feed when “Automatic forward feed standby” is set to ON in the system mode.
When the Eject Command is received in the forward feed standby state, the printer feeds the label in reverse to the original position, and then ejects it.

* For notes, refer to the section regarding the Issue Command.

Examples • The swing cutter is used:

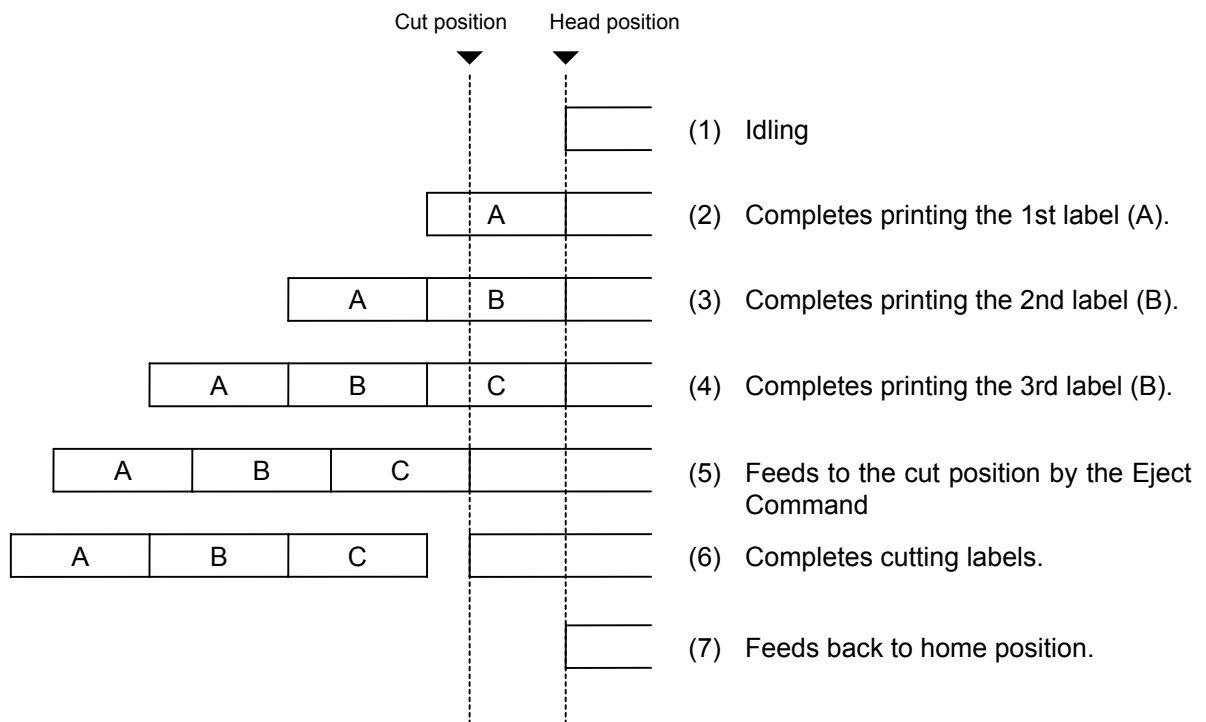

- The rotary cutter is used:

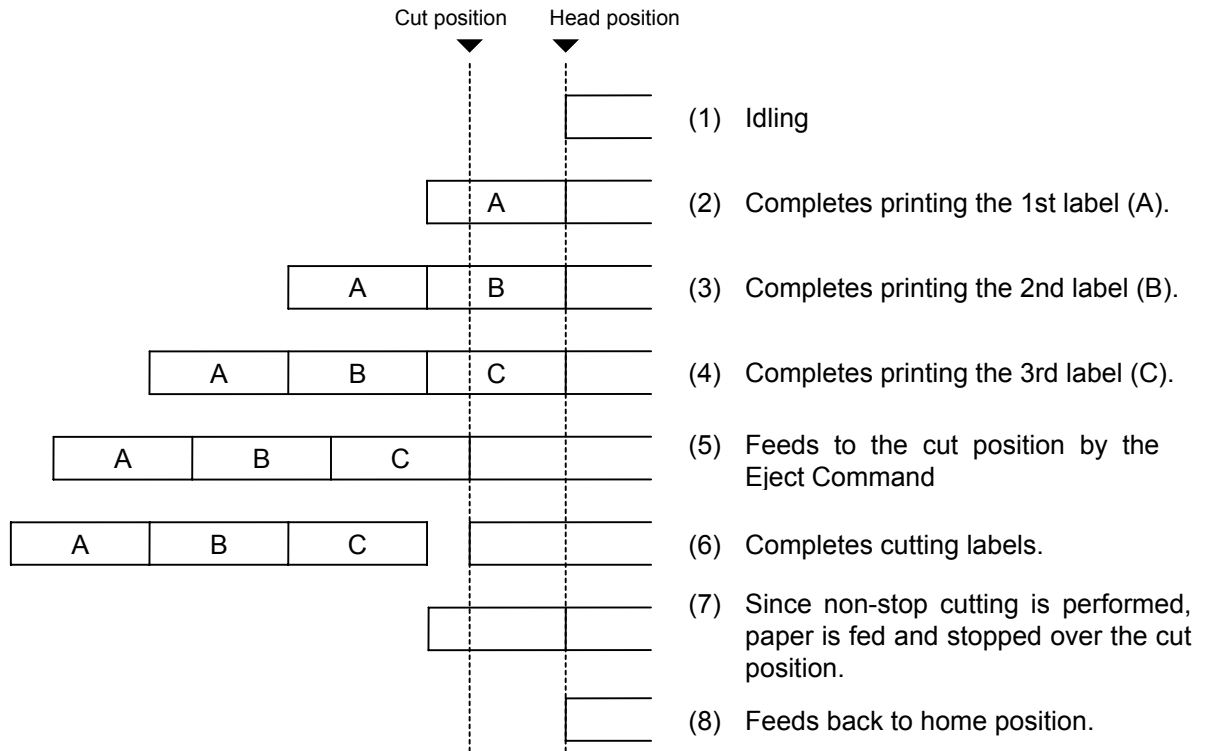

```
[ESC] C [LF] [NUL]
[ESC] PC001; 0200, 0125, 1, 1, A, 00, B [LF] [NUL]
[ESC] RC001; A [LF] [NUL]
[ESC] XS; I, 0001, 0001C3001 [LF] [NUL]
[ESC] RC001; B [LF] [NUL]
[ESC] XS; I, 0001, 0001C3001 [LF] [NUL]
[ESC] RC001; C [LF] [NUL]
[ESC] XS; I, 0001, 0001C3001 [LF] [NUL]
[ESC] IB [LF] [NUL]
```

6.3.17 FORWARD/REVERSE FEED COMMAND

[ESC] U1, [ESC] U2

Function	<p>After printing or feeding the paper, feeds the paper to the position at which a label can be cut manually.</p> <p>When issuing the next label, feeds the paper back to the first print position.</p>
Format	<p>Forward Feed [ESC] U1; aaaa (, b) [LF] [NUL]</p> <p>Reverse Feed [ESC] U2; aaaa (, b) [LF] [NUL]</p>
Term	<p>aaaa: Feed value by which the paper is fed forward or backward. 0030 to 2000 (in 0.1 mm units)</p> <p>b: Head up function (Omissible. When omitted, the head up function is not performed.) 0: Head up function is not performed. 1: Head up function is performed.</p>
Notes	<ol style="list-style-type: none">(1) When the [FEED] key is pressed on the printer, one label is fed, and then fed by the forward feed value automatically if the Forward Feed Command has already been transmitted.(2) The Forward/Reverse Feed Command is protected in memory (even if the power is turned off).(3) The Forward/Reverse Feed Command is ignored in the strip mode and the cut issue mode.(4) The Forward/Reverse Feed Command feeds the label without ribbon saving even if the ribbon saving issue is designated.(5) The forward feed is performed at the speed designated by the Issue Command or Feed Command. The reverse feed is performed at 3 ips. This reverse feed speed can be changed from 3 ips to 2 ips in the system mode.(6) There may be cases, where a specified length of a reverse feed is not performed, depending on the print conditions. In issues where any paper sensor is used, if the label pitch length is almost the same as the distance between the thermal print head and the paper sensors (75.5 mm), a label/tag may not be returned to the first print position, even when the same value is specified for both a forward feed and a reverse feed. It may result in an error. In such cases, to prevent an error from occurring, the reverse feed length should be set to a value larger than the forward feed value.

Examples

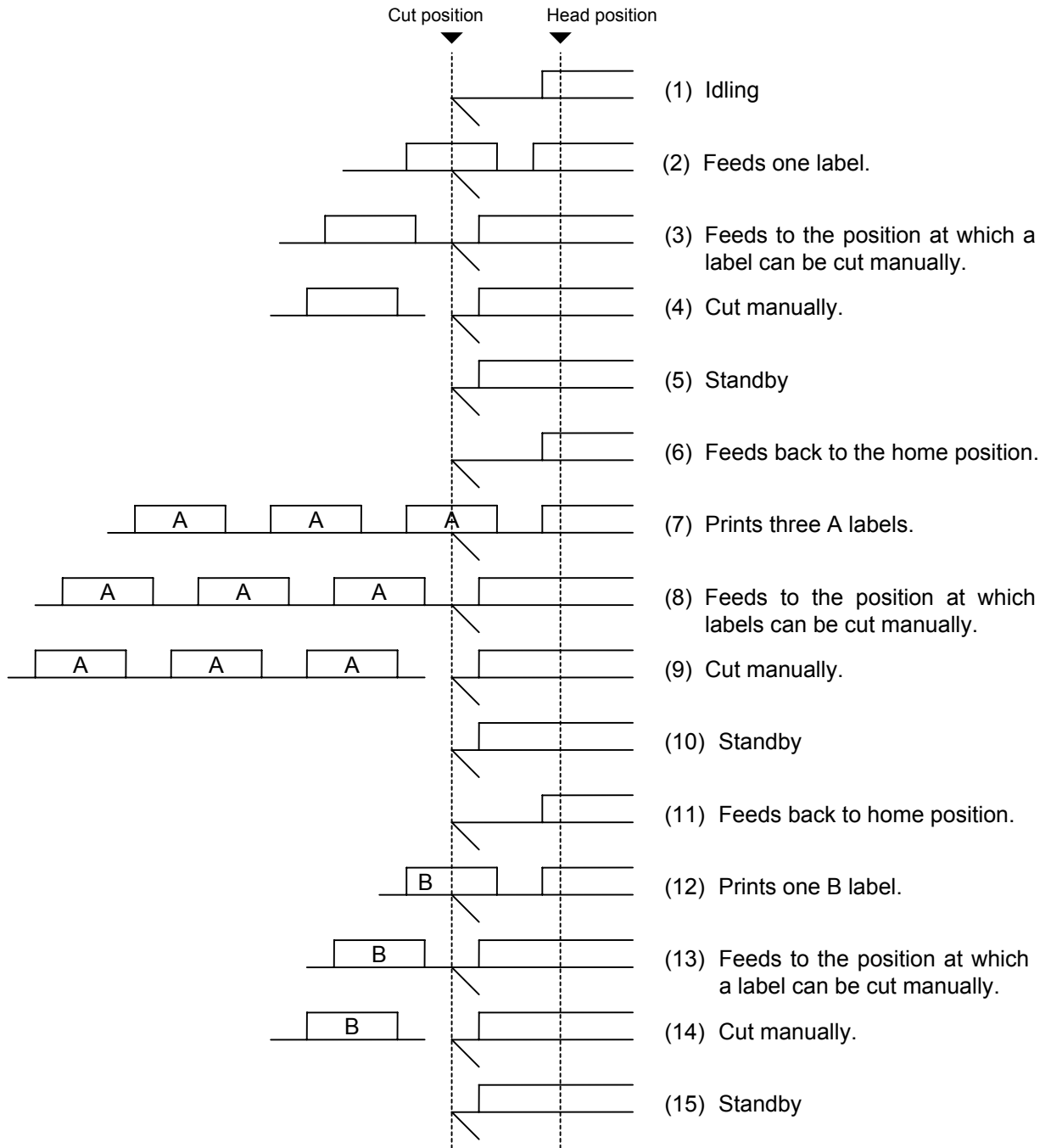

```
[ESC] T20C30 [LF] [NUL]
[ESC] U1; 0120 [LF] [NUL]
Cut manually.
[ESC] U2; 0120 [LF] [NUL]
[ESC] RC001; A [LF] [NUL]
[ESC] XS; I, 0003, 0002C3001 [LF] [NUL]
[ESC] U1; 0120 [LF] [NUL]
Cut manually.
[ESC] U2; 0120 [LF] [NUL]
[ESC] RC001; B [LF] [NUL]
[ESC] XS; I, 0001, 0002C3001 [LF] [NUL]
[ESC] U1; 0120 [LF] [NUL]
```

6.3.18 STORAGE AREA ALLOCATE COMMAND

[ESC] XF

Function	Allocates the storage area in flash ROM on the CPU board.
Format	[ESC] XF; aa, bb, cc [LF] [NUL]
Term	aa: Size of the TrueType font storage area 00 to 14 (0 KB to 896 KB) (in units of 64 KB) bb: Size of bit map writable character storage area 00 to 14 (0 KB to 896 KB) (in units of 64 KB) cc: Size of BASIC file storage area 00 to 14 (0 KB to 896 KB) (in units of 64 KB) AA: The current BASIC file storage area and contents are retained.
Explanation	<p>(1) The storage area in flash ROM has a total capacity of 896 KB. In case that the size of BASIC file storage area is set in a range of “00” to “14”:</p> <p>(2) When this command is received, the entire area in flash ROM on the CPU board is cleared.</p> <p>(3) If this command is not sent, the storage area in flash ROM on the CPU board cannot be used.</p> <p>(4) The storage areas are allocated in the following order of precedence – the TrueType font storage area, the bit map writable character storage area, and the BASIC file storage area. After these storage areas are allocated, the remaining area is used for the PC save area.</p> <p>(5) If the sum of the TrueType font storage area, the bit map writable character storage area, and the BASIC file storage area, specified by this command, is 896 KB, the TrueType font storage area, the bit map writable character storage area, and the BASIC file storage area are allocated as specified, respectively. In this case, however, there is no PC save area.</p> <p>(6) If the sum of TrueType font storage area, the bit map writable character storage area, and the BASIC file storage area, specified by this command, exceeds 896 KB, the TrueType font storage area is allocated as specified with the highest priority. Then, the remaining area is allocated to the bit map writable character storage area. If there is still remaining area after the TrueType font storage area and the bit map writable character storage area are allocated, it is used for the BASIC file storage area. There is no PC save area.</p> <p>(7) When “00” (0 KB) is specified for each of the TrueType font storage area, the bit map writable character storage area, and the BASIC file storage area, the storage area is not allocated.</p> <p>(8) When “14” (896 KB) is specified for any of the TrueType font storage area, the bit map writable character storage area, and the BASIC file storage area, the entire storage areas are occupied by that area. For example, if “14” is specified for the TrueType Font storage area, the entire storage areas are used for the TrueType Font storage area. The bit map writable character storage area, the BASIC file storage area, and the PC save area cannot be allocated.</p>

In case that the size of BASIC file storage area is set to "AA":

- (9) When this command is received, the BASIC file storage area is reserved and the other areas in flash ROM on the CPU board are cleared.
- (10) If this command is not sent, the storage area in flash ROM on the CPU board cannot be used.
If "AA" is set for the size of the BASIC file storage area with the BASIC file storage area being unallocated, the BASIC file storage area remains unallocated.
- (11) The storage areas except for the BASIC file storage area are allocated in the following order of precedence – the TrueType font storage area, and the bit map writable character storage area. After these storage areas are allocated, the remaining area is used for the PC save area.
- (12) If the sum of the TrueType font storage area and the bit map writable character storage area, specified by this command, is the size of '896 KB minus the BASIC file storage area size', the TrueType font storage area and the bit map writable character storage area are allocated as specified. In this case, however, there is no PC save area.
- (13) If the sum of TrueType font storage area and the bit map writable character storage area, specified by this command, exceeds the size of '896 KB minus the BASIC file storage area size', the TrueType font storage area is allocated as specified with the highest priority. Then, the remaining area is allocated to the bit map writable character storage area. There is no PC save area.
- (14) When "00" (0 KB) is specified for each of the TrueType font storage area and the bit map writable character storage area, the storage area is not allocated.
- (15) If the size of '896 KB minus the BASIC file storage area size' or more is specified for either the TrueType font storage area or the bit map writable character storage area, each area other than the BASIC file storage area is allocated as specified. For example, when setting "10" or "11" for the size of the TrueType font storage area while the BASIC file storage area secures "4" (256KB), the entire storage areas except the BASIC file storage area are allocated to the TrueType font storage area. There is no bit map writable character storage area or PC save area.

Refer to

- Bit Map Writable Character Command ([ESC] XD)
- Save Start Command ([ESC] XO)
- Flash Memory Format Command ([ESC] J1)
- 2-byte Writable Character Code Range Command ([ESC] XE)

Example

The TrueType font storage area and bit map writable character storage area are set to 640 KB and 192 KB, respectively.

(PC save area: 896 KB - 640KB - 192 KB = 64 KB)

[ESC] XF; 10, 03, 00 [LF] [NUL]

6.3.19 FLASH MEMORY FORMAT COMMAND

[ESC] J1

Function	Formats (initializes) the flash memory card or flash ROM on the CPU board for storage.
Format	[ESC] J1; a (, b) [LF] [NUL]
Term	a: Formatting (initializing) range A: All area of flash memory B: PC save area of flash memory C: Writable character storage area of flash memory b: Drive (Omissible. If omitted, flash ROM on the CPU board is selected.) 0: Flash ROM on the CPU board 1: Slot 1 on the PCMCIA board (Option) 2: Slot 2 on the PCMCIA board (Option)
Explanation	(1) Only a 4-MB flash memory card can be formatted. (2) The flash memory card can be roughly divided into the PC save area and the writable character storage area. They can be formatted (initialized) either separately or at the same time. (3) When using a new flash memory card, the area to be used must be formatted (initialized) before the PC interface command is saved or writable characters are stored. (4) After the flash memory card is formatted, the remaining memory is the PC save area (895 Kbytes) and writable character storage area (3147 Kbytes). The remaining memory is displayed on the LCD. (5) When the flash memory card is used and the already stored data (PC interface commands, writable characters, logos) is stored again, memory is consumed with every storing unless the Flash Memory Format Command ([ESC] J1) is transmitted. (6) When the label issue operation is performed after the Flash Memory Format Command is sent, the image buffer is automatically cleared. (7) When storing of writable characters, logos, or PC interface commands is not continued, the printer automatically enters the online mode (label issue operation) after about 10 seconds. In this case, the image buffer is automatically cleared.
Refer to	<ul style="list-style-type: none">• Bit Map Writable Character Command ([ESC] XD)• Save Start Command ([ESC] XO)• Save Terminate Command ([ESC] XP)
Example	[ESC] J1; A, 1 [LF] [NUL]

6.3.20 ATA CARD FORMAT COMMAND

[ESC] JA

Function	Formats (initializes) the ATA card for storage.
Format	[ESC] JA; a [LF] [NUL]
Term	a: Drive 1: Slot 1 on the PCMCIA board (Option) 2: Slot 2 on the PCMCIA board (Option)
Explanation	(1) Only up to 128-MB ATA cards manufactured by SanDisk or Hitachi, can be used. (2) When performing the label issue operation is performed after the ATA Card Format Command is sent, the image buffer is automatically cleared. (3) When storing of writable characters, logos, or PC interface commands is not continued, the printer automatically enters the online mode (label issue operation) after about 10 seconds. In this case, the image buffer is automatically cleared. (4) Before the ATA card is formatted, the Web printer function should be set to OFF.
Refer to	<ul style="list-style-type: none">• Bit Map Writable Character Command ([ESC] XA)• Save Start Command ([ESC] XV)• Save Terminate Command ([ESC] XP)
Example	[ESC] JA; 2 [LF] [NUL]

6.3.21 2-BYTE WRITABLE CHARACTER CODE RANGE COMMAND [ESC] XE

Function Sets the code range when a 2-byte writable character code is stored in flash ROM on the CPU board.

Format [ESC] XE; a₁a₁a₁a₁, b₁b₁b₁b₁, a₂a₂a₂a₂, b₂b₂b₂b₂ -----, a_na_na_na_n, b_nb_nb_nb_n [LF] [NUL]

Term
 aaaa: First character code for each range
 2020 to FFFF (Indicates the hex. data in ASCII code.)
 bbbb: No. of characters for each range
 0001 to 4000 (Indicates the hex. data in ASCII code.)

- Explanation**
- (1) For a 2-byte character code such as Kanji, the character code range may be divided into two or more. The control information area for the unnecessary codes can be deleted by designating the character code range, and the capacity of flash memory is not wasted.
 - (2) The total number of characters for each range must not exceed 0x4000 (16384 characters).
 - (3) Up to 2700 can be designated for the range.
 - (4) A character code which is not appropriate for the setting for this command cannot be stored.
 - (5) The first character code for each area to be set,p should be sent in the ascending order. Each area must not overlap. If these are not satisfied, the operation is not guaranteed.

- Refer to**
- Flash Memory Format Command ([ESC] J1)
 - Bit Map Writable Character Command ([ESC] XD)

Example In the case that Shift JIS 8140H to 83DFH: Character data is present.
 Character data is not present.

	0	1	2	3	4	5	6	7	8	9	A	B	C	D	E	F
8140																
:																
81F0																
:																
8240																
:																
82F0																
:																
8340																
:																
83D0																

[ESC] XE; 8140, 00BD, 8240, 00B7, 8340, 00BD [LF] [NUL]

6.3.22 BIT MAP WRITABLE CHARACTER COMMAND (For Flash Memory) [ESC] XD

Function	Writes writable characters and logos in the flash memory card or flash ROM on the CPU board.
Format	[ESC] XD; (Sj,) aa, b, ccc, ddd, eee, fff, ggg, h, iii ----- iii [LF] [NUL]
Term	<p>Sj: Drive in which writable characters or logos are stored (Omissible. If omitted, flash ROM on the CPU board is selected.)</p> <p>j: Drive</p> <ul style="list-style-type: none">0: Flash ROM on CPU board1: Slot 1 on the PCMCIA board (Option)2: Slot 2 on the PCMCIA board (Option) <p>aa: Writable character set</p> <ul style="list-style-type: none">• Flash memory card <p>01 to 40</p> <ul style="list-style-type: none">41 16 × 16 dots42 24 × 24 dots43 32 × 32 dots44 48 × 48 dots <ul style="list-style-type: none">• Flash ROM on the CPU board <p>01 to 40</p> <ul style="list-style-type: none">41 16 × 16 dots42 24 × 24 dots43 32 × 32 dots44 48 × 48 dots51 2-byte code character <p>b(b): Writable character code</p> <ul style="list-style-type: none">20H to FFH (Set in hex.)40H to 7EH, 80H to FCH (When the writable character set is 41 to 44)2020H to FFFFH (When the writable character is 51.) <p>ccc: Left offset</p> <ul style="list-style-type: none">000 to 719 (in dots) <p>ddd: Top offset</p> <ul style="list-style-type: none">000 to 719 (in dots) <p>eee: Character width</p> <ul style="list-style-type: none">001 to 720 (in dots) <p>fff: Character height</p> <ul style="list-style-type: none">001 to 720 (in dots) <p>ggg: Horizontal spacing/proportional spacing</p> <ul style="list-style-type: none">000 to 999 (in dots) <p>h: Type of writable character data</p> <ul style="list-style-type: none">0: Nibble mode (4 bits/byte)1: Hex. mode (8 bits/byte) <p>iii --- iii: Writable character data to be stored</p> <p>* If each parameter for left offset, top offset, character width, character height, and horizontal spacing/proportional spacing is fixed as "000", the setting is ignored when the writable character set is 41 to 44.</p>

6.3.23 BIT MAP WRITABLE CHARACTER COMMAND (For ATA Card)**[ESC] XA**

Function	Writes writable characters and logos in the ATA card.
Format	[ESC] XA, j, aa, b(b), ccc(c), ddd(d), eee(e), fff(f), ggg(g), h, iii ----- iii [LF] [NUL]
Term	<p>j: Drive</p> <p style="padding-left: 20px;">1: Slot 1 on the PCMCIA board (Option)</p> <p style="padding-left: 20px;">2: Slot 2 on the PCMCIA board (Option)</p> <p>aa: Writable character set</p> <p style="padding-left: 20px;">01 to 40</p> <p style="padding-left: 20px;">41 16 × 16 dots</p> <p style="padding-left: 20px;">42 24 × 24 dots</p> <p style="padding-left: 20px;">43 32 × 32 dots</p> <p style="padding-left: 20px;">44 48 × 48 dots</p> <p style="padding-left: 20px;">51 to 55 (2-byte code character)</p> <p>b(b): Writable character code</p> <p style="padding-left: 20px;">20H to FFH (Set in hex.)</p> <p style="padding-left: 20px;">40H to 7EH, 80H to FCH (When the writable character set is 41 to 44)</p> <p style="padding-left: 20px;">2020H to FFFFH (When the writable character set is 51 to 55)</p> <p>ccc(c): Left offset</p> <p style="padding-left: 20px;">B-SX4T: 000 to 831 (in dots)</p> <p style="padding-left: 20px;">B-SX5T: 000 to 1535 (in dots)</p> <p>ddd(d): Top offset</p> <p style="padding-left: 20px;">B-SX4T and B-SX5T: 000 to 5460 (in dots)</p> <p>eee(e): Character width</p> <p style="padding-left: 20px;">B-SX4T: 000 to 832 (in dots)</p> <p style="padding-left: 20px;">B-SX5T: 000 to 1536 (in dots)</p> <p>fff(f): Character height</p> <p style="padding-left: 20px;">B-SX4T and B-SX5T: 000 to 5460 (in dots)</p> <p>ggg(g): Horizontal spacing/proportional spacing</p> <p style="padding-left: 20px;">B-SX4T: 000 to 832 (in dots)</p> <p style="padding-left: 20px;">B-SX5T: 000 to 1536 (in dots)</p> <p>h: Type of writable character data</p> <p style="padding-left: 20px;">0: Nibble mode (4 bits/byte)</p> <p style="padding-left: 20px;">1: Hex. mode (8 bits/byte)</p> <p>iii --- iii: Writable character data to be stored</p> <p>* If each parameter for left offset, top offset, character width, character height, and horizontal spacing/proportional spacing is fixed as "000", the setting is ignored when the writable character set is 41 to 44.</p>

Explanation

- (1) Type of writable character
Up to 44 and 49 writable character sets can be stored for the flash card and the ATA card, respectively. However, the maximum number of characters varies depending on the writable character size and number of characters because of the limited memory capacity. For writable character sets 41 to 44, each writable character size is fixed.
- (2) Character code
Up to 224 characters can be stored per character set. The maximum number of characters are 40 sets × 224 characters = 8960 characters. It varies depending on the writable character size and the number of characters because of the limited memory capacity. For character sets 41 to 44, a character code consisting of 1 byte is stored. However, when the character code is called up, F0H is added to the upper digit of it, and consists of 2 bytes. In this case, up to 188 characters can be stored per character set.
- (3) Only a 4-MB flash memory card can be used for storing a writable character.
- (4) The configuration of the writable character file stored in the ATA card is as follows.

1st byte	No. of dots for left offset
2nd byte	(from upper to lower)
3rd byte	No. of dots for top offset
4th byte	(from upper to lower)
5th byte	No. of dots for character height
6th byte	(from upper to lower)
7th byte	No. of dots for character width
8th byte	(from upper to lower)
9th byte	No. of dots for horizontal spacing/proportional spacing
10th byte	(from upper to lower)
11th byte	Writable character data (Hex. data)
⋮	(If it is stored in the nibble mode, data is 8 bits/byte.)

- (5) When writable characters are stored in the ATA card, the “GAJJI” directory is created, and then the directory for each writable character set is created under the “GAJJI” directory level as shown on the next page. One writable character file is created in the writable character set directory per writable character.

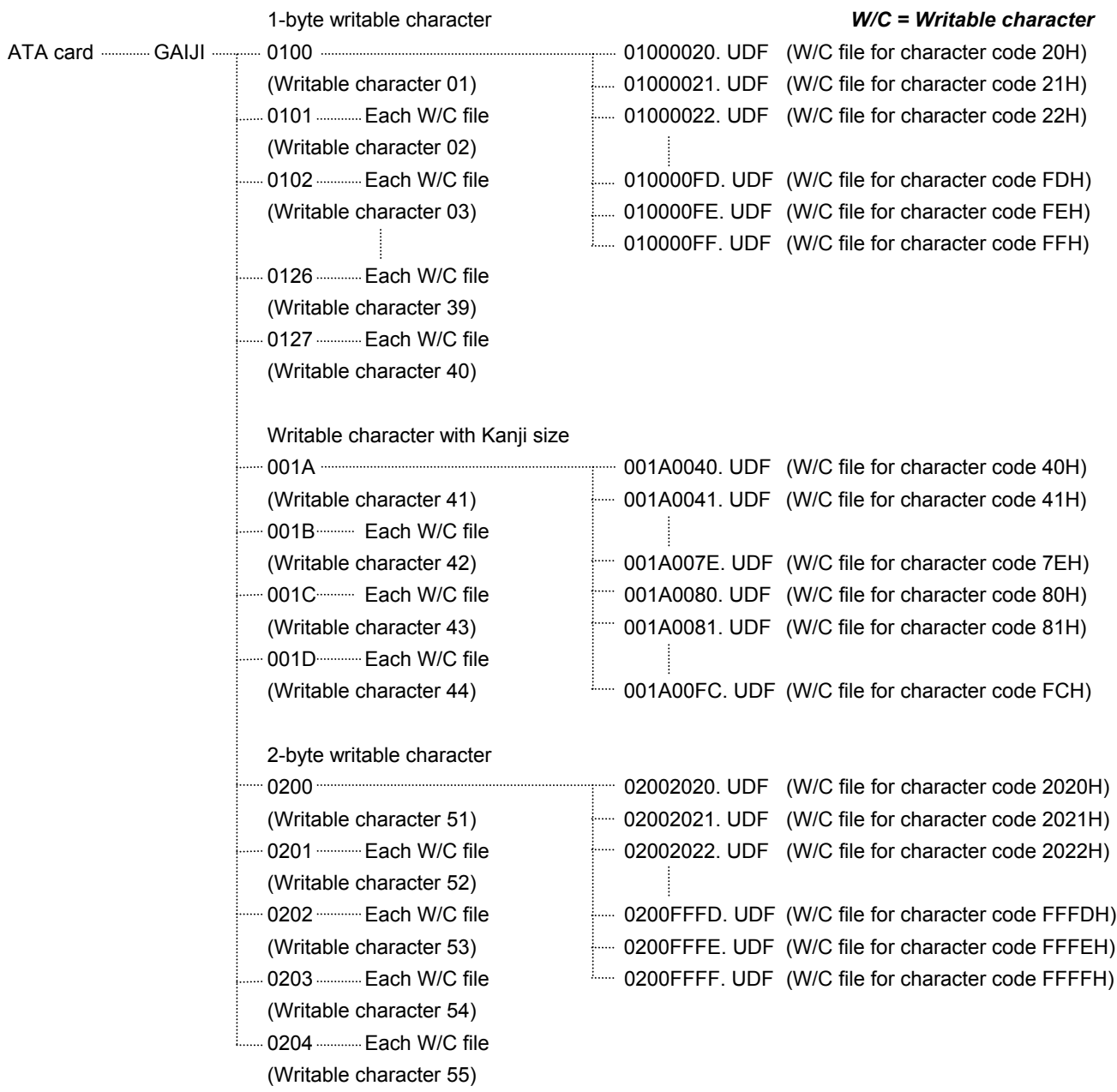

• How to assign the directory name for a writable character set

- Directory name for writable character 01 → "0100"
- Directory name for writable character 02 → "0101"
-
- Directory name for writable character 39 → "0126"
- Directory name for writable character 40 → "0127"
- Directory name for writable character 41 → "001A"
-
- Directory name for writable character 44 → "001D"
- Directory name for writable character 51 → "0200"
-
- Directory name for writable character 55 → "0204"

• How to assign the file name

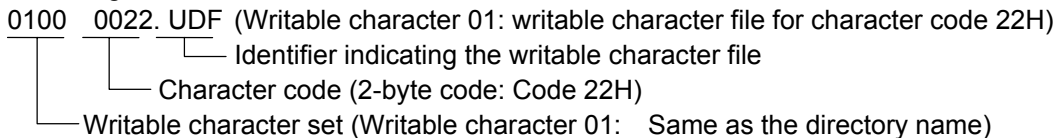

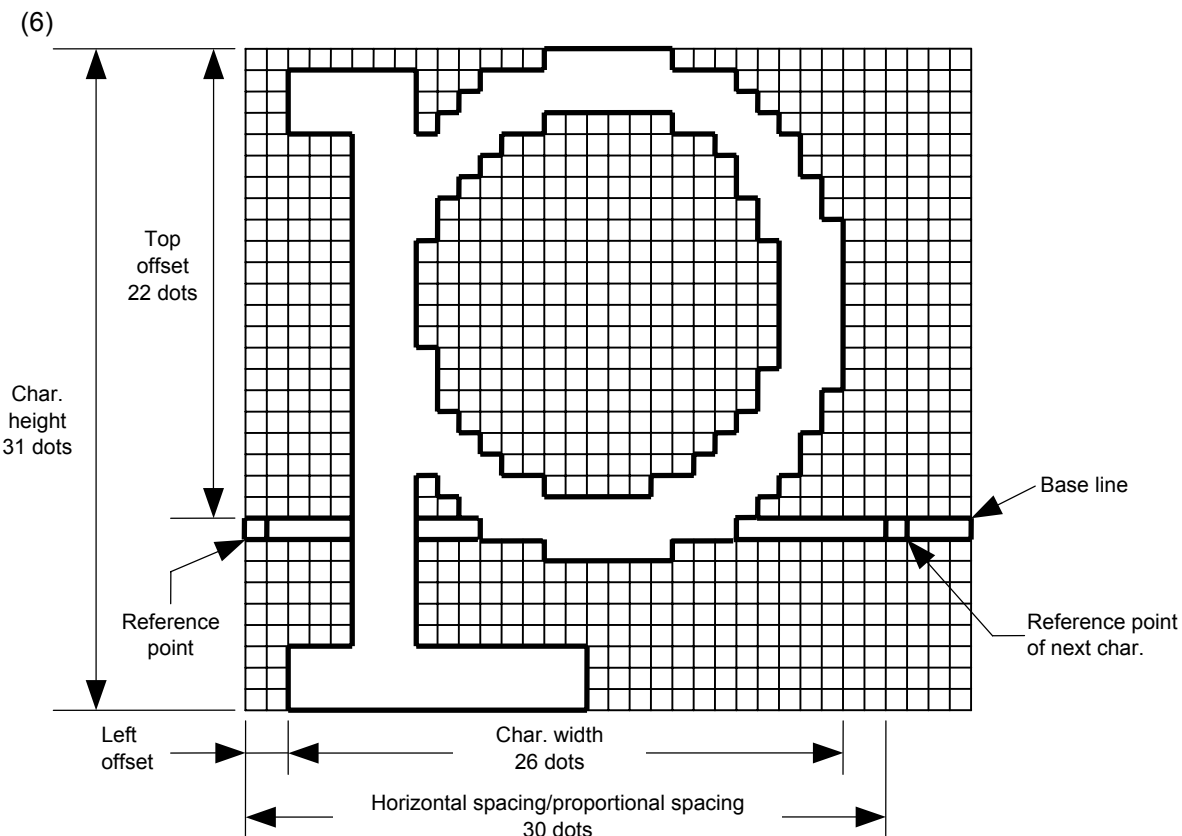

(7) Writable character set: 01 to 40, 51 to 55

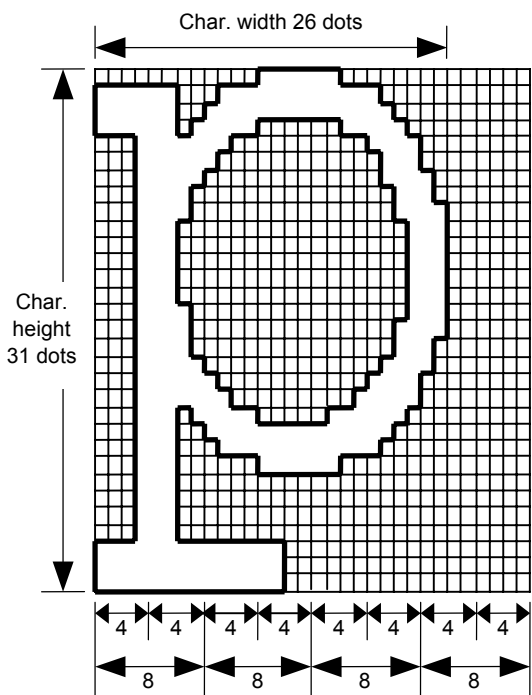

Nibble mode															
1	30H	2	30H	3	30H	4	3FH	5	3CH	6	30H	7	30H	8	30H
9	3FH	10	3CH	11	37H			.							
.															
.															
.															
.															
.															
.															
													240 30H		
241	3FH	242	3FH	243	3FH	244	3CH	245	30H	246	30H	247	30H	248	30H

Hex. mode							
1	00H	2	0FH	3	C0H	4	00H
5	FCH	6	7FH				
.							
.							
.							
.							
.							
.							
.							
			120 00H				
121	FFH	122	FCH	123	00H	124	00H

[Nibble mode]

- (1) The writable character data to be stored is separated into four dot units and sent in the following order (**1** → **248**). (High order digit: "3")
- (2) The data of writable characters to be stored is 30H to 3FH.
- (3) The minimum unit in the X direction is 8 dots. Dots with no data are transmitted as data 0.
- (4) The data count of writable characters to be stored must be as follows:
Data count of writable characters to be stored =
 $\{(No. \text{ of char. width dots} + 7)/8\} \times No. \text{ of char. height dots} \times 2$
* The value in the brackets is rounded down to the nearest whole number.

[Hex. mode]

- (1) The writable character data to be stored is separated into eight dot units and sent in the following order (**1** → **124**).
- (2) The data of writable characters to be stored is 00H to FFH.
- (3) The minimum unit in the X direction is 8 dots. Dots with no data are transmitted as data 0.
- (4) The data count of writable characters to be stored must be as follows:
Data count of writable characters to be stored =
 $\{(No. \text{ of char. width dots} + 7)/8\} \times No. \text{ of char. height dots}$
* The value in the brackets is rounded down to the nearest whole number.

Notes

- (1) With the same writable character set designated, character width and character height can be designated for each writable character code. In other words, character size can be changed for each character, thus saving memory.
- (2) Proportional spacing and descending characters are possible depending on the parameters of horizontal spacing/proportional spacing, left offset, and top offset.
- (3) When top offset is 000, the reference coordinates are at the above left when drawing because the base line is at the top. (Coordinate setting is facilitated for logos.)

(8) Writable character set: 41 (16×16 dots)

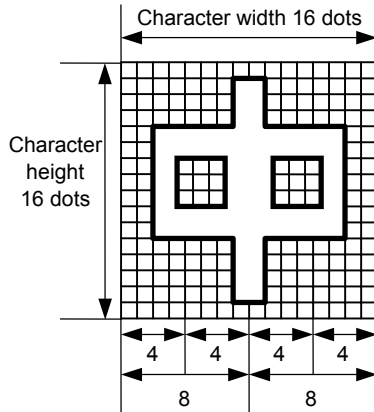

Nibble mode			
1	30H	2	30H
3	30H	4	30H
5	30H	6	31H
		7	38H
		.	
		.	
		.	
		58	31H
		59	38H
		60	30H
61	30H	62	30H
63	30H	64	30H

Hex. mode			
1	00H	2	00H
3	01H	4	80H
5	01H	6	80H
		7	01H
		.	
		.	
		.	
		26	80H
		27	01H
		28	80H
29	01H	30	80H
31	00H	32	00H

[Nibble mode]

- (1) The writable character data to be stored is separated into four dot units and sent in the following order (**1** → **64**). (High order digit: "3")
- (2) The data of writable characters to be stored is 30H to 3FH.
- (3) The data count of writable characters to be stored should be 64 bytes.

[Hex. mode]

- (1) The writable character data to be stored is separated into eight dot units and sent in the following order (**1** → **32**).
- (2) The data of writable characters to be stored is 00H to FFH.
- (3) The data count of writable characters to be stored should be 32 bytes.

* When writable character 41 is designated, the width and height of the character are both 16 dots.

(9) Writable character set: 42 (24×24 dots)

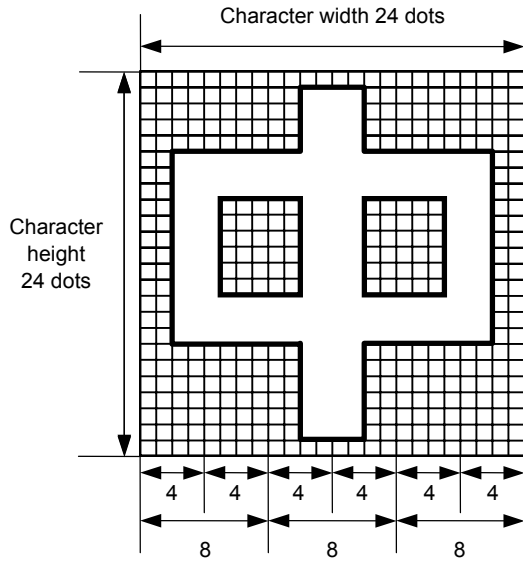

Nibble mode											
1	30H	2	30H	3	30H	4	30H	5	30H	6	30H
7	30H	8	30H	9	33H						
										137	30H
										138	30H
139	30H	140	30H	141	30H	142	30H	143	30H	144	30H

Hex. mode					
1	00H	2	00H	3	00H
4	00H	5	3CH	6	00H
67	00H	68	3CH	69	00H
70	00H	71	00H	72	00H

[Nibble mode]

- (1) The writable character data to be stored is separated into four dot units and sent in the following order (**1** → **144**). (High order digit: "3")
- (2) The data of writable characters to be stored is 30H to 3FH.
- (3) The data count of writable characters to be stored should be 144 bytes.

[Hex. mode]

- (1) The writable character data to be stored is separated into eight dot units and sent in the following order (**1** → **72**).
- (2) The data of writable characters to be stored is 00H to FFH.
- (3) The data count of writable characters to be stored should be 72 bytes.

* When writable character 42 is designated, the width and height of the character are both 24 dots.

(10) Writable character set: 43 (32×32 dots)

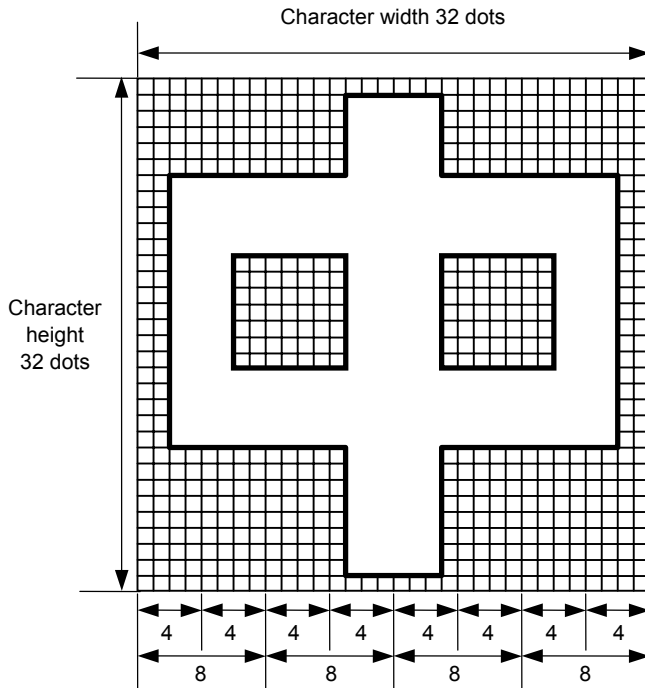

Nibble mode											
1	30H	2	30H	3	30H	4	30H	5	30H	6	30H
7	30H	8	30H	9	30H	10	30H	11	30H	12	37H
										248	30H
										249	30H
250	30H	251	30H	252	30H	253	30H	254	30H	255	30H
256	30H										

Hex. mode			
1	00H	2	00H
3	C0H	4	00H
5	00H	6	07H
7	C0H		
		123	C0H
		124	00H
125	00H	126	00H
127	00H	128	00H

[Nibble mode]

- (1) The writable character data to be stored is separated into four dot units and sent in the following order (**1** → **256**). (High order digit: "3")
- (2) The data of writable characters to be stored is 30H to 3FH.
- (3) The data count of writable characters to be stored should be 256 bytes.

[Hex. mode]

- (1) The writable character data to be stored is separated into eight dot units and sent in the following order (**1** → **128**).
- (2) The data of writable characters to be stored is 00H to FFH.
- (3) The data count of writable characters to be stored should be 128 bytes.

* When writable character 43 is designated, the width and height of the character are both 32 dots.

(11) Writable character set: 44 (48×48 dots)

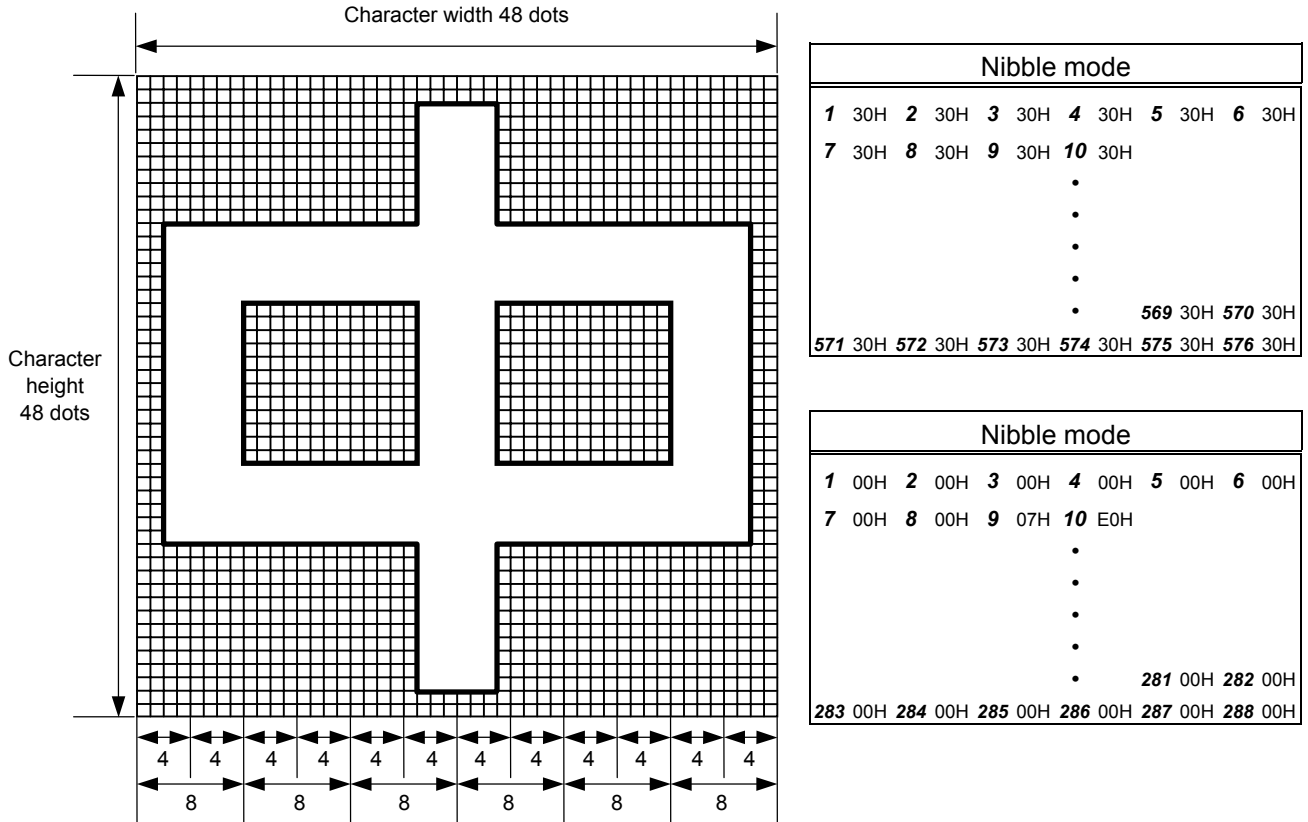

[Nibble mode]

- (1) The writable character data to be stored is separated into four dot units and sent in the following order (**1** → **576**). (High order digit: "3")
- (2) The data of writable characters to be stored is 30H to 3FH.
- (3) The data count of writable characters to be stored should be 576 bytes.

[Hex. mode]

- (1) The writable character data to be stored is separated into eight dot units and sent in the following order (**1** → **288**).
- (2) The data of writable characters to be stored is 00H to FFH.
- (3) The data count of writable characters to be stored should be 288 bytes.

* When writable character 44 is designated, the width and height of the character are both 48 dots.

Notes

- (1) No matter what character set or character code is selected, no memory will be wasted.
- (2) When a new writable character is stored, the Flash Memory Format Command ([ESC] J1) or the ATA Card Format Command ([ESC] JA) must be transmitted.
- (3) A character code already stored can be stored in the flash memory card again if the Bit Map Writable Character Store Command ([ESC] XD) is transmitted, but memory will be consumed with every storage. Memory can be efficiently used by sending the Flash Memory Format Command ([ESC] J1) before storing.
- (4) If a flash memory card is used, and a label issue operation is performed after sending the Bit Map Writable Character Command ([ESC] XD), the image buffer is cleared automatically.
- (5) When the storing operation is not continued after storing the writable character and logos, the printer automatically enters the online mode (label issue operation) after about 10 seconds. In this case, when the flash memory card is used, the image buffer will be cleared automatically.
- (6) Only a 4-MB flash memory card manufactured by Maxell can be used for storing a writable character.

Refer to

Flash Memory Format Command ([ESC] J1)
ATA Card Format Command ([ESC] JA)

Examples

Writable character set: 03
 Writable character code: 70H

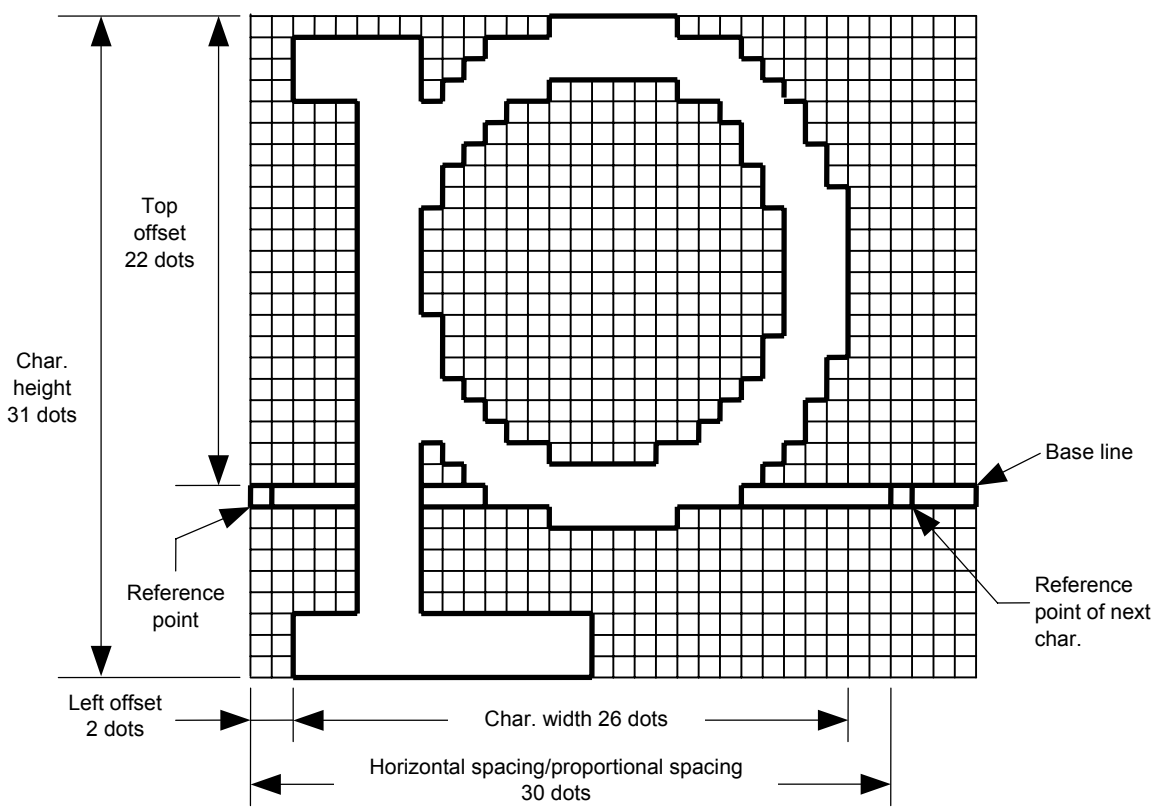

```
[ESC] J1; C [LF] [NUL]
[ESC] XD; 03, p, 002, 022, 026, 031, 030, 0, 000?<000?<7??800?<???<00?= ?03>001?
<00?001?8007001?0007801>0003801>0003<01<0001<01<0001<01<0001<01<0001<01<0001<01>
0001<01>0003<01>0003801?0007801?800?001=?07>001<???<001<7??8001<0?<
0001<0000001<0000001<0000001<000000???<0000??<0000??<0000 [LF] [NUL]
```

- * 30H = "0"
- 31H = "1"
- 32H = "2"
- 33H = "3"
- 34H = "4"
- 35H = "5"
- 36H = "6"
- 37H = "7"
- 38H = "8"
- 39H = "9"
- 3AH = "."
- 3BH = ","
- 3CH = "<"
- 3DH = "="
- 3EH = ">"
- 3FH = "?"

6.3.24 GRAPHIC COMMAND

[ESC] SG

Function	Draws graphic data.
Format	[ESC] SG; aaaa(D), bbbb(D), cccc, dddd, e, ggg --- ggg [LF] [NUL] or [ESC] SG0; aaaa(D), bbbb(D), cccc, dddd, e, ffff, ggg --- ggg [LF] [NUL]
Term	<p>aaaa(D): Print origin of X-coordinate for drawing graphic data Fixed as 4 digits (in 0.1 mm units) * If "D" is attached after a 4-digit value, the coordinate is specified in dots. 0000D ~</p> <p>bbbb(D): Print origin of Y-coordinate for drawing graphic data 4 or 5 digits (in 0.1 mm units) * If "D" is attached after a 4- or 5-digit value, the coordinate is specified in dots. 0000D ~</p> <p>cccc: No. of graphic width dots Fixed as 4 digits (in dots) However, when the graphic data "2: BMP file" or "6: PCX file" is selected, this designation is ignored. (The information of the graphic width is contained in the graphic data.)</p> <p>dddd: No. of graphic height dots 4 or 5 digits (in dots) However, when the graphic data "2: BMP file" or "6: PCX file" is selected, this designation is ignored. (The information of the graphic width is contained in the graphic data.) When "3: TOPIX compression mode" is selected for the type of graphic data: Resolution of graphic data: *only two types { 0150: 150 DPI (The data is drawn in double resolution.) { 0300: 300 DPI (The data is drawn in single resolution.)</p> <p>e: Type of graphic data [ESC] SG; -- command: 0: Nibble mode (4 dots/byte) Overwrite drawing 1: Hex. mode (8 dots/byte) Overwrite drawing 2: BMP file mode Overwrite drawing 3: TOPIX compression mode Overwrite drawing 4: Nibble mode (4 dots/byte) OR drawing 5: Hex. mode (8 dots/byte) OR drawing 6: PCX file mode Overwrite drawing 7: TOPIX compression mode XOR drawing</p> <p>[ESC] SG0; -- command: A: Printer driver compression mode Overwrite drawing</p>

fff: Data count (Effective only for [ESC] SG0; -- command)
 Fixed as 4 digits
 Represents the total number of bytes for the compressed graphic data by 32 bits in Hex.
 Range: 0 to 4,294,967,295 bytes
 (00H, 00H, 00H, 00H to FFH, FFH, FFH, FFH)

ggg --- ggg: Graphic data

Explanation

- (1) When the graphic data "0", "1", "2", "3", "6", or "A" is selected, the graphic data is drawn by overwriting the image buffer.
- (2) When the graphic data "4" or "5" is selected, the graphic data is drawn by carrying out OR between the graphic data and the data in the image buffer.

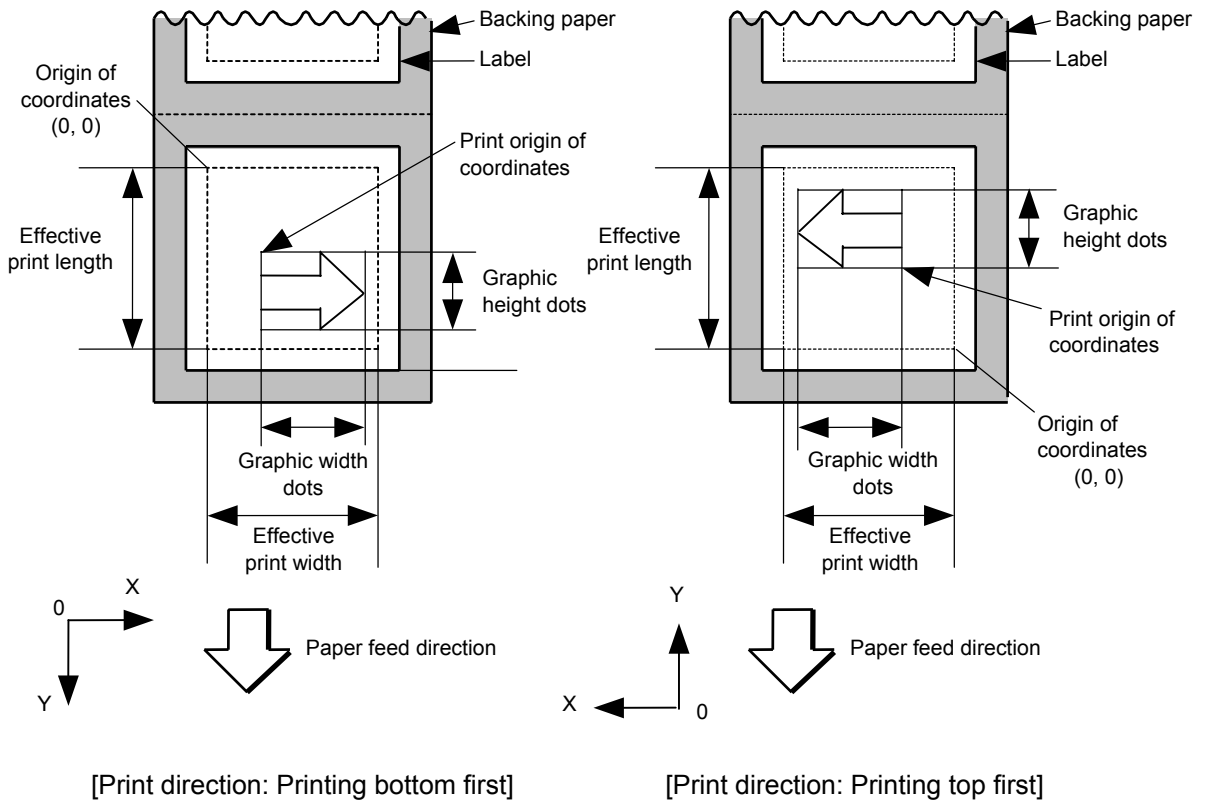

[When TOPIX compression mode is selected]

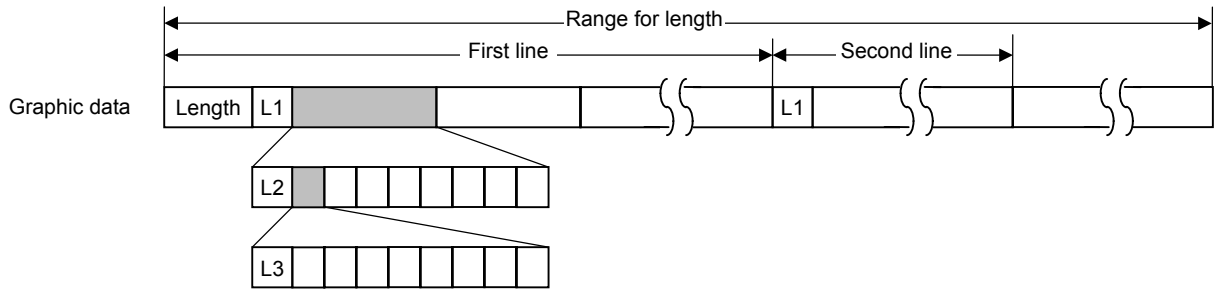

(1) Length: Total number of bytes of the graphic data (0001H ~)

Ex. Length = 20 bytes:

00	14
----	----

(2) L1 parameter: Shows in which large block (512 dots/block) the changed data is contained.

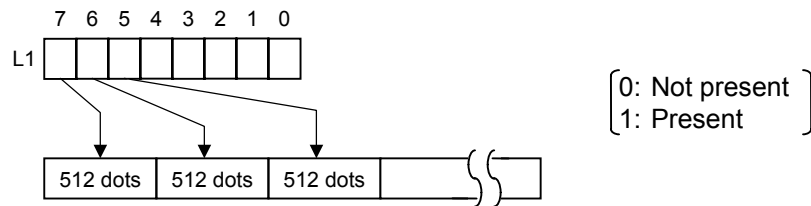

(3) L2 parameter: Shows in which medium block (64 dots/block) the changed data is contained (of the L1 large block).

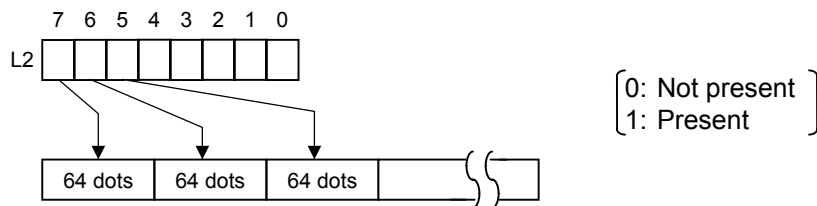

(4) L3 parameter: Shows in which small block (8 dots/block) the changed data is contained (of the L2 medium block).

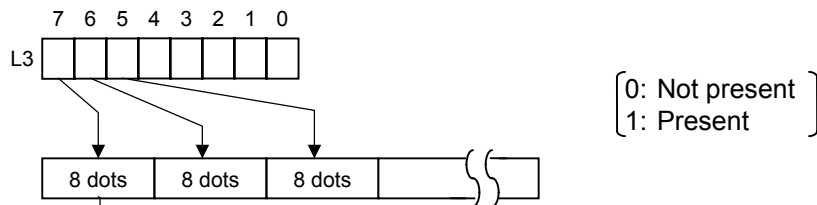

Exclusive-OR is carried out between the current image data and the image data one line previous. Only the changed bit is set to ON (1). The alignment of dots is MSB (left dots) and LSB (right dots).

* The graphic width for only the smaller value of either the designated value or the max. buffer size (512 KB) is drawn. The minimum unit of the data drawing is 8 dots (1 byte). If the graphic width is set to 3 dots, it will be reset to 8 dots (1 byte).

[When the printer driver compression mode is selected]

- (1) For the [ESC] SG0; -- command, only "A: Printer driver compression mode" can be selected for the type of graphic data. The parameter for the data count is attached after the parameter for the type of graphic data. When the total number of data cannot be provided by the printer driver, "00H, 00H, 00H, 00H" should be specified for the number of graphic data. However, in this case, the printer driver cannot support printing through a serial interface (RS-232C).
- (2) How to compress data

Compression is performed for every data of one line specified for the number of graphic width dots.

The data is made up in units of 8 dots. A repeated value is encoded in 2 bytes. The first byte is a numeric value n indicating that a value is repeated (-n + 1) times.

The range is between -127 and -1. The second byte is the repeated value.

If a value is not repeated, the first byte is the numeric value m. The length of the values is indicated in (m+1). The range of "m" is between 0 and 126. The length of the repetition of the value "n" and "m" should not exceed 127 and 126, respectively.

If it exceeds the range, it should be divided into blocks of repetition.

When the same contents as the data for 1 line appear repeatedly in the next line and after, the number of lines in which the same contents appear is encoded in 2 bytes. The first byte is fixed as 127. The second byte indicates "N" times that the same contents are repeated. Its range is between 1 and 255. "N" should not exceed 255. If it exceeds the range, the data for the excess number of times should be compressed as the new data of 1 line, and the remaining number of repetitions should be encoded.

[Example]

Data before being compressed (Width: 120 dots, Height: 300 lines)

Line No.	Graphic data
1	AAh AAh AAh AAh AAh AAh AAh BBh CCh DDh EEh FFh FFh FFh FFh
2	AAh AAh AAh AAh AAh AAh AAh BBh CCh DDh EEh FFh FFh FFh FFh
	⋮
299	AAh AAh AAh AAh AAh AAh AAh BBh CCh DDh EEh FFh FFh FFh FFh
300	AAh AAh AAh AAh AAh AAh AAh BBh CCh DDh EEh FFh FFh FFh FFh

Data after being compressed

Line No.	Graphic data
1	<u>FAh AAh</u> <u>03h BBh CCh DDh EEh FEh FFh</u>
2 to 256	7FH FFH
257	<u>FAh AAh</u> <u>03h BBh CCh DDh EEh FEh FFh</u>
258 to 300	7FH 2BH

FAh = -6
-(-6) + 1 = 7
AAh is repeated 7 times.

03h = 3
3 + 1 = 4
4-byte data (BBh CCh DDh EEh) without repetition

FEh = -2
-(-2) + 1 = 3
FFh is repeated 3 times.

Notes

- (1) The print origin of coordinates must be set so that the result of drawing the graphic data will be within the effective print area set by the Label Size Set Command ([ESC] D).
- (2) The number of graphic width dots and the number of graphic height dots must also be set so that the result of drawing the graphic data will be within the effective print area set by the Label Size Set Command ([ESC] D) in the same manner as the above.
- (3) Both width and height are 8 dots/mm and 12 dots/mm for the B-SX4T and the B-SX5T, respectively.
- (4) The actual result of drawing may deviate within ± 0.5 mm and ± 0.33 mm for the B-SX4T and the B-SX5T, respectively, in the X direction with respect to the designated print origin of the X-coordinate.

To draw the received graphic data at high speed, the data is directly developed in the image buffer without applying correction to each bit with respect to the designated X-coordinate. Consequently, an error of up to 4 bits occurs.

[Effective print area]													[mm]	
Item	Model		B-SX4T					B-SX5T						
	Issue mode		Batch	Strip	Cut				Batch	Strip	Cut			
					Swing cutter	Rotary cutter		Swing cutter			Rotary cutter			
						Head-up operation not performed	Head-up operation performed				Head-up operation not performed	Head-up operation performed		
Effective print width		Min.	10.0					10.0						
		Max.	104.0					128.0						
Effective print length	Label	Min.	6.0	21.4	23.0	3 ips:	3 ips:	6.0	21.4	23.0	3 ips:	3 ips:		
						79.0	30.0				79.0	30.0		
						6 ips:	6 ips:				6 ips:	6 ips:		
		91.0	30.0	87.0	30.0									
		10 ips: –	10 ips: –	8 ips:	8 ips:									
		(NOTE 1)	(NOTE 1)	98.0	30.0									
	Max.	1496.0		1492.0		1496.0		1492.0						
	Tag	Min.	8.0	–	23.4	3 ips: 28.0		8.0	–	23.4	3 ips: 28.0			
6 ips: 28.0						5 ips: 28.0								
10 ips: – (NOTE 1)						8 ips: 36.0								
Max.	1498.0		1498.0		1498.0		1498.0							

NOTE 1: The use of the rotary cutter at 10 ips is not supported for the B-SX4T.

Examples

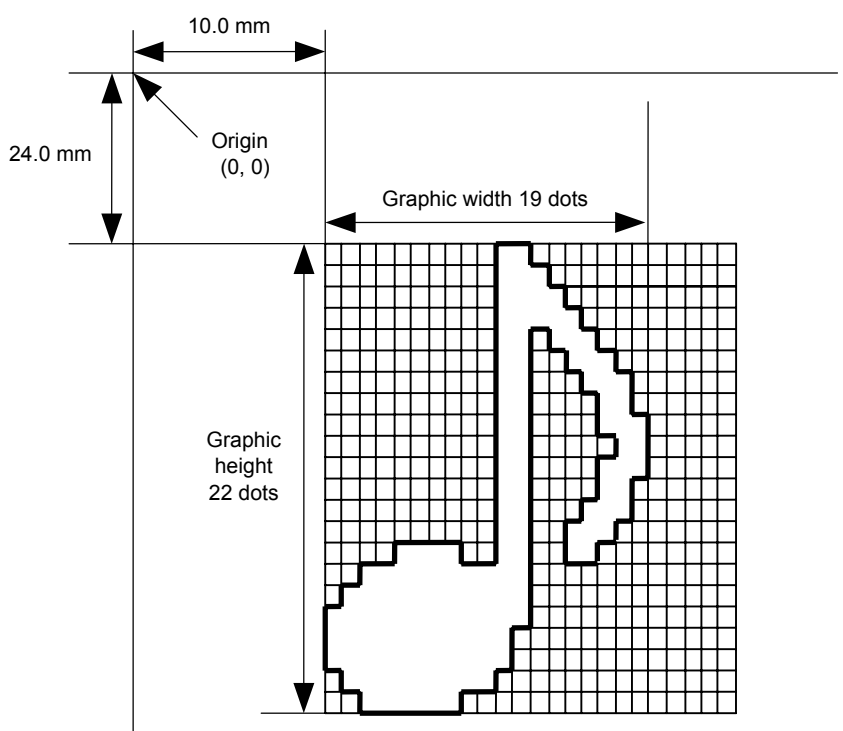

```
[ESC] C [LF] [NUL]
[ESC] SG; 0100, 0240, 0019, 0022, 0, 003000003800003<00003>000037000033800031
<00030<00030>00030600030>00030<00031<00033800?33003??0007??000??000??
>000??>0007? <0003?0000 [LF] [NUL]
[ESC] XS; I, 0001, 0002C3000 [LF] [NUL]
```

- | | |
|-------------|-----------|
| * 30H = "0" | 38H = "8" |
| 31H = "1" | 39H = "9" |
| 32H = "2" | 3AH = "." |
| 33H = "3" | 3BH = "," |
| 34H = "4" | 3CH = "<" |
| 35H = "5" | 3DH = "=" |
| 36H = "6" | 3EH = ">" |
| 37H = "7" | 3FH = "?" |

[TOPIX compression mode]

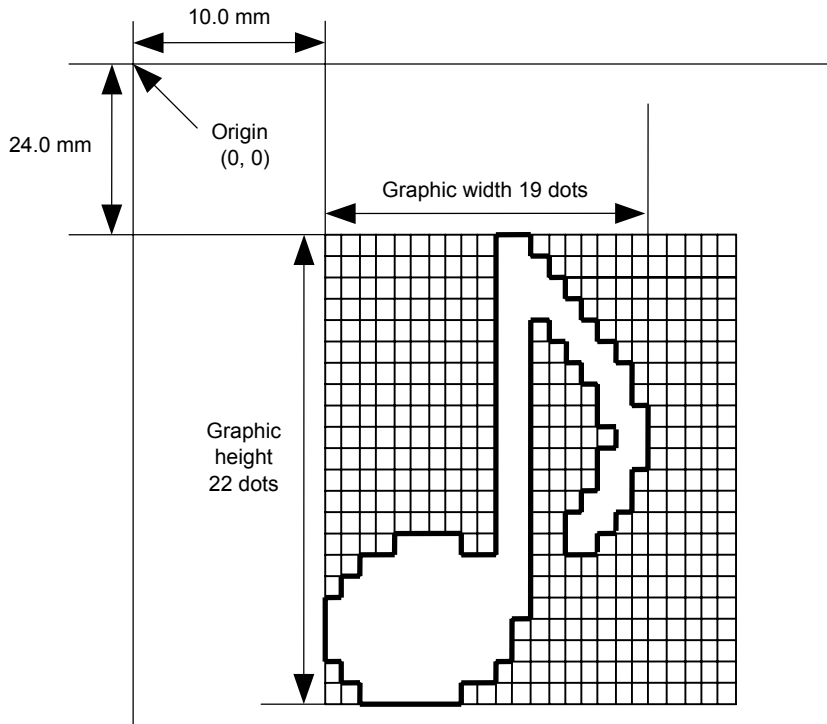

[ESC] SG; 0100, 0240, 0019, 0300, 3, 00 5C 80 80 40 30
 Length L1 L2 L3 Data (1st line)

80 80 40 08 80 80 40 04 80 80 40 02 80 80 40 09
 (2nd line) (3rd line) (4th line) (5th line)

80 80 60 04 80 80 80 60 02 40 80 80 40 01 80 80 20 20
 (6th line) (7th line) (8th line) (9th line)

80 80 20 80 80 80 20 80 80 80 20 20 80 80 40 01
 (10th line) (11th line) (12th line) (13th line)

80 80 60 02 40 80 80 A0 0F 80 80 80 C0 30 C3 80 80 80 40
 (14th line) (15th line) (16th line) (17th line)

80 80 80 80 80 80 40 10 00 80 80 C0 80 20 80 80 C0 40 C0 [LF] [NUL]
 (18th line) (19th line)(20th line) (21st line) (22nd line)

6.3.25 SAVE START COMMAND (For Flash Memory)

[ESC] XO

Function	Declares the start of saving PC interface commands. (Places the printer in the mode where PC interface commands are written in flash memory.)
Format	[ESC] XO; aa, (Sb,) c [LF] [NUL]
Term	aa: Identification number to be used for saving in flash memory or calling 01 to 99 Sb: Drive in which the PC interface command is stored (Omissible. If omitted, flash ROM on the CPU board is selected.) b: Drive 0: Flash ROM on the CPU board 1: Slot 1 on the PCMCIA board (Option) 2: Slot 2 on the PCMCIA board (Option) c: Status response at save time 0: No status response made 1: Status response made
Notes	(1) After sending the Save Start Command ([ESC] XO), any command other than the following will be saved into flash memory without being analyzed. <ul style="list-style-type: none">• Save Start Command ([ESC] XO)• Save Terminate Command ([ESC] XP)• Saved Data Call Command ([ESC] XQ, [ESC] XT)• Bit Map Writable Character Command ([ESC] XD, [ESC] XA)• Reset Command ([ESC] WR)• Status Request Command ([ESC] WS)• Flash Memory Format Command ([ESC] J1)• ATA Card Format Command ([ESC] JA) (2) No error check is made for the commands at save time. (3) Up to 64 KB can be saved per a save.
Refer to	<ul style="list-style-type: none">• Save Terminate Command ([ESC] XP)• Flash Memory Format Command ([ESC] J1)
Examples	[ESC] J1; B [LF] [NUL] [ESC] XO; 01, 0 [LF] [NUL] [ESC] D0508, 0760, 0468 [LF] [NUL] [ESC] T20C30 [LF] [NUL] [ESC] C [LF] [NUL] [ESC] PC001; 0200, 0125, 1, 1, A, 00, B [LF] [NUL] [ESC] PC002; 0650, 0550, 2, 2, G, 33, B, +0000000001 [LF] [NUL] [ESC] XP [LF] [NUL]

6.3.26 SAVE START COMMAND (For ATA Card)

[ECS] XV

Function	Declares the start of saving PC interface commands. (Places the printer in the mode where PC interface commands are written in the ATA card.)
Format	[ESC] XV; dddddddd, b, c [LF] [NUL]
Term	ddddddd: Identifier to be used for saving in the ATA card or calling File name using from 1 to 8 characters Available characters: A to Z: A to Z (in both upper and lower case) 0 to 9: Numerals from 0 to 9 Symbols: !, ", #, \$, %, &, ',), (, -, ^, _, {, }, ~ b: Drive 1: Slot 1 on the PCMCIA board (Option) 2: Slot 2 on the PCMCIA board (Option) c: Status response at save time 0: No status response made 1: Status response made
Explanation	(1) When the PC interface command is stored in the ATA card, directory "PCSAVE" is created, and then the directory "Specified file name. PCS" is created under the "PCSAVE" directory level. (2) Up to about 1 MB can be saved per a save.
Notes	(1) After sending the Save Start Command ([ESC] XV), any command other than the following will be saved into the ATA card without being analyzed. <ul style="list-style-type: none">• Save Start Command ([ESC] XO)• Save Terminate Command ([ESC] XP)• Saved Data Call Command ([ESC] XQ, [ESC] XT)• Bit Map Writable Character Command ([ESC] XD, [ESC] XA)• Reset Command ([ESC] WR)• Status Request Command ([ESC] WS)• Flash Memory Format Command ([ESC] J1)• ATA Card Format Command ([ESC] JA) (2) No error check is made for the commands at save time.
Refer to	<ul style="list-style-type: none">• Save Terminate Command ([ESC] XP)• Flash Memory Format Command ([ESC] JA)
Examples	[ESC] JA; B [LF] [NUL] [ESC] XV; PC_SAVE, 1, 0 [LF] [NUL] [ESC] D0508, 0760, 0468 [LF] [NUL] [ESC] T20C30 [LF] [NUL] [ESC] C [LF] [NUL] [ESC] PC001; 0200, 0125, 1, 1, A, 00, B [LF] [NUL] [ESC] PC002; 0650, 0550, 2, 2, G, 33, B, +0000000001 [LF] [NUL] [ESC] XP [LF] [NUL]

6.3.27 SAVE TERMINATE COMMAND

[ESC] XP

Function	Declares the termination of saving PC interface commands.
Format	[ESC] XP [LF] [NUL]
Note	If the storing operation is not continued after the PC interface command is stored, the printer enters the online mode (label issue operation) after about 10 seconds. In this case, the image buffer will be cleared automatically.
Refer to	Save Start Command ([ESC] XO, [ESC] XV)

6.3.28 SAVED DATA CALL COMMAND (For Flash Memory) [ESC] XQ

Function	Calls PC interface commands saved in flash memory.
Format	[ESC] XQ; aa, (Sb,) c, d [LF] [NUL]
Term	aa: Identification number of the file to be called from the flash memory card 01 to 99 Sb: Drive from which the command is called (Omissible. If omitted, flash ROM on the CPU board is selected.) b: Drive 0: Flash ROM on the CPU board 1: Slot 1 on the PCMCIA board (Option) 2: Slot 2 on the PCMCIA board (Option) c: Status response when the data is called up 0: No status response made 1: Status response made d: Auto call at power on time L: Auto call M: No auto call
Notes	(1) If the relevant save identification number is not found, an error will result. (2) However, if no save identification number subject to auto call is found with the option for auto call at power on time selected, the option for no auto call will be selected causing no error. (3) If a command error is found in the PC interface command in auto call at power on time by the Saved Data Call Command, a command error will result. After an error has occurred, the power must be turned off. The option for no auto call is selected when the power is turned on again. (4) The printer enters the online mode (label issue operation) when the Save Data Call Command is sent after the Save Terminate Command.
Refer to	<ul style="list-style-type: none">• Save Start Command ([ESC] XO)• Save Terminate Command ([ESC] XP)
Examples	[ESC] XQ; 01, 0, L [LF] [NUL] [ESC] RC001; Sample [LF] [NUL] [ESC] RC002; 100 [LF] [NUL] [ESC] XS; I, 0002, 0002C3000 [LF] [NUL]

6.3.29 SAVED DATA CALL COMMAND (For ATA Card)

[ESC] XT

Function	Calls PC interface commands saved in the ATA card.
Format	[ESC] XT; dddddddd, b, c, d [LF] [NUL]
Term	ddddddd: Identifier for the file to be called from the ATA card File name within 8 characters b: Drive 1: Slot 1 on the PCMCIA board (Option) 2: Slot 2 on the PCMCIA board (Option) c: Status response when the data is called up 0: No status response made 1: Status response made d: Auto call at power on time L: Auto call M: No auto call
Notes	(1) If the relevant save identifier is not found, an error will result. (2) However, if no save number subject to auto call is found with the option for auto call at power on time selected, the option for no auto call will be selected causing no error. (3) If a command error is found in the PC interface command in auto call at power on time by the Saved Data Call Command, a command error will result. After an error has occurred, the power must be turned off. The option for no auto call is selected when the power is turned on again. (4) The printer enters the online mode (label issue operation) when the Save Data Call Command is sent after the Save Terminate Command.
Refer to	<ul style="list-style-type: none">• Save Start Command ([ESC] XV)• Save Terminate Command ([ESC] XP)
Examples	[ESC] XT; PC_SAVE, 1, 0, M [LF] [NUL] [ESC] RC001; Sample [LF] [NUL] [ESC] RC002; 100 [LF] [NUL] [ESC] XS; I, 0002, 0002C3000 [LF] [NUL]

6.3.30 HEAD BROKEN DOTS CHECK COMMAND

[ESC] HD

Function	Checks the thermal head for broken dots.
Format	[ESC] HD001 (, a) [LF] [NUL].....All broken dots check [ESC] HD003, s ₁ s ₁ s ₁ s ₁ , e ₁ e ₁ e ₁ e ₁ , s ₂ s ₂ s ₂ s ₂ , e ₂ e ₂ e ₂ e ₂ ,--- s ₈ s ₈ s ₈ s ₈ , e ₈ e ₈ e ₈ e ₈ (, a) [LF] [NUL] Partial broken dots check
Term	a: Check result status response (Omissible) A: Status response made (If omitted, the check result status response is not made.) s ₁ s ₁ s ₁ s ₁ --- s ₈ s ₈ s ₈ s ₈ : Start coordinate of partition Fixed as 4 digits (in units of 0.1 mm) e ₁ e ₁ e ₁ e ₁ --- e ₈ e ₈ e ₈ e ₈ : End coordinate of partition Fixed as 4 digits (in units of 0.1 mm)
Explanation	(1) The Head Broken Dots Check Command is subject to batch processing. If the Label Issue Command for 100 labels is transmitted, followed by the Head Broken Dots Check Command, the head broken dots check will be executed after issuing 100 labels. (2) For the all broken dots check, the head broken dots check will be made on all the heater elements of the thermal head. (3) If the check result is found to be normal when the check result status response is set so that it is not made, the next command is processed. If the check result is found to be abnormal, an error occurs. Whether or not the status is sent when an error occurs is determined according to the setting for the status response specified by the Issue Command. If the check result is found to be normal when the check result status response is set, a head broken dots check normal end status is sent, and then the next command is processed. If the check result is found to be abnormal, the head broken dots error status is sent, and then the printer stops. Status for normal end [SOH] [STX] "0020000" [EXT] [EOT] [CR] [LF] Status for head broken dots error [SOH] [STX] "1720000" [EXT] [EOT] [CR] [LF] (4) All broken dots check takes approx. 1 second. (5) Partial broken dots check: <ul style="list-style-type: none"> • Up to 8 positions for the range can be designated. However, the range is omissible, if it is less than 8 positions. • When the value set for the start coordinate is larger than the value set for the end coordinate, the end coordinate is recognized and processed as the start coordinate, and the start coordinate is recognized and processed as the end coordinate. • Plural coordinates specifying the range can be designated at the same time. • If a coordinate beyond the head width is specified, it is processed the same as when the max. value is designated. Therefore, a command error does not occur.
Examples	[ESC] C [LF] [NUL] [ESC] RC001; Sample [LF] [NUL] [ESC] RC002; 001 [LF] [NUL] [ESC] XS; I, 0002, 0002C3000 [LF] [NUL] [ESC] HD001 [LF] [NUL]

6.3.31 MESSAGE DISPLAY COMMAND

[ESC] XJ

Function Displays the message on the upper line of the LCD.

Format [ESC] XJ; aaa ----- aaa [LF] [NUL]

Term aaa ----- aaa: Display data (16 digits)

Explanation When the printer receives the Message Display Command, it displays the message on the upper line of the LCD then enters a pause state after processing the received data (after completing the label issue, if the Issue Command has been sent). The pause state is cleared by pressing the [RESTART] key and the LCD displays the normal message. After the pause state is cleared, the printer resumes processing the received data following the Message Display Command.

- Notes**
- (1) 16 characters are displayed. When the display data is less than 16 characters, the blank data is processed as spaces. When the display data exceeds 16 characters, the excess data is discarded.
 - (2) During a pause, a halt due to an error, or a head open state, the Message Display Command is not processed even if it is received. In this case, the command is processed after the above state is cleared.
 - (3) The following data can be displayed.

If a code other than the following data is received, “?” is displayed or a command error results.

	2	3	4	5	6	7	A	B	C	D
0	SP	0	@	P	`	p				
1	!	1	A	Q	a	q				
2	”	2	B	R	b	r				
3	#	3	C	S	c	s				
4	\$	4	D	T	d	t				
5	%	5	E	U	e	u				
6	&	6	F	V	f	v				
7	'	7	G	W	g	w				
8	(8	H	X	h	x				
9)	9	I	Y	i	y				
A	*	:	J	Z	j	z				
B	+	;	K	[k	{				
C	,	<	L	\	l					
D	-	=	M]	m	}				
E	.	>	N	^	n	→				
F	/	?	O	_	o	←				

* The shaded parts are Japanese. They are omitted here.

Examples

- ① Load paper.
- ② Feed one label.
- ③ Issue 4 labels.

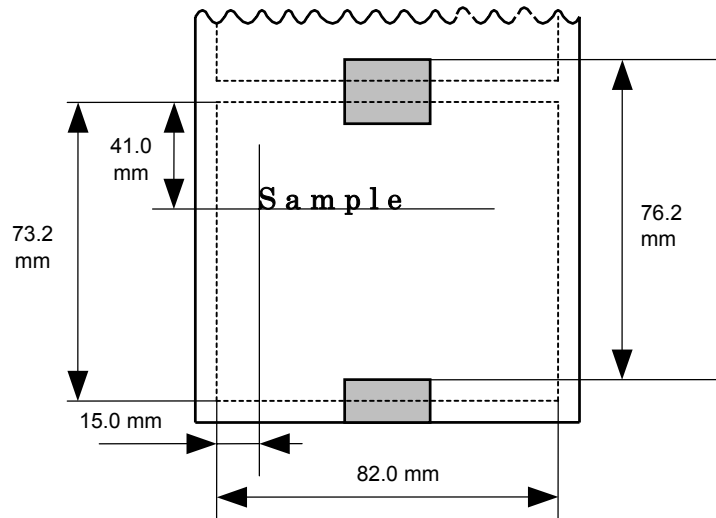

- ④ Message "Please set [Tag]" is displayed.
- ⑤ Change paper.
- ⑥ Press the [RESTART] key.
- ⑦ Feed one label.
- ⑧ Issue 2 labels.

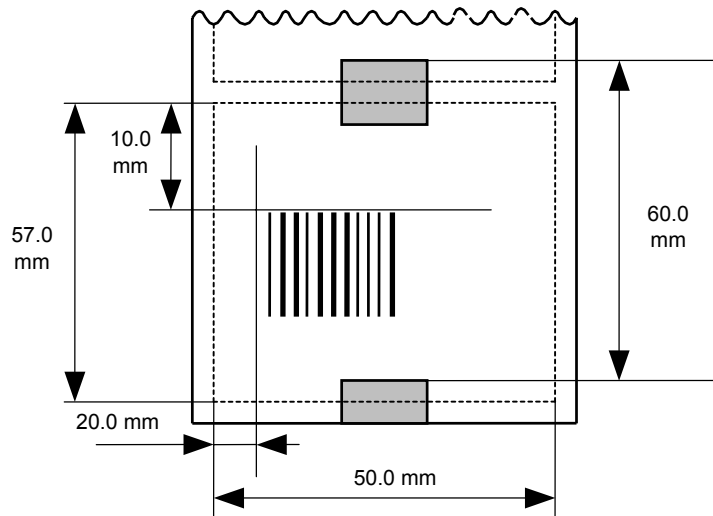

```
[ESC] D0762, 0820, 0732 [LF] [NUL]
[ESC] T11C30 [LF] [NUL]
[ESC] C [LF] [NUL]
[ESC] PC001; 0150, 0410, 1, 1, A, 00, B [LF] [NUL]
[ESC] RC001; Sample [LF] [NUL]
[ESC] XS; I, 0004, 0011C3001 [LF] [NUL]
[ESC] XJ; Please set [Tag] [LF] [NUL]
[ESC] D0600, 0500, 0570 [LF] [NUL]
[ESC] T11C30 [LF] [NUL]
[ESC] C [LF] [NUL]
[ESC] XB01; 0200, 0100, 3, 1, 03, 03, 08, 08, 03, 0, 0150 [LF] [NUL]
[ESC] RB01; 12345 [LF] [NUL]
[ESC] XS; I, 0002, 0011C3001 [LF] [NUL]
```

6.3.32 RESET COMMAND

[ESC] WR

Function	Returns the printer to its initial state.
Format	[ESC] WR [LF] [NUL]
Explanation	The printer is returned to the same state as when the power is turned on. When the printer receives this command during printing, it returns to its initial state after issuing the label which is being printed. The next command must not be sent while the printer is performing initial processing after this command is transmitted.
Notes	<ol style="list-style-type: none">(1) When the printer receives a command in the system mode, only the Reset Command can be processed and any other commands cannot be processed.(2) If a command error or communication error occurs when receiving the Reset Command, the error message is displayed in the online mode. However, it is not displayed in the system mode.(3) After the code of the Bit Map Writable Character Command ([ESC] XD) or the Graphic Command ([ESC] SG) is received, the Reset Command is not processed until the printer receives the data specified for the type of data.
Example	[ESC] WR [LF] [NUL]

6.3.33 STATUS REQUEST COMMAND

[ESC] WS

Function	Sends the printer status to the host computer.
Format	[ESC] WS [LF] [NUL]
Explanation	This command makes the printer send its status regardless of the setting of “status response/no status response.” The status to be transmitted is the current printer status, and indicates the latest status only. The remaining count indicates the remaining count of the batch currently being printed. No remaining count of the batch waiting to be printed is transmitted.
Notes	<ol style="list-style-type: none">(1) This command is available for the RS-232C, USB, Centronics interfaces, and socket communications. However, when SPP mode of Centronics is selected, the printer returns a status to the Nibble mode negotiation immediately after this command is received. When ECP mode of Centronics is selected, the printer returns a status to the reverse request immediately after this command is received.(2) The status is returned only to the interface which sent this command.(3) After the code of the Bit Map Writable Character Command ([ESC] XD) or Graphic Command ([ESC] SG) is received, the Status Request Command is not processed until the printer receives the data specified for the type of data.(4) A max. delay of 20 msec may occur until the printer sends the status after receiving the Status Request Command.(5) The interval from when the Status Request Command is sent to when the next Status Request Command is sent should be 20 msec or more. If the interval is less than 20 msec, the printer may fail to receive the Status Request Command.
Example	[ESC] WS [LF] [NUL]

6.3.34 RECEIVE BUFFER FREE SPACE STATUS REQUEST COMMAND [ESC] WB

Function	Sends information on the printer status and the free space of the receive buffer to the host.
Format	[ESC] WB [LF] [NUL]
Explanation	(1) This command makes the printer send information on its status and free space of the receive buffer regardless of the setting of "status response/no status response." The status to be transmitted is the current printer status, and indicates the latest status only. The remaining count indicates the remaining count of the batch currently being printed. No remaining count of the batch waiting to be printed is transmitted. Free space of the receive buffer for the interface which sent this command, is returned to the host.
Notes	(1) This command is available for the RS-232C, USB, Centronics interfaces, and socket communications. However, when SPP mode of Centronics is selected, the printer returns a status to the Nibble mode negotiation immediately after this command is received. When ECP mode of Centronics is selected, the printer returns a status to the reverse request immediately after this command is received. (2) The printer returns the status only for the interface which sent this command to the host. (3) After the code of the Bit Map Writable Character Command ([ESC] XD) or Graphic Command ([ESC] SG) is received, the Status Request Command is not processed until the printer receives the data specified for the type of data. (4) A max. delay of 20 msec may occur until the printer sends the status after receiving the Status Request Command. (5) The interval from when the Status Request Command is sent to when the next Status Request Command is sent should be 20 msec or more. If the interval is less than 20 msec, the printer may fail to receive the next Status Request Command.
Example	[ESC] WB [LF] [NUL]

6.3.35 VERSION INFORMATION ACQUIRE COMMAND

[ESC] WV

Function

Sends information such as the program version of the printer.

Format

[ESC] WV [LF] [NUL]

Explanation

(1) The format of the program version data (total 27 bytes of data) to be returned to the host is as follows.

SOH		01H	
STX		02H	
Creation date	"0"	30H	Creation date of program: 9 bytes of data indicated in order of Day- Month-Year
	"1"	31H	
	"N"	48H	
	"O"	49H	
	"V"	56H	
	"2"	32H	
	"0"	30H	
	"0"	30H	
	"2"	32H	
Model	"B"	42H	Model: 7 bytes of ASCII code indicating the model
	"_"	2DH	
	"S"	53H	
	"X"	58H	
	"4"	34H	
	"T"	54H	
	SP	20H	
Version	"V"	56H	Program version: 5 bytes of data: Vx.xx └── Revision └── Version
	"1"	31H	
	"."	2EH	
	"0"	30H	
	"A"	41H	
ETX		03H	
EOT		04H	
CR		0DH	
LF		0AH	

(2) This command is one of the command types that are processed as they are received. Processing takes place starting from the ones received first. Until the process of the command previously sent is completed, the next command is not processed. Therefore, if the printer is not in the idle state when this command is sent, the program version data may not be returned immediately.

Notes

(1) This command is effective only for the serial interface (RS-232C).

6.3.36 ATA CARD INFORMATION ACQUIRE COMMAND

[ESC] WI

Function Sends information regarding the use of the ATA card to the host.

Format [ESC] WI; a, b [LF] [NUL]

Term

a: Drive
 1: Slot 1 ATA card
 2: Slot 2 ATA card

b: Information to be acquired
 A: Free space
 B: Writable character list
 C: Stored PC command save file

Explanation (1) The format of information to be returned to the host is as follows:

A: Free space

SOH	STX	"A"	Slot	Free space (Kbyte)						ETX	EOT	CR	LF
01H	02H	41H	xxH	3xH	3xH	3xH	3xH	3xH	3xH	03H	04H	0DH	0AH

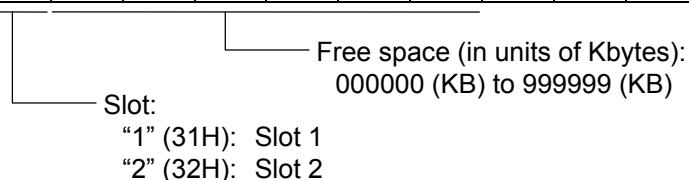

When the ATA card is not inserted into a specified slot, "00H, 00H, 00H, 00H, 00H, 00H" is returned for free space.

B: Writable character list

SOH	STX	"B"	Slot	Storage information of writable character (55 bytes)						ETX	EOT	CR	LF
01H	02H	42H	xxH	"0"/"1"	"0"/"1"	"0"/"1"	"0"/"1"	03H	04H	0DH	0AH	

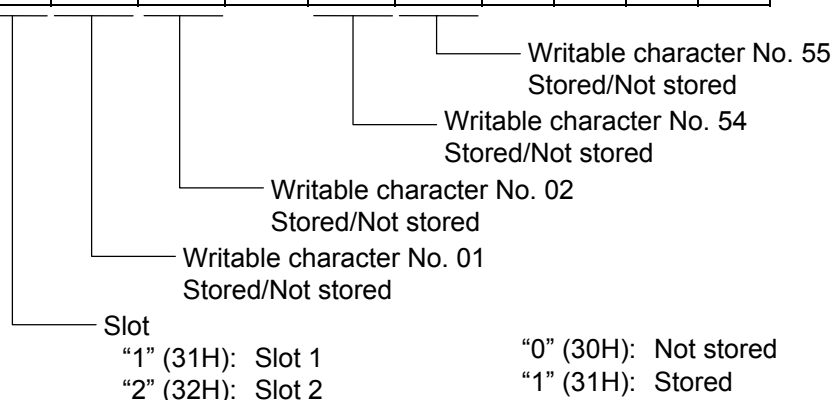

If only one writable character is stored, information of the writable character No. is set to "1" (Stored). The storage information of a specified character code can be acquired by using the ATA Card Writable Character Information Acquire Command ([ESC] WG). The storage information of the writable character has a total of 55 bytes. The writable character No. is assigned from 01 to 44, and from 51 to 55. Therefore, bytes to which Nos. 45 to 50 are assigned are sure to be set to "0" (30H). When the ATA card is not inserted in the specified slot, "00H" for the storage information of the writable character is returned.

C: Stored PC command save file

SOH	STX	"C"	Slot	Stored PC command save file name	ETX	EOT	CR	LF
01H	02H	43H	xxH	File name 1 00H File name 2 00H ... File name n 00H	03H	04H	0DH	0AH

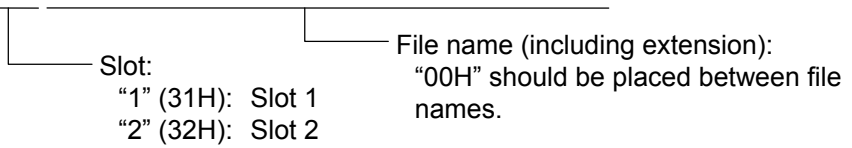

In the following cases, 1 byte of "00H" is returned as the stored PC command save file name.

- ① There is no file.
 - ② The ATA card has not been inserted in the specified slot.
- (2) This command is one of the command types that are processed as they are received. Processing takes place starting from the ones received first. Until the process of the command previously sent is completed, this command is not processed. Therefore, if the printer is not in the idle state when this command is sent, the information data may not be returned immediately.

Note

- (1) This command is effective only for the serial interface (RS-232C).

6.3.37 ATA CARD WRITABLE CHARACTER INFORMATION ACQUIRE COMMAND [ESC] WG

Function	Sends the writable character information stored in the ATA card to the host.
Format	[ESC] WG; a, bb, cc [LF] [NUL]
Term	<p>a: Drive</p> <p>1: Slot 1 ATA card</p> <p>2: Slot 2 ATA card</p> <p>bb: Writable character set</p> <p>01 to 44, 51 to 55</p> <p>cc: Writable character code</p> <p>If there is a 1-byte writable character, "00H" should be attached to the top of the data to make it 2 bytes.</p>

Explanation (1) The format of information to be returned to the host is as follows:

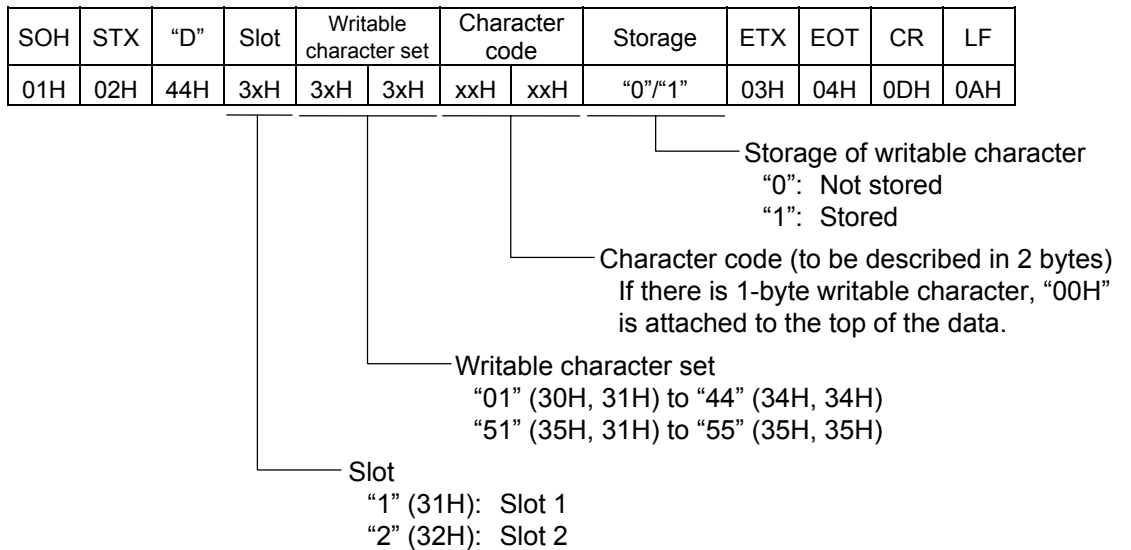

When the ATA card is not inserted in a specified slot, "00H" is returned for all information from "Writable Character Set" to "Storage" (5 bytes).

Example When the following information in the ATA card in Slot 1 is acquired:

Writable character set 44, writable character code 41H

[ESC] WG; 1, 44, (0x00) (0x41) [LF] [NUL]

* (0x00) represents data of 00H.

* (0x41) represents data of 41H.

6.3.38 PRINTER OPTION STATUS ACQUIRE COMMAND

[ESC] WN

Function Sends the information what optional devices are installed, to the host.

Format [ESC] WN [LF] [NUL]

Explanation (1) The format of information to be returned to the host is as follows:

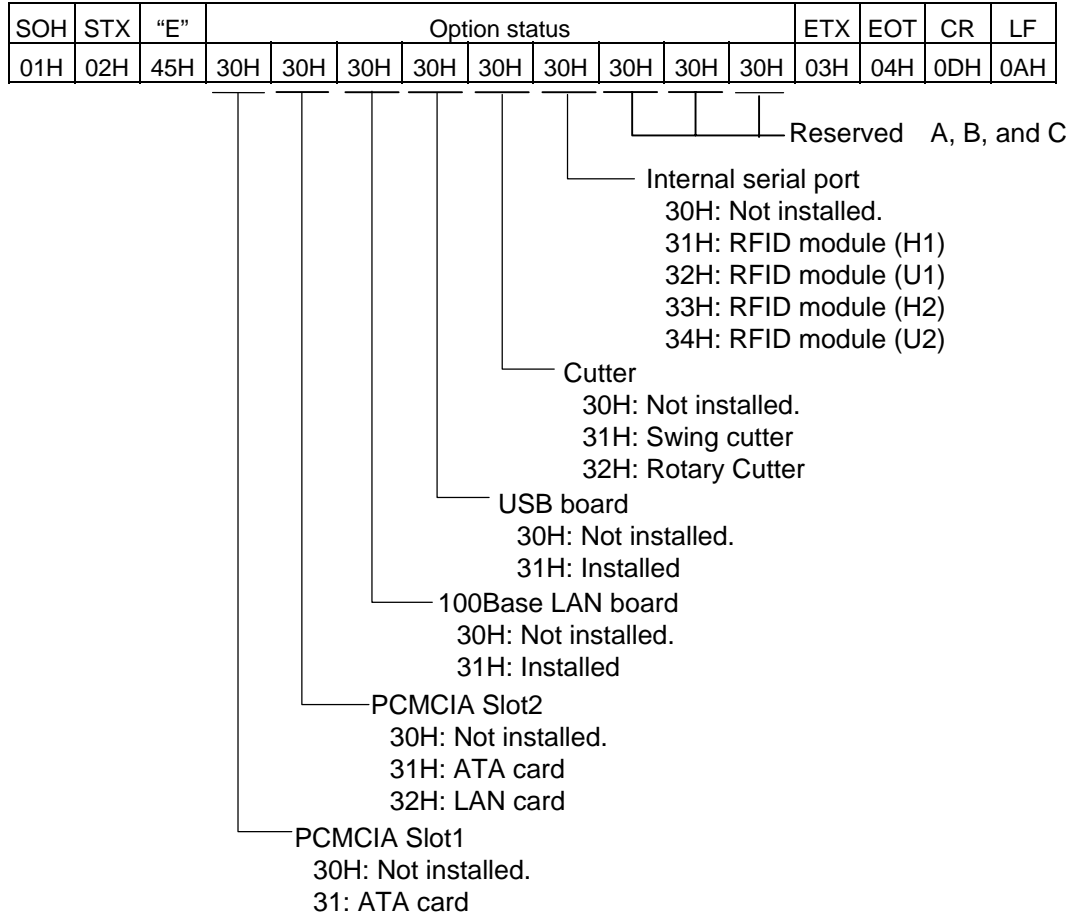

6.3.39 IP ADDRESS SET COMMAND

[ESC] IP

Function Sets the IP address to be required for the network connection.

Format [ESC] IP; a, bbb, ccc, ddd, eee [LF] [NUL]

Term

- a: IP address to be set
 - 2: Printer IP address (Initial value: 192.168.10.20)
 - 3: Gateway IP address (Initial value: 0.0.0.0)
 - 4: Subnet mask (Initial value: 255.255.255.0)
- bbb: First 8 bits: 000 to 255
- ccc: Second 8 bits: 000 to 255
- ddd: Third 8 bits: 000 to 255
- eee: Last 8 bits: 000 to 255

Explanation The IP address setting can also be made in the system mode. The setting which was last made takes effect.

Example Sets the printer IP address to "157.69.9.78".
[ESC] IP; 2, 157, 069, 009, 078 [LF] [NUL]

Function Enables or disables the socket communication, and sets the communication port number to be used.

Format [ESC] IS; a, bbbbbb [LF] [NUL]

Term

- a: 0: Socket communication is disabled.
1: Socket communication is enabled.
- bbbbbb: Port number (It must be set in 5 digits.)
00000 to 65535

Explanation These settings can also be made in the system mode. The setting which was last made takes effect.

Example To enable the socket communication and set the port number to "8000".
[ESC] IS; 1, 08000 [LF] [NUL]

6.3.40 SOCKET COMMUNICATION PORT SET COMMAND [ESC] IS

Function	Enables or disables the socket communication, and sets the communication port number to be used.
Format	[ESC] IS; a, bbbbb [LF] [NUL]
Term	a: 0: Socket communication is disabled. 1: Socket communication is enabled. bbbbb: Port number (It must be set in 5 digits.) 00000 to 65535
Explanation	These settings can also be made in the system mode. The setting which was last made takes effect.
Example	To enable the socket communication and set the port number to "8000". [ESC] IS; 1, 08000 [LF] [NUL]

6.3.41 DHCP FUNCTION SET COMMAND

[ESC] IH

Function

Enables or disables the DHCP function, and sets the DHCP client ID.

Format

[ESC] IH; a, bbbbbbbbbbbbbbbbbbbbbbbbbbbbbbbbb [LF] [NUL]

Term

a: 0: DHCP function is disabled.
1: DHCP function is enabled.

bbbbbbbbbbbbbbbbbbbbbbbbbbbbbbbb: DHCP client ID
(16 bytes of data should be described in 32 bytes in Hex.)

Explanation

- These settings can also be made in the system mode. The setting which was last made takes effect.
- “FFH” in the client ID is assumed as a terminator. Therefore, “FFH” must not be used in data.
- If “FFH” is specified as the first byte of the DHCP client ID, the printer assumes the DHCP client ID is not specified, and uses the MAC address of the LAN board installed on the printer as the DHCP client ID.

Example

To enable the DHCP function and set the DHCP client ID to “12H56HCDH”.
[ESC] IH; 1, 1256CDFFFFFFFFFFFFFFFFFFFFFFFFFFFF [LF] [NUL]

6.3.42 PASS-THROUGH COMMAND

[ESC] @002

Function Passes the serial interface data through the internal serial interface (CN14).

Format [ESC] @002; aaa, bbb --- bbb [LF] [NUL]

Term aaa: Number of bytes to be passed through
001 to 999
bbb --- bbb: Binary data to be passed through

Explanation This command is used for making a serial communication with the RF-ID module. The number of bytes of data specified by this command is output to the internal serial interface (CN14: RF-ID) without being processed. Data received from the internal serial interface (CN14: RF-ID) is output to the serial interface.

6.3.43 INTERNAL SERIAL INTERFACE PARAMETER SET COMMAND

[ESC] IZ

Function	Sets communication parameters for the internal serial interface.
Format	[ESC] IZ; a, b, c, d [LF] [NUL]
Term	a: Communication speed 0: 2400 bps 1: 4800 bps 2: 9600 bps 3: 19200 bps b: Data length 0: 7 bits 1: 8 bits c: Stop bit length 0: 1 bit 1: 2 bits d: Parity 0: None 1: Even 2: Odd

Explanation The settings by this command take effect immediately after this command is analyzed. (A restart of the printer is not required.) This command is saved into memory and is kept even if the power is turned OFF.

When a communication error occurs in the internal serial interface, the ON LINE LED goes off and the ERROR LED goes ON. "INTERNAL COM ERR" is displayed on the upper LCD, and then the printer stops due to an error.

Example To set the communication speed, the data length, the stop bit length, and the parity to 9600 bps, 8 bits, 1 bit, and even parity, respectively.
[ESC] IZ; 2, 1, 0, 1 [LF] [NUL]

6.4 COMMANDS FOR SYSTEM ADMINISTRATOR

6.4.1 PARAMETER SET COMMAND [ESC] Z2; 1

Function	Sets each parameter on the printer.
Format	[ESC] Z2; 1, abcdefghijklmnopqrstuvwxyzABCDEF GHIJK [LF] [NUL]
Term	a: Character code selection 0: PC-850 1: PC-852 2: PC-857 3: PC-8 4: PC-851 5: PC-855 6: PC-1250 7: PC-1251 8: PC-1252 9: PC-1253 A: PC-1254 B: PC-1257 C: LATIN9 D: Arabic E: UTF-8 (Supported by V4.4A or greater) b: Font "0" selection 0: 0 (without slash) 1: 0 (with slash) c: RS-232C communication speed 0: 2400 bps 1: 4800 bps 2: 9600 bps 3: 19200 bps 4: 38400 bps 5: 115200 bps d: RS-232C data length 0: 7 bits 1: 8 bits e: Stop bit length 0: 1 bit 1: 2 bits f: RS-232C parity check 0: NONE 1: EVEN 2: ODD

- g: RS-232C transmission control
- 0: XON/XOFF protocol
(No XON output when the power is turned on, no XOFF output when the power is turned OFF)
 - 1: READY/BUSY (DTR) protocol
(No XON output when the power is turned on, no XOFF output when the power is turned OFF)
 - 2: XON/XOFF + READY/BUSY (DTR) protocol:
(XON output when the power is turned on, XOFF output when the power is turned OFF)
 - 3: XON/XOFF protocol:
(XON output when the power is turned on, XOFF output when the power is turned OFF)
 - 4: RTS protocol
(No XON output when the power is turned on, no XOFF output when the power is turned OFF)
- h: Language for LCD messages
- 0: ENGLISH
 - 1: GERMAN
 - 2: FRENCH
 - 3: DUTCH
 - 4: SPANISH
 - 5: JAPANESE
 - 6: ITALIAN
- i: Forward feed standby after an issue
- 0: OFF (Not performed)
 - 1: ON (Performed)
- j: Fine adjustment direction for the stop position of the forward feed standby
- +: Increase the length of the forward feed
 - : Decrease the length of the forward feed
- kk: Fine adjustment value for the stop position of the forward feed standby
00 to 50 (in units of 0.1 mm, in steps of 0.5 mm) ^(*)
- l: Head-up operation in the cut issue mode, or the use of the rewinder in the batch issue mode.
- 0: OFF (Head-up operation is not performed/the rewinder is not used.)
 - 1: ON (Head-up operation is performed/the rewinder is used.)
- m: Ribbon saving system
- 0: OFF (Not used)
 - 1: ON (Head lever position is "TAG")
 - 2: ON (Head lever position is "LABEL")
- n: Type of control code
- 0: Automatic selection
 - 1: ESC, LF, NUL mode
 - 2: {, |, } mode
 - 3: Any set code mode

- oo: 1st byte code of the control code ^{(*)2}
 "00" to "FF" (Specify the hex code in 2 bytes of ASCII code.) ^{(*)3}
- pp: 2nd byte code of the control code ^{(*)2}
 "00" to "FF" (Specify the hex code in 2 bytes of ASCII code.) ^{(*)3}
- qq: 3rd byte code of the control code ^{(*)2}
 "00" to "FF" (Specify the hex code in 2 bytes of ASCII code.) ^{(*)3}
- r: Peel-off wait status selection
 0: OFF (No peel-off wait status selection)
 1: ON (Peel-off wait status selection)
- s: [FEED] key function
 0: FEED: Feeds one label.
 1: PRINT: Prints data of the image buffer on one label.
- t: Kanji code selection
 0: TYPE1
 1: TYPE2
- uu: Euro code setting
 "20" to "FF" (Specify the hex code in 2 bytes of ASCII code) ^{(*)3}
- v: Automatic head broken dots check
 0: OFF (When the power is turned on, the broken dots check is not automatically performed.)
 1: ON (When the power is turned on, the broken dots check is automatically performed.)
- w: Centronics ACK/BUSY timing setting
 0: TYPE1
 1: TYPE2
- x: Web printer function setting
 0: OFF (Web printer function is disabled.)
 1: ON (Web printer function is enabled.)
- y: Reset process when the nInit signal is ON
 0: OFF (Reset process is not performed.)
 1: ON (Reset process is performed.)
- z: Ribbon near end detection setting
 0: Not detected.
 1: Detected when the remaining length of the ribbon is 30 m.
 2: Detected when the remaining length of the ribbon is 70 m.
- A: Expansion I/O operation mode setting
 0: Standard mode
 1: In-line mode
- B: Centronics operation mode setting
 0: SPP (Compatibility mode)
 1: ECP (ECP mode)

- C: Plug-and-play operation mode setting
 - 0: OFF (Plug-and-play operation is disabled.)
 - 1: ON (Plug-and-play operation is enabled.)
- D: Label end/ribbon end process setting
 - 0: TYPE1 (When the label end state is detected, the printer stops even if it is printing a label.)
 - 1: TYPE2 (When the label end state is detected, the printer stops after it completes printing a label.)
- E: Pre-peel-off process setting
 - 0: OFF (The pre-peel-off process is not performed.)
 - 1: ON (The pre-peel-off process is performed.)
- F: Back feed speed setting
 - 0: 3 ips
 - 1: 2 ips
- G: Installed solenoid type setting
 - 0: TYPE 1 (TDS-12C)
 - 1: TYPE 2 (TDS-16A: Stronger pull force type)
- H: MaxiCode specification setting
 - 0: TYPE1 (Compatible with the current version)
 - 1: TYPE2 (Special specification)
- I: Forward feed standby action
 - 0: Mode 1
 - 1: Mode 2
- J: Print head type setting
 - 0: V1 type (B-SX4T: TPH104R2, B-SX5T: TPH128R4)
 - 1: V2 type (B-SX4T: TPH104R7, B-SX5T: TPH128R5)
- K: XML specification setting (Supported by V4.4A or greater)
 - 0: STD
 - 1: ORACLE

Explanation

- (1) This command is not executed until the printer enters an idle state.
- (2) With some exceptions, the parameters set by this command take effect when the power is turned on or the printer is reset.
- *1: The value can be set in units of 0.1 mm. However, the value which is actually set on the printer is in units of 0.5 mm. When a value from 0.0 mm to 0.4 mm is set, it is actually set on the printer as 0.0 mm. Also when a value from 0.5 mm to 0.9 mm is set, it is actually set on the printer as 0.5 mm. This fine adjustment value is set only when parameter "i" (Forward feed standby after an issue) is set to "1" (Performed). If it is set to "0" (Not performed), this value is discarded.
- *2 This fine adjustment value is set only when parameter "n" (Type of the control code) is set to "3" (Any set code mode). If it is set to any value other than "3", this value is discarded.
- *3 To specify the hex code to be set in 2 bytes of ASCII code as shown below:
 - Example 1: To set 36H: "36" (33H, 36H)
 - Example 2: To set 42H: "42" (34H, 32H)
 - Example 3: To set FFH: "FF" (46H, 46H)

6.4.2 FINE ADJUSTMENT VALUE SET COMMAND [ESC] Z2; 2

Function	Sets various fine adjustment values on the printer.
Format	[ESC] Z2; 2, abbbccddeffghhhijklmnnoppqrr [LF] [NUL]
Term	<p>a: Indicates the direction, forward or backward, in which a feed length fine adjustment is to be made. +: Backward -: Forward</p> <p>bbb: Feed length fine adjustment value 000 to 500 (in units of 0.1 mm, in steps of 0.5 mm) ^(*)</p> <p>c: Indicates the direction, forward or backward, in which a cut position (or strip position) fine adjustment is to be made. +: Backward -: Forward</p> <p>ddd: Fine adjustment value for the cut position (or strip position) 000 to 500 (in units of 0.1 mm, in steps of 0.5 mm) ^(*)</p> <p>e: Indicates whether the back feed is to be increased or decreased. +: Increase -: Decrease</p> <p>ff: Back feed length fine adjustment value 00 to 95 (in units of 0.1 mm, in steps of 0.5 mm) ^(*)</p> <p>g: Indicates the direction, positive or negative, in which the X-coordinate fine adjustment is to be made. +: Positive direction -: Negative direction</p> <p>hhh: X-coordinate fine adjustment value 000 to 995 (in units of 0.1 mm, in steps of 0.5 mm) ^(*)</p> <p>i: Indicates whether to increase or decrease the density in the thermal transfer print mode. +: Increase (darker) -: Decrease (lighter)</p> <p>jj: Print density fine adjustment value (for the thermal transfer print mode) 00 to 10 (in units of 1 step)</p> <p>k: Indicates whether to increase or decrease the density in the direct thermal print mode. +: Increase (darker) -: Decrease (lighter)</p> <p>ll: Print density fine adjustment value (for the direct thermal print mode) 00 to 10 (in units of 1 step)</p> <p>m: Fine adjustment direction for the ribbon rewind motor voltage -: Fixed as Negative (The voltage is lowered.)</p> <p>nn: Fine adjustment value for the ribbon rewind motor voltage 00 to 15 (in units of 1 step)</p>

- o: Fine adjustment direction for the ribbon back tension motor voltage
-: Negative (The voltage is lowered.)
- pp: Fine adjustment value for the ribbon back tension motor voltage
00 to 15 (in units of 1 step)
- qq: Reflective sensor manual threshold fine adjustment value
00 to 40 (in units of 0.1 V)
- rr: Transmissive sensor manual threshold fine adjustment value
00 to 40 (in units of 0.1 V)

Explanation

- (1) This command is not executed until the printer enters an idle state.
 - (2) With some exceptions, the parameters set by this command take effect when the power is turned on or the printer is reset.
- *1: The value can be set in units of 0.1 mm. However, the value which is actually set on the printer is in units of 0.5 mm. When a value from 0.0 mm to 0.4 mm is set, it is actually set on the printer as 0.0 mm. Also when a value from 0.5 mm to 0.9 mm is set, it is actually set on the printer as 0.5 mm.

6.4.3 RFID PARAMETER SET COMMAND

[ESC] Z2; 3

Function	Sets RFID related parameters on the printer.
Format	[ESC] Z2; 3, abbcdddeeffggghijjkkklm [LF] [NUL]
Term	<p>a: RFID module type selection</p> <ul style="list-style-type: none">0: Not installed.1: H1 (B-9704-RFID-H1-QM)2: U1 (B-9704-RFID-U1-US/EU(-R))3: H2 (B-SX704-RFID-H2)4: U2 (B-SX704-RFID-U2) <p>bb: Tag type</p> <ul style="list-style-type: none">00: None11: I-Code12: Tag-it13: C22014: ISO1569315: C21016: C24017: C32021: EPC Class 022: EPC Class 123: ISO 18000-6B24: EPC Class 1 Generation 2 <p>c: RFID error tag detection</p> <ul style="list-style-type: none">0: Not detected.1: Detected. <p>ddd: Max. number of RFID issue retries</p> <p>000 to 255</p> <p>eee: Max. number of RFID read retries</p> <p>000 to 255</p> <p>ff: RFID read retry time-out</p> <p>00 to 99 (In units of 0.1 sec.: 0.0 sec. to 9.9 sec.)</p> <p>ggg: Max. number of RFID write retries</p> <p>000 to 255</p> <p>hh: RFID write retry time-out</p> <p>00 to 99 (In units of 0.1 sec.: 0.0 sec. to 9.9 sec.)</p> <p>i: Feed direction of adjustment for retry</p> <ul style="list-style-type: none">+: Backward-: Forward <p>jj: Feed amount of adjustment for retry</p> <p>00 to 99 (In units of 1 mm: 0 mm to 99 mm)</p> <p>Only the value of -3 mm or less, or +3 mm or more becomes effective.</p> <p>kkk: RFID wireless power level</p> <p>000 to 255</p>

ll: RFID AGC threshold setting
00 to 15

m: RFID channel setting

0: AUTO

1: 2CH

2: 3CH

3: 4CH

4: 5CH

5: 6CH

6: 7CH

7: 8CH

Explanation

- (1) This command is not executed until the printer enters an idle state.
- (2) With some exceptions, the parameters set by this command take effect when the power is turned on or the printer is reset.

6.4.4 BATCH RESET COMMAND [ESC] Z0^(zero)

Function	Resets the printer.
Format	[ESC] Z0 [LF] [NUL]
Explanation	<ul style="list-style-type: none">• This command is not executed until the printer enters an idle state.• Some values in the Parameter Set Command ([ESC] Z2;1) and the Fine Adjustment Value Set Command ([ESC] Z2;2), will take effect when the printer is initialized. This command should be sent after the Parameter Set Command ([ESC] Z2;1) or Fine Adjustment Value Set Command ([ESC] Z2;2) is sent.

6.5 EXPLANATION OF THE RFID RELATED COMMANDS

6.5.1 RFID TAG POSITION ADJUSTMENT COMMAND

[ESC] @003

Function	Sets the feed amount to adjust the RFID tag position before writing data onto it. If the RFID tag is not positioned just above the RFID antenna when the paper is at the print start position, the printer automatically feeds the paper forward or backward by the specified amount to write data onto the RFID tag prior to printing.
Format	[ESC] @003; abbbb [LF] [NUL]
Term	a: Feed direction +: Backward -: Forward bbbb: Feed amount 0000 to 9999 (In units of 0.1 mm)
Explanation	(1) The printer automatically feeds paper forward or backward before writing data onto the RFID tag as specified in this command. After that, the printer returns the paper to the print start position for printing. (2) Only the value of -30 or less, or +30 or more becomes effective. (3) When the head up function has been enabled, it will be performed when the feed amount is set to -50 or less, or +50 or more . (4) Transmitting the Image Buffer Clear Command clears the settings of this command. (5) This command is ignored for on-the-fly issues.

6.5.2 RFID TAG READ COMMAND

[ESC] WF

Function	Reads the data stored on the RFID tag which is positioned just above the antenna.
Format	[ESC] WF (; Naaaa) (, Abbb) (, Tcc) (, Id) (, Jeeeeeeee) [LF] [NUL]
Term	<p>Naaaa: Number of bytes to be read (Omissible) 0001 to 4096</p> <p>Abbb: Address of data to be read 000 to 999 The address where reading the RFID tag is started is specified. This parameter is effective for the ISO18000-6B tag only. When omitted, the value will be set to 18.</p> <p>Tcc: Type of tag 00: None 11: I-Code 12: Tag-it 13: C220 14: ISO15693 15: C210 16: C240 17: C320 21: EPC Class 0 22: EPC Class 1 23: ISO18000-6B 24: EPC Class 1 Generation 2 Designates the type of RFID tag from which data is to be read. When omitted, the tag type set in system mode will be designated. In accordance with the tag type designated by this setting, the tag type set in system mode changes. When "00: NONE" is designated, the backed up tag type will be set, and the system mode setting will not be changed.</p> <p>Id: RFID read mode (Omissible) 1: Only user data is read. 2: Only tag ID is read. 3: Both tag ID and user data are read. When omitted, only user data will be read.</p> <p>Jeeeeeeee: Access to the password-protected tags (Omissible) Fixed to 8-digit hexadecimal number 00000000 to FFFFFFFF Accesses the password-protected tags. This parameter is effective only for the EPC Class 1 Generation 2 tag type.</p>

Explanation

- (1) The parameter, "Number of bytes to be read", is effective only when RFID read mode is set to 1 or 3, as this parameter is intended for reading user data. When reading tag ID, this parameter is ignored.
- (2) When the value exceeding the maximum number of bytes storable in a tag is designated for "Number of bytes to be read", a read error results.
- (3) When the number of bytes to be read is omitted, the user data and the ID bytes of the specified data bytes will be returned in accordance with the tag types, as shown in the table below.

Tag type	Number of user data bytes
EPC Class 0	8 bytes
EPC Class 1	8 bytes
Tag-it	32 bytes
I-Code	44 bytes
C220	9 bytes
C320	32 bytes
ISO15693	32 bytes
C210	0 bytes
C240	224 bytes
ISO18000-6B	32 bytes

Tag type	Number of ID bytes
EPC Class 0	12 bytes
EPC Class 1	8 bytes or 12 bytes
Tag-it	4 bytes
I-Code	8 bytes
C220	5 bytes
ISO15693	8 bytes
C210	8 bytes
C240	8 bytes
ISO18000-6B	8 bytes
EPC Class 1 Generation 2	8 bytes or 12 bytes

Supplemental explanation of parameter "I"

When Gen2 tag is used, options for the parameter "I" are as follows:

- I1: TID & User area data
- I2: EPC data
- I3: EPC data + TID & User area data

As the readability of the TID & User area differs depending on the tag manufacturers, refer to the memory map of each tag.

Example)

- In the case of OMRON's Gen2 tag
4-byte TID area is readable, and the user area is read/write protected.
- In the case of HITACHI's Gen2 tag (Hibiki)
8-byte TID area is readable/writable and 30-byte user area is readable/writable.

(4) The format of information to be returned to the host is as follows.

SOH	01H	Start of the status block
STX	02H	
"F"	46H	
Tag type	30H	30H30H: Reading failed. 31H31H: I-Code 31H32H: Tag-it 31H33H: C220 31H34H: ISO15693
	30H	31H35H: C210 31H36H: C240 31H37H: C320 32H31H: EPC Class 0 32H32H: EPC Class 1 32H33H: ISO18000-6B 32H34H: EPC Class 1 Generation 2
Data	---	Tag data (0 bytes to 9999 bytes)
ETX	03H	End of the status block
EOT	04H	
CR	0DH	
LF	0AH	

Example

Examples of the status to be returned are shown below. (The number of bytes to be read is omitted.)

[When a reading failed.]

Header		"F"	Tag type		Footer			
01H	02H	46H	30H	30H	03H	04H	0DH	0AH

Reading has failed.

[When a reading succeeded. (When RFID read mode=1 or omitted.)]

Header		"F"	Tag type		User data (32 bytes)								Footer			
01H	02H	46H	32H	33H	41H	42H	43H	xxH	xxH	44H	45H	46H	03H	04H	0DH	0AH

Tag type: ISO18000-6B
Read data "ABC...DEF"

[When a reading succeeded. (When RFID read mode=2.)]

Header		"F"	Tag type		Tag ID (8 bytes)								Footer			
01H	02H	46H	32H	33H	31H	32H	33H	34H	35H	36H	37H	38H	03H	04H	0DH	0AH

Tag type: ISO18000-6B
Read data "12345678"

[When a reading succeeded. (When RFID read mode=3.)]

Header		"F"	Tag type		Tag ID + User data (8 bytes + 32 bytes)								Footer			
01H	02H	46H	32H	32H	31H	32H	xxH	xxH	xxH	44H	45H	46H	03H	04H	0DH	0AH

Tag type: ISO18000-6B
Read data "123...678ABC...DEF"

6.5.3 RFID VOID PATTERN PRINT COMMAND

[ESC] @006

Function	Prints the void pattern to indicate an RFID tag error.
Format	[ESC] @006 [LF] [NUL]
Explanation	<ol style="list-style-type: none">(1) The void patten is printed according to the currently set label size.(2) After the void pattern is printed, the print data image is still retained.(3) This void pattern is printed when data cannot be written onto the RIFD tag properly due to breakage of RFID chip or some other reasons. The void pattern visually indicates that the RFID tag is faulty.(4) Usually, the void pattern is automatically printed if writing data onto the RFID tag results in an error, therefore, this command does not need to be transmitted. This command is intended to be used if writing data onto the RFID tag failed while the BASIC interpreter or the Pass Through Command is used and the RFID module is manually controlled to issue RFID labels.(5) The paper printed by this command is cut one by one.(6) The status indicating the end of the void pattern printing caused by this command is 60 (end of the void pattern printing).(7) Even when an image buffer clear command is sent after this command, void pattern image is not cleared and the printer prints the void pattern.

6.5.4 RFID DATA WRITE COMMAND

[ESC] @012

Function	Writes a specified data onto an RFID tag. No printing is performed. The result of a data write is notified by returning a detailed status.
Format	[ESC]@012; a (,Abbb) (,Mc) (,Pd) (,Fe) (,Tff) (,Dgg) (,Gh) (,Riiiiiii) (,kjjjjjjj) (,Lkk) (,Jlllllll) (,Vm) (,Bnn) (=ooo-----ooo) [LF] [NUL]
Term	<p>a: Data write parameter w: Data is written onto an RFID tag.</p> <p>Abbb: Address where the data is written (Omissible) 000 to 999 Designates the address where data starts to be written. When omitted, this parameter will be set to 18 for ISO18000-6B tag, or 0 for other tag types.</p> <p>Mc: Format of U-Code V1.19 (Omissible) 0: SGTIN 96 format 1: SSCC96 format 2: (Reserved) When the format of U-Code V1.19 is designated, the specified address, where the data is written, will become invalid. This parameter is effective only when the tag type is ISO18000-6B. When omitted, the U-Code V1.19 format is not used. When 2: (Reserved) is selected, operations are not guaranteed.</p> <p>Pd: Partition number (Omissible) 0 to 6 This parameter is effective only when U-Code V1.19 or EPC format is designated. When omitted, 5 will be set.</p> <p>Fe: Filter number (Omissible) 0 to 7 This parameter is effective only when U-Code V1.19 or EPC format is designated. When omitted, 0 will be set.</p> <p>Tff: Tag type (Omissible) 00: None 11: I-Code 12: Tag-it 13: C220 14: ISO15693 15: C210 16: C240 17: C320 21: EPC Class 0 22: EPC Class 1 23: ISO 18000-6B 24: EPC Class 1 Generation 2 Designates the type of RFID tag onto which data is to be written. When omitted, the tag type set in the system mode will be designated. In accordance with the tag type designated by this setting, the tag type set in the system mode changes. When "00: NONE" is designated, the backed up tag type will be designated, and the system mode setting will not be changed.</p>

Dgg: EPC format (Omissible)
 00: No format (When omitted)
 10: GID-96
 11: SGTIN-64
 12: SGTIN-96
 13: SSCC-64
 14: SSCC-96
 15: SGLN-64
 16: SGLN-96
 17: GRAI-64
 18: GRAI-96
 19: GIAI-64
 20: GIAI-96
 21: DoD-64
 22: DoD-96

Gh: Data type (Omissible)
 0: No conversion of data (Default)
 1: Conversion to binary
 2: Conversion to hexadecimal

Riiiiiii: Access password setting (Omissible)
 Fixed to 8-digit hexadecimal number
 00000000 to FFFFFFFF
 Sets a password to access tags.
 This parameter is effective only for EPC Class 1 Generation 2 tag type.

Kjjjjjjj: Kill password setting (Omissible)
 Fixed to 8-digit hexadecimal number
 00000000 to FFFFFFFF
 Sets a kill password for tags.
 This parameter is effective only for EPC Class 1 Generation 2 tag type.

Lkk: Lock/unlock setting (Omissible)

	Kill password	Access password	EPC code	TID	User data
00	Unlocked	Unlocked	Unlocked	Unlocked	Unlocked
01	Locked	Unlocked	Unlocked	Unlocked	Unlocked
02	Unlocked	Locked	Unlocked	Unlocked	Unlocked
03	Locked	Locked	Unlocked	Unlocked	Unlocked
04	Unlocked	Unlocked	Locked	Unlocked	Unlocked
05	Locked	Unlocked	Locked	Unlocked	Unlocked
06	Unlocked	Locked	Locked	Unlocked	Unlocked
07	Locked	Locked	Locked	Unlocked	Unlocked
08	Unlocked	Unlocked	Unlocked	Locked	Unlocked
09	Locked	Unlocked	Unlocked	Locked	Unlocked
10	Unlocked	Locked	Unlocked	Locked	Unlocked
11	Locked	Locked	Unlocked	Locked	Unlocked
12	Unlocked	Unlocked	Locked	Locked	Unlocked
13	Locked	Unlocked	Locked	Locked	Unlocked
14	Unlocked	Locked	Locked	Locked	Unlocked
15	Locked	Locked	Locked	Locked	Unlocked
16	Unlocked	Unlocked	Unlocked	Unlocked	Locked
17	Locked	Unlocked	Unlocked	Unlocked	Locked
18	Unlocked	Locked	Unlocked	Unlocked	Locked
19	Locked	Locked	Unlocked	Unlocked	Locked
20	Unlocked	Unlocked	Locked	Unlocked	Locked
21	Locked	Unlocked	Locked	Unlocked	Locked
22	Unlocked	Locked	Locked	Unlocked	Locked
23	Locked	Locked	Locked	Unlocked	Locked
24	Unlocked	Unlocked	Unlocked	Locked	Locked

25	Locked	Unlocked	Unlocked	Locked	Locked
26	Unlocked	Locked	Unlocked	Locked	Locked
27	Locked	Locked	Unlocked	Locked	Locked
28	Unlocked	Unlocked	Locked	Locked	Locked
29	Locked	Unlocked	Locked	Locked	Locked
30	Unlocked	Locked	Locked	Locked	Locked
31	Locked	Locked	Locked	Locked	Locked
32	Unlocked	Unlocked	Unlocked	Unlocked	Unlocked
33	Permanent lock	Unlocked	Unlocked	Unlocked	Unlocked
34	Unlocked	Permanent lock	Unlocked	Unlocked	Unlocked
35	Permanent lock	Permanent lock	Unlocked	Unlocked	Unlocked
36	Unlocked	Unlocked	Permanent lock	Unlocked	Unlocked
37	Permanent lock	Unlocked	Permanent lock	Unlocked	Unlocked
38	Unlocked	Permanent lock	Permanent lock	Unlocked	Unlocked
39	Permanent lock	Permanent lock	Permanent lock	Unlocked	Unlocked
40	Unlocked	Unlocked	Unlocked	Permanent lock	Unlocked
41	Permanent lock	Unlocked	Unlocked	Permanent lock	Unlocked
42	Unlocked	Permanent lock	Unlocked	Permanent lock	Unlocked
43	Permanent lock	Permanent lock	Unlocked	Permanent lock	Unlocked
44	Unlocked	Unlocked	Permanent lock	Permanent lock	Unlocked
45	Permanent lock	Unlocked	Permanent lock	Permanent lock	Unlocked
46	Unlocked	Permanent lock	Permanent lock	Permanent lock	Unlocked
47	Permanent lock	Permanent lock	Permanent lock	Permanent lock	Unlocked
48	Unlocked	Unlocked	Unlocked	Unlocked	Permanent lock
49	Permanent lock	Unlocked	Unlocked	Unlocked	Permanent lock
50	Unlocked	Permanent lock	Unlocked	Unlocked	Permanent lock
51	Permanent lock	Permanent lock	Unlocked	Unlocked	Permanent lock
52	Unlocked	Unlocked	Permanent lock	Unlocked	Permanent lock
53	Permanent lock	Unlocked	Permanent lock	Unlocked	Permanent lock
54	Unlocked	Permanent lock	Permanent lock	Unlocked	Permanent lock
55	Permanent lock	Permanent lock	Permanent lock	Unlocked	Permanent lock
56	Unlocked	Unlocked	Unlocked	Permanent lock	Permanent lock
57	Permanent lock	Unlocked	Unlocked	Permanent lock	Permanent lock
58	Unlocked	Permanent lock	Unlocked	Permanent lock	Permanent lock
59	Permanent lock	Permanent lock	Unlocked	Permanent lock	Permanent lock
60	Unlocked	Unlocked	Permanent lock	Permanent lock	Permanent lock
61	Permanent lock	Unlocked	Permanent lock	Permanent lock	Permanent lock
62	Unlocked	Permanent lock	Permanent lock	Permanent lock	Permanent lock
63	Permanent lock	Permanent lock	Permanent lock	Permanent lock	Permanent lock

Designates the areas to be locked. When omitted, no areas are locked.

This parameter is effective only for EPC Class 1 Generation 2 tag type.

JIIIIIII: Access to the password-protected tags (Omissible)

Fixed to 8-digit hexadecimal number

00000000 to FFFFFFFF

Accesses the password-protected tags.

This parameter is effective only for EPC Class1 Generation 2 tag type.

Vm: Write data verify designation (Omissible)

0: Verification disabled (Omissible)

1: Verification enabled

This parameter verifies if data has been written successfully. Select "1" (Verification enabled) for tags which may generate a phenomenon that the written data may not be the same as actual data even when an issue has successfully completed. When "1" is selected, it takes more time than when "0" (Verification disabled) is selected.

Bnn: Designates the area where the data is written (Omissible)
 00: Blank0 (Reserved area)
 01: Blank1 (EPC area) (When omitted)
 02: Blank2 (TID area)
 03: Blank3 (User area)
 This parameter is effective only for EPC Class1 Generation 2 tag type.
 When a format is designated, this parameter is ignored.

uvvvvvvvvv: Increment/Decrement
 (Omissible. When omitted, incrementing/decrementing is not performed.)
 u: Indicates whether to increment or decrement
 +: Increment
 -: Decrement
 vvvvvvvvv: Skip value (10 digits)
 0000000000 to 9999999999

ooo---ooo: Print data string (Omissible)
 Max. 512 digits, but the number of digits to be written is different depending on the tag types.

The result of a data write is returned in the following format.

SOH	01H	Indicates the start of the status block
STX	02H	
Status	30H	36H33H: Writing data succeeded. ("63")
	30H	36H34H: Writing data failed. ("64")
	35H	Fixed to 5 (RFID status)
Remaining count	30H	Remaining issue count (0000 to 9999)
	30H	
	30H	
	30H	
ETX	03H	Indicates the end of the status block.
EOT	04H	
CR	0DH	
LF	0AH	

7. CONTROL CODE SELECTION

(1) Automatic Selection

This printer automatically selects [ESC] (1BH), [LF] (0AH), [NUL] (00H) or {(7BH), | (7CH), } (7DH) as an interface command control code. After the power is turned on, the program checks the data from the host for [ESC] and { and assumes the data whichever has been sent first to be a control code.

For example, if [ESC] is sent first after the power is turned on, [ESC], [LF], [NUL] becomes a control code, and if { is sent first, { . | . } becomes a control code. Control code selection is made for every command. If the first command is [ESC] ~ [LF] [NUL], followed by [ESC], the control code becomes [ESC], [LF], [NUL], and if it is followed by { , the control code for the next command becomes { . | . }. When { . | . } is a control code, the data of 00H to 1FH in { ~ | } is ignored. However, the data of 00H to 1FH becomes valid while processing the Graphic Command or the Bit Map Writable Character Command in hexadecimal mode. When { . | . } is the control code, { . | . } cannot be used in the data of the Data Command or the Message Display Command.

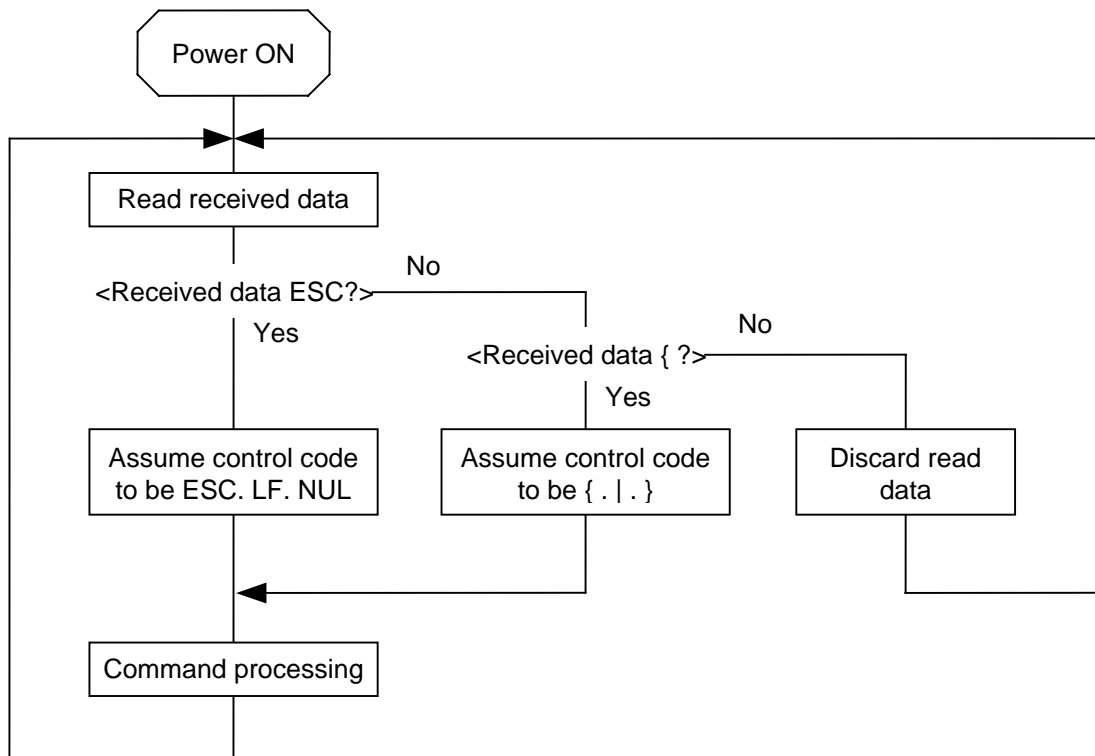

(2) Manual Selection (ESC. LF. NUL)

The control code of the command is [ESC] (1BH), [LF] (0AH), [NUL] (00H), and the control code selection is not performed.

(3) Manual Selection ({ . | . })

The control code of the command is {(7BH), | (7CH), } (7DH), and the control code selection is not performed. Data of 00H to 1FH is ignored and discarded in this mode. However, data of 00H to 1FH becomes valid while processing the Graphic Command or the Bit Map Writable Character Command in hexadecimal mode. When { . | . } is used as the control code, { . | . } cannot be used in the data of the Data Command or the Message Display Command.

(4) Manual Selection (Any set code)

The control code of the command is the code set in the system mode, and the control code selection is not performed. The code used in each command should not be set as the control code.

In the Data Command or the Message Display Command, the code set as the control code cannot be used.

8. ERROR PROCESSING

If the printer detects any of the following errors, it will display the error message (LCD, LED), makes status response (serial interface, parallel interface), and stops its operation.

8.1 COMMUNICATION ERRORS

(1) Command Errors

An error results if a command length error, command transmission sequence error, command format error, or parameter designation error is found in analyzing the command. An error results if the Format Command of a field is not transmitted and its Data Command is transmitted. When attempting to call a PC Save Command of a save identifier which is not saved, an error results. An undefined command is not detected as an error, and data is discarded until [ESC] or [{} is received.

(2) Hardware Errors

An error results if a framing error or parity error is found during data reception when using the serial interface (RS-232C).

* At the moment when a command error or hardware error occurs, the printer shows the error message and makes status response before stopping. The Status Request Command and Reset Command only can be processed and other commands are not processed. When the printer is restored by the [RESTART] key, the printer enters the initial state which is obtained after the power is turned on.

8.2 ERRORS IN ISSUING OR FEEDING

(1) Paper Jam

① When the relation between the programmed label (or tag) pitch (A) and the label (or tag) pitch detected by the sensor (B) is not indicated by the following formula, an error will result:

$$(A) \times 50\% \leq (B) \leq (A) \times 150\%$$

- A paper jam has occurred during paper feed.
- The paper is not placed properly.
- The actual label does not match the type of the sensor.
- The sensor position is not aligned with the black mark.
- The actual label size does not meet the designated label length.
- No label-to-label gap is detected due to preprint.
- The sensor is not thoroughly adjusted.
(The sensor is not adjusted for the label to be used.)

② If the stripped label does not cover the strip sensor when printing or feeding is completed in the strip mode, an error will result.

(2) Cutter Error

• Rotary cutter

When the cutter does not move from the cutter home position 40 msec or more after the cutter solenoid is driven, an error will result.

The cutter moves from the home position, however, it does not return to the home position after 150 msec.

• Swing cutter

When the cutter home position sensor does not detect 1.5 sec or more after the cutter motor is driven, an error will result.

- A paper jam has occurred at the cutter. (The cutter does not return to the home position.)
- The cutter does not move from the home position.
- The cutter cover is open.

(3) Label End

Error processing differs depending on the setting of label end/ribbon end process in the system mode.

When TYP1 is selected. (default):

- ① When the transmissive sensor or the reflective sensor detects a continuous 3-mm long label end state, an error will result.
- ② When an issue, a feed, or an ejection is attempted in a printer stop state while the transmissive sensor or the reflective sensor detects the label end state, an error will result.

When TYP2 is selected. (effective only when the ribbon saving function is not used.):

- ① When the transmissive sensor or the reflective sensor detects a continuous 3-mm long label end state, the printer completes the printing of half-finished label, and then an error will result when the next label is at the home position.
- ② When an issue, a feed, or an ejection is attempted in a printer stop state while the transmissive sensor or the reflective sensor detects the label end state, an error will result.

(4) Ribbon End

Error processing differs depending on the setting of label end/ribbon end process in the system mode.

When TYP1 is selected. (default):

- ① With the ribbon being selected, when the ribbon end sensor detects a continuous 5-mm long ribbon end state, an error will result.
- ② With the ribbon being selected, when an issue, a feed, or an ejection is attempted in a printer stop state while the ribbon end sensor detects the ribbon end state, an error will result.

When TYP2 is selected. (effective only when the ribbon saving function is not used.)

- ① With the ribbon being selected, when the ribbon end sensor detects a continuous 5-mm long ribbon end state, the following process depends on the unfinished label length as follows.
 - When unfinished label length is 30 mm or more, an error results after the printer prints the label for 20 mm.
 - When unfinished label length is less than 30 mm, the printer completes the half-finished label and stops printing when the next label is at the home position.
- ② With the ribbon being selected, when an issue, a feed, or an ejection is attempted in a printer stop state while the ribbon end sensor detects the ribbon end state, an error will result.

(5) Head Open Error

- ① If the head open sensor detects the open state in 5 mm continuously, an error will result.
- ② If the head open sensor detects the open state when an issue, a feed, or an ejection is attempted in a printer stop state, an error will result.
- ③ If the head-up sensor detects the head-up state in 5 mm continuously, an error will result.
- ④ If the head-up sensor detects the head-up state when an issue, a feed, or an ejection is attempted in a printer stop state, an error will result.
However, the feeding by the [FEED] key on the printer and the issuing and feeding by the expansion I/O are not included.

(6) Thermal Head Error

- ① A broken dot error has occurred in the thermal head.
- ② An error has occurred in the thermal head driver.

(7) Thermal Head Excessive Temperature

- ① When the open-air temperature detection thermistor detects an excessively high temperature (61 °C or more), an error will result.
- ② When the thermal head temperature detection thermistor detects an excessively high temperature (80 °C or more), an error will result.
- ③ When the heat sink sensor detects an excessively high temperature (91 °C or more), an error will result.

(8) Ribbon Error

- ① When the ribbon rewind motor sensor and ribbon back tension motor sensor do not perform detection if twice the prescribed time has passed, an error will result.
 - An abnormal condition has occurred in the sensor for determining the torque for the ribbon motor.
 - A ribbon jam has occurred.
 - The ribbon has run out.
 - The ribbon has not been installed.

(9) Rewinder Overflow

- ① If the rewinder overflow sensor detects the overflow state in 5 mm continuously when the strip function or the built-in rewinder is specified, an error will result.
- ② If the overflow sensor detects an overflow state when an issue, a feed, or an ejection is attempted in a printer stop state after the strip function or the built-in rewinder is specified, an error will result.

* At the moment an error occurs, the printer shows the error message, makes a status response, and then stops. Only the Status Request Command and the Reset Command can be processed. Other commands are not processed. Restoration using the [RESTART] key is possible except in the case of a thermal head excessive temperature error. (The printer resumes printing a label at which the error had occurred.)

8.3 ERRORS IN WRITABLE CHARACTER AND PC COMMAND SAVE MODES

- (1) Write Error
 - An error has occurred in writing in flash memory for storage.
 - (2) Format Error
 - An erase error has occurred in formatting flash memory for storage.
 - (3) Memory Full
 - Storing is impossible because of the insufficient flash memory for storage.
- * At the moment when an error occurs, the printer shows the error message, makes status response, then stops. The Status Request Command and the Reset Command only can be processed and other commands are not processed. Restoration using the [RESTART] key is impossible.

8.4 SYSTEM ERRORS

- (1) Momentary Power Interruption Error
 - A momentary power interruption has occurred.
 - (2) Address error
 - A command has been fetched from an odd address.
 - Word data has been accessed from a place other than the boundary of the word data.
 - Long word data has been accessed from a place other than the boundary of the long word data.
 - (3) General invalid command exception
 - An undefined command in a place other than the delay slot has been decoded.
 - (4) Slot invalid exception
 - An undefined command in the delay slot has been decoded.
 - A command which rewrites the data in the delay slot has been decoded.
- * At the moment when an error occurs, the printer shows the error message, then stops. (None of the commands and key operations will be processed.)
- (5) EEPROM Error
 - The EEPROM for back-up cannot be read/written properly.

8.5 RESET PROCESSING

When the [RESTART] key is held down for more than 3 seconds during the error which can be cleared by the [RESTART] key and during a pause, the printer returns to the initial status which is obtained after the power is turned on.

8.6 RFID ERROR

(1) RFID Write Error

If writing data onto the RFID tag continuously failed for the maximum number of RFID write retries, an RFID write error will result. (The maximum number of RFID write retries can be set in the system mode.)

* When an error has occurred, the printer shows an error message, sends a status response, and then stops. Only the Status Request Command and the Reset Command can be processed. Other commands are not processed. Restoration using the [RESTART] key is possible. (The printer resumes printing the label at which the error had occurred.)

(2) RFID Error

If a problem has occurred when the printer communicates with the RFID module, an RFID error will result.

9. STATUS RESPONSE

9.1 FUNCTIONS

There are three kinds of status response functions.

- (1) Status transmission function at the end of a normal transmission and the occurrence of an error (auto status transmission)

This function is available for the RS-232C interface and for the mail function.

If the option for "status response" has been selected, the printer sends the status to the host computer when the printer performs a feed or completes an issue normally (For the batch/cut mode: after the designated number of labels is printed, For the strip mode: after one label is printed). In the online mode, the head up/down status is sent to the host computer.

When each error occurs, the status is sent to the host computer.

The remaining count in the status response indicates the remaining count of the batch currently being printed. No remaining count of the batch waiting to be printed is transmitted.

- (2) Status transmission function by status request (Status Request Command)

This function is available for the RS-232C, USB, Centronics interfaces, and socket communications.

Upon request to send status by the Status Request Command, the printer sends the latest status indicating its current state to the host computer, regardless of the option for "status response/no status response". The remaining count indicates the remaining count of the batch currently being printed. No remaining count of the batch waiting to be printed is transmitted. This command is not stored in the receive buffer and executed immediately when it is received.

- (3) Receive buffer free space status transmission function by status request (Receive Buffer Free Space Status Request Command)

This function is available for the RS-232C, USB, Centronics interfaces, and socket communications.

Upon request to send status by the Receive Buffer Free Space Status Request Command, the printer sends the latest status indicating its current state to the host computer, regardless of the option for "status response/no status response". The remaining count indicates the remaining count of the batch currently being printed. No remaining count of the batch waiting to be printed is transmitted. This command is not stored in the receive buffer and executed immediately when it is received.

- Peel-off wait status

The peel-off wait status (05H) returned by the Status Request Command depends on the system mode setting.

When the peel-off wait status is set to "OFF" in the system mode:

If the Status Request Command is sent when a label is on the strip shaft (for example, while idling, after feeding a label, after printing all labels), the printer returns (00H) to the host.

When the peel-off wait status is set to "ON" in the system mode:

If the Status Request Command is sent when a label is on the strip shaft (for example, while idling, after feeding a label, after printing all labels), the printer returns (05H) to the host.

If the Status Request Command is sent while a label is being printed or issued, the peel-off wait status (05H) is returned for both settings.

9.1.1 STATUS FORMAT

SOH	STX	Status			Remaining count				ETX	EOT	CR	LF
01H	02H	3XH	3XH	3XH	3XH	3XH	3XH	3XH	03H	04H	0DH	0AH

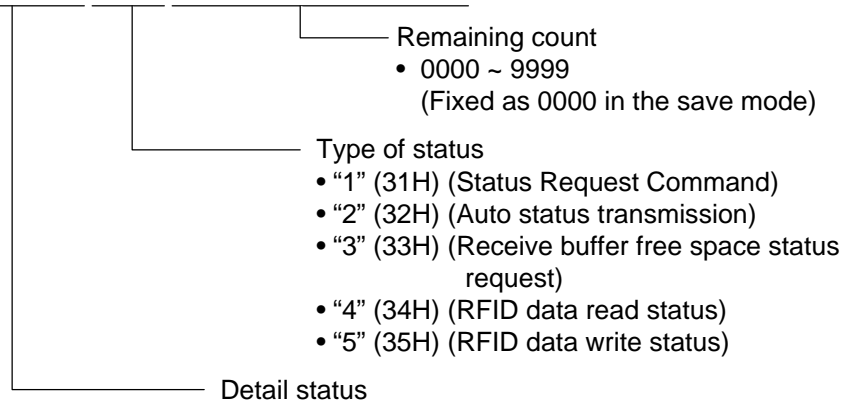

Status to be returned for the Receive Buffer Free Space Status Request Command

SOH	01H	Indicates the top of the status block
STX	02H	
Status	3XH	Printer status
	3XH	* Details are described above.
Status type	33H	Indicates the status for the ECP mode.
Remaining count	3XH	Remaining issue count * Details are described above.
	3XH	
	3XH	
	3XH	
Length	3XH	Total number of bytes of this status block.
	3XH	
Free space of receive buffer	3XH	Free space of the receive buffer “00000” (0 Kbyte) to “99999” (99999 Kbytes) However, the maximum value should be the total capacity of the receive buffer
	3XH	
	3XH	
	3XH	
Receive buffer Total capacity	3XH	Total capacity of the receive buffer “00000” (0 Kbyte) to “99999” (99999 Kbytes) However, the maximum value differs depending on the models.
	3XH	
	3XH	
	3XH	
CR	0DH	Indicates the end of the status block.
LF	0AH	

9.1.2 DETAIL STATUS

LCD Message of Upper Line (English)	Printer Status	Detail Status	
		Auto Status Transmission	Status Request Command
ON LINE	The head was closed with the head open.	00	00
HEAD OPEN	The head was opened in the online mode.	01	01
ON LINE	Operating (Analyzing command, drawing, printing, feeding)	–	02
PAUSE ****	In a pause state	–	04
ON LINE	Waiting for stripping	–	05
Display of error message (See NOTE 1.)	A command error was found in analyzing the command.	06	06
COMMS ERROR	A parity error or framing error occurred during communication by RS-232C	07	07
PAPER JAM ****	A paper jam occurred during a paper feed.	11	11
CUTTER ERROR****	An abnormal condition occurred at the cutter.	12	12
NO PAPER ****	The label has run out.	13	13
NO RIBBON ****	The ribbon has run out.	14	14
HEAD OPEN ****	An attempt was made to feed or issue with the head open (except the [FEED] key)	15	15
HEAD ERROR ****	A broken dot error has occurred in the thermal head.	17	17
EXCESS HEAD TEMP	The thermal head temperature has become excessively high.	18	18
RIBBON ERROR****	An abnormal condition occurred in the sensor for determining the torque for the ribbon motor.	21	21
REWIND FULL ****	An overflow error has occurred in the rewinder.	22	22
ON LINE	Ribbon near end state (Online)	–	27
PAUSE	Ribbon near end state (In a pause state)	–	28
ON LINE	Ribbon near end state (Operating)	–	29
ON LINE	A label issue has been completed normally.	40	–
ON LINE	A feed has been completed normally.	41	–
ON LINE	A head broken dots check has been completed normally.	00	–
SAVING ### &&&& ----- SAVING %%%%%%%%%	In writable character or PC command save mode	–	55
FLASH WRITE ERR.	An error has occurred in writing data into memory for storage.	50	50
FORMAT ERROR	An erase error has occurred in formatting memory for storage.	51	51
FLASH CARD FULL	Saving failed because of the insufficient capacity of memory for storage.	54	54

LCD Message of Upper Line (English)	Printer Status	Detail Status	
		Auto Status Transmission	Status Request Command
POWER FAILURE	A momentary power interruption has occurred.	—	—
INITIALIZING...	The memory card for storage is being initialized. (Initialization is carried out for a max. of approximately 15 seconds)		
EEPROM ERROR	An EEPROM for back up cannot be read/written properly.	—	—
SYSTEM ERROR	(a) A command has been fetched from an odd address. (b) Word data has been accessed from a place other than the boundary of the word data. (c) Long word data has been accessed from a place other than the boundary of the long word data. (d) An undefined command in a place other than the delay slot has been decoded. (e) An undefined command in the delay slot has been decoded. (f) A command which rewrites the data in the delay slot has been decoded.	—	—
-	A void pattern printing is completed. When data cannot be written onto the RFID tag properly, the printer prints the void pattern to indicate that this tag is faulty, and then, automatically retries according to the setting for the maximum number of RFID write retries. When the void pattern printing is completed, the printer sends this status.	60	---
RFID WRITE ERROR	When writing data onto the RFID tag continuously failed for the maximum number of RFID write retries, the printer enters an error state and sends this status.	61	61
RFID ERROR	When the printer cannot communicate with the RFID module, due to a failure of the RFID module or some other reasons, this error occurs.	62	62
-	Writing data onto an RFID tag succeeded. When a data write, performed by an RFID Data Write Command (@012), succeeded, this status is returned.	---	---
-	Writing data onto an RFID tag failed. When a data write, performed by an RFID Data Write Command (@012), failed, this status is returned.	---	---
INPUT PASSWORD	The printer is waiting for a password to be entered.	---	---
PASSWORD INVALID	Password entered was not correct consecutively for three times.	---	---

9.1.3 SUMMARY OF STATUS RESPONSE

Interface			Status transmission timing	Status size
RS-232C			Automatic status transmission	13 bytes
			Reception of [ESC] WS [LF] [NUL]	13 bytes
			Reception of [ESC] WB [LF] [NUL]	23 bytes
Centronics	System mode setting	SPP	Automatic status transmission	N/A
			Nibble mode negotiation immediately after [ESC] WS [LF] [NUL] is received	13 bytes
			Nibble mode negotiation immediately after [ESC] WB [LF] [NUL] is received	23 bytes
		ECP	Automatic status transmission	N/A
			Reverse request immediately after [ESC] WS [LF] [NUL] is received	13 bytes
			Reverse request immediately after [ESC] WB [LF] [NUL] is received	23 bytes
USB			Automatic status transmission	N/A
			Reception of [ESC] WS [LF] [NUL]	13 bytes
			Reception of [ESC] WB [LF] [NUL]	23 bytes
Socket communications			Automatic status transmission	13 bytes
			Reception of [ESC] WS [LF] [NUL]	13 bytes
			Reception of [ESC] WB [LF] [NUL]	23 bytes
Mail function			Automatic status transmission	13 bytes

9.2 PARALLEL INTERFACE SIGNALS

9.2.1 COMPATIBILITY MODE

LCD Messages of Upper Line (English)	Printer Status	Output Signal			
		Busy	Select	nFault	PError
ON LINE	In the online mode	L	H	H	L
ON LINE	In the online mode (communicating)	L, H	H	H	L
HEAD OPEN	The head was opened in the online mode.	H	L	L	L
PAUSE ****	In a pause state	H	L	L	L
ON LINE	Data was set from the host with the receive buffer full.	H	H	H	L
ON LINE	After data was sent from the host with the receive buffer full, some data is processed and room becomes available.	L	H	H	L
ON LINE	Initialize process in execution (After the power is turned on or the nInit signal is received)	H	H	H	L
Display of error command	A command error has occurred in analyzing the command.	H	L	L	L
PAPER JAM ****	A paper jam occurred during a paper feed.	H	L	L	L
CUTTER ERROR****	An abnormal condition occurred at the cutter.	H	L	L	L
NO PAPER ****	The label has run out.	H	L	L	H
NO RIBBON ****	The ribbon has run out.	H	L	L	H
HEAD OPEN ****	A feed or an issue was attempted with the head opened. (except the [FEED] key)	H	L	L	L
HEAD ERROR ****	A broken dot error has occurred in the thermal head.	H	L	L	L
EXCESS HEAD TEMP	The thermal head temperature has become excessively high.	H	L	L	L
RIBBON ERROR****	An abnormal condition occurred in the sensor for determining the torque for the ribbon motor.	H	L	L	L
REWIND FULL ****	An overflow error has occurred in the rewinder.	H	L	L	L
ON LINE	Ribbon near end state (Online)	L	H	H	L
PAUSE	Ribbon near end state (In a pause state)	H	L	L	L
ON LINE	Ribbon near end state (Operating)	L	H	H	L
SAVING ### &&&& _	In writable character or PC command save mode	L	H	H	L
SAVING %%%%%%%%%					
FLASH WRITE ERR.	An error has occurred in writing data into memory for storage.	H	L	L	L
FORMAT ERROR	An erase error has occurred in formatting memory for storage.	H	L	L	L
FLASH CARD FULL	Saving failed because of the insufficient capacity of memory for storage.	H	L	L	L
POWER FAILURE	A momentary power interruption has occurred.	H	L	L	L
INITIALIZING...	The memory card for storage is being initialized. (Initialization is carried out for a max. of approximately 15 seconds)				

LCD Messages of Upper Line (English)	Printer Status	Output Signal			
		Busy	Select	nFault	PError
EEPROM ERROR	An EEPROM for back-up cannot be read/written properly.	H	L	L	L
SYSTEM ERROR	(a) A command has been fetched from an odd address. (b) Word data has been accessed from a place other than the boundary of the word data. (c) Long word data has been accessed from a place other than the boundary of the long word data. (d) An undefined command in a place other than the delay slot has been decoded. (e) An undefined command in the delay slot has been decoded. (f) A command which rewrites the data in the delay slot has been decoded.	H	L	L	L
RFID WRITE ERROR	Writing data onto the RFID tag continuously failed for the maximum number of RFID write retries.	H	L	L	L
RFID ERROR	The printer cannot communicate with the RFID module.	H	L	L	L
INPUT PASSWORD	The printer is waiting for a password to be entered.	H	L	L	L
PASSWORD INVALID	Password entered was not correct consecutively for three times.	H	L	L	L

9.3 E-MAIL

The printer can notify the PC of the printer status by e-mail. The status to be notified by e-mail is the same as the status which is notified through the serial interface. For details, refer to the Network Specification (TAA-1401).

10. LCD MESSAGES AND LED INDICATIONS

The model and the firmware version are displayed on the lower line of the LCD.

No.	LCD Messages of Upper line (English)	LED Indication			Printer Status	Restoration by the [RESTART] key Yes/No	Acceptance of Status Request Reset Command Yes/No
		POWER	ON LINE	ERROR			
1	ON LINE	○	○	●	In the online mode	-	Yes
	ON LINE	○	⊙	●	In the online mode (Communicating)	-	Yes
2	HEAD OPEN	○	●	●	The head was opened in the online mode.	-	Yes
3	PAUSE ****	○	●	●	In a pause state	Yes	Yes
4	COMMS ERROR	○	●	○	A parity error or framing error has occurred during communication by RS-232C.	Yes	Yes
5	PAPER JAM ****	○	●	○	A paper jam occurred during paper feed.	Yes	Yes
6	CUTTER ERROR****	○	●	○	An abnormal condition occurred at the cutter.	Yes	Yes
7	NO PAPER ****	○	●	○	The label has run out.	Yes	Yes
8	NO RIBBON ****	○	●	○	The ribbon has run out.	Yes	Yes
9	HEAD OPEN ****	○	●	○	A feed or an issue was attempted with the head opened. (except the [FEED] key)	Yes	Yes
10	HEAD ERROR	○	●	○	A broken dot error has occurred in the thermal head.	Yes	Yes
11	EXCESS HEAD TEMP	○	●	○	The thermal head temperature has become excessively high.	No	Yes
12	RIBBON ERROR****	○	●	○	An abnormal condition occurred in the sensor for determining the torque for the ribbon motor.	Yes	Yes
13	REWIND FULL ****	○	●	○	An overflow error has occurred in the rewinder.	Yes	Yes
14	SAVING ### &&&& SAVING %%%%%%%%%	○	○	●	In writable character or PC command save mode	-	Yes
15	FLASH WRITE ERR.	○	●	○	An error has occurred in writing data into memory for storage (flash memory card, the ATA card, or flash ROM on the CPU board).	No	Yes
16	FORMAT ERROR	○	●	○	An erase error has occurred in formatting memory for storage (flash memory card, the ATA card, or flash ROM on the CPU board).	No	Yes
17	FLASH CARD FULL	○	●	○	Saving failed because of the insufficient capacity of memory for storage (flash memory card, the ATA card, or flash ROM on the CPU board).	No	Yes

No.	LCD Messages of Upper line (English)	LED Indication			Printer Status	Restoration by the [RESTART] key Yes/No	Acceptance of Status Request Reset Command Yes/No
		POWER	ON LINE	ERROR			
18	Display of error command (See NOTE 1.)	○	●	○	A command error has occurred in analyzing the command.	Yes	Yes
19	POWER FAILURE	○	●	○	A momentary power interruption has occurred.	No	No
20	INITIALIZING...	○	●	●	The memory card is being initialized. (Initialization is carried out for a max. of approximately 15 seconds)	—	—
21	EEPROM ERROR	○	●	○	An EEPROM for back-up cannot be read/written properly.	No	No
22	SYSTEM ERROR	○	●	○	When any abnormal operations as below are performed, a system error occurs. (a) Command fetch from an odd address (b) Access to the word data from a place other than the boundary of the word data (c) Access to the long word data from a place other than the boundary of the long word data (d) Access to the area of 80000000H to FFFFFFFFH in the logic space in the user mode. (e) Undefined command placed in other than the delay slot has been decoded. (f) Undefined command in the delay slot has been decoded. (g) Command to rewrite the delay slot has been decoded.	No	No
23	100BASE LAN INITIALIZING... (This is spread over the upper and lower lines)	○	●	●	The 100BASE LAN is being initialized. * When the B-9700-LAN-QM (built-in 10/100BASE Ethernet interface board) has been installed.	—	—
24	DHCP CLIENT INITIALIZING... (This is spread over the upper and lower lines)	○	●	●	The DHCP client is being initialized. * When the DHCP function is enabled.	—	—

No.	LCD Messages of Upper line (English)	LED Indication			Printer Status	Restoration by the [RESTART] key Yes/No	Acceptance of Status Request Reset Command Yes/No
		POWER	ON LINE	ERROR			
25	RFID WRITE ERROR	○	●	○	Writing data onto the RFID tag continuously failed for the maximum number of RFID write retries.	Yes	Yes
26	RFID ERROR	○	●	○	The printer cannot communicate with the RFID module.	Yes	Yes
27	INPUT PASSWORD	○	●	●	The printer is waiting for a password to be entered.	No	No
28	PASSWORD INVALID	○	●	●	Password entered was not correct consecutively for three times.	No	No

NOTE 1: When a command error is found in the command sent, 16 bytes of the command code of the error command are displayed on the upper line of the LCD. (However, [LF] and [NUL] are not displayed.)

[Example 1] [ESC] PC001; 0A00, 0300, 2, 2, A, 00, B [LF] [NUL]

Command error

LCD display

PC001;0A00,0300, B-SX4T v1.0A

[Example 2] [ESC] T20 G30 [LF] [NUL]

Command error

LCD display

T20G30 B-SX4T v1.0A

[Example 3] [ESC] XR; 0200, 0300, 0450, 1200, 1 [LF] [NUL]

Command error

LCD display

XR;0200,0300,045 B-SX4T v1.0A

NOTE 2: When the command error is displayed, “? (3FH)” is displayed for codes other than 20H to 7FH and A0H to DFH.

- NOTE 3:**
- : ON
 - ⊙: Blinking
 - : OFF
 - ****: Remaining number of labels to be printed □□□□ to 9999 (in units of 1 label/tag)
 - %%%%%%%%: Remaining memory capacity for ATA card 0 to 9999999 (in units of 1 K byte)
 - ###: Remaining memory capacity of PC save area of the flash memory card:
0 to 895 (in K bytes)
 - &&&&: Remaining memory capacity of writable character storage area for the flash memory card
0 to 3147 (in K bytes)

NOTE 4: If the ribbon near end detection setting is specified, the ERROR LED blinks slowly, while the printer is in a ribbon near end state and displays messages 1, 2, or 3.

11. LCD MESSAGES IN DIFFERENT LANGUAGES (UPPER LINE OF LCD)

No.	ENGLISH
1	ON LINE
2	HEAD OPEN
3	PAUSE ****
4	COMMS ERROR
5	PAPER JAM ****
6	CUTTER ERROR****
7	NO PAPER ****
8	NO RIBBON ****
9	HEAD OPEN ****
10	HEAD ERROR
11	EXCESS HEAD TEMP
12	RIBBON ERROR****
13	REWIND FULL ****
14	SAVING ### &&& ----- SAVING %%%%%%%%%
15	FLASH WRITE ERR.
16	FORMAT ERROR
17	FLASH CARD FULL
18	POWER FAILURE
19	INITIALIZING...
20	EEPROM ERROR
21	SYSTEM ERROR
22	RFID WRITE ERROR
23	RFID ERROR
24	INPUT PASSWORD
25	PASSWORD INVALID

No.	GERMAN
1	ON LINE
2	KOPF OFFEN
3	PAUSE ****
4	UEBERTR.-FEHLER
5	PAPIERSTAU ****
6	MESSERFEHL. ****
7	PAPIERENDE ****
8	FARBB.-ENDE ****
9	KOPF OFFEN ****
10	KOPF DEFEKT
11	KOPF UEBERHITZT
12	FB-FEHLER ****
13	AUFWI.VOLL ****
14	SP.-MOD ### &&&& ----- SP.-MOD %%%%%%%%%
15	FLASH FEHLER
16	FORMATFEHLER
17	FLASH ZU KLEIN
18	POWER FAILURE
19	INITIALIZING...
20	EEPROM ERROR
21	SYSTEM ERROR
22	RFID WRITE ERROR
23	RFID ERROR
24	INPUT PASSWORD
25	PASSWORD INVALID

No.	FRENCH
1	PRETE
2	TETE OUVERTE
3	PAUSE ****
4	ERR. COMMUNICAT.
5	PB. PAPIER ****
6	PB. CUTTER ****
7	FIN PAPIER ****
8	FIN RUBAN ****
9	TETE OUVERTE****
10	ERREUR TETE
11	TETE TROP CHAUDE
12	ERREUR RUBAN****
13	ERR.REMB. ****
14	MEM LIB ### &&&& ----- MEM LIB %%%%%%%%%
15	ERREUR MEM FLASH
16	ERREUR DE FORMAT
17	MEM INSUFFISANTE
18	POWER FAILURE
19	INITIALIZING...
20	EEPROM ERROR
21	SYSTEM ERROR
22	RFID WRITE ERROR
23	RFID ERROR
24	INPUT PASSWORD
25	PASSWORD INVALID

No.	DUTCH
1	IN LIJN
2	KOP OPEN
3	PAUZE ****
4	COMM. FOUT
5	PAPIER VAST ****
6	SNIJMES FOUT****
7	PAPIER OP ****
8	LINT OP ****
9	KOP OPEN ****
10	PRINTKOP DEFECT
11	TEMP. FOUT
12	LINT FOUT ****
13	OPROL VOL ****
14	MEM ### &&&& ----- MEM %%%%%%%%%
15	FLASH MEM FOUT
16	FORMAAT FOUT
17	GEHEUGEN VOL
18	POWER FAILURE
19	INITIALIZING...
20	EEPROM ERROR
21	SYSTEM ERROR
22	RFID WRITE ERROR
23	RFID ERROR
24	INPUT PASSWORD
25	PASSWORD INVALID

No.	SPANISH
1	ON LINE
2	CABEZAL ABIERTO
3	PAUSA ****
4	ERROR COMUNICACI
5	ATASCO PAPEL****
6	ERROR CORTAD****
7	SIN PAPEL ****
8	SIN CINTA ****
9	CABEZA ABIER****
10	ERROR DE CABEZAL
11	TEMP.CABEZA ALTA
12	ERROR CINTA ****
13	REBOBI.LLENO****
14	SALVAR ### &&&& ----- SALVAR %%%%%%%%%
15	ERROR ESCRITURA
16	ERROR DE FORMATO
17	MEMORIA INSUFICI
18	POWER FAILURE
19	INITIALIZING...
20	EEPROM ERROR
21	SYSTEM ERROR
22	RFID WRITE ERROR
23	RFID ERROR
24	INPUT PASSWORD
25	PASSWORD INVALID

No.	JAPANESE
1	
2	
3	
4	
5	
6	
7	
8	
9	
10	
11	
12	
13	
14	
15	
16	
17	
18	
19	
20	
21	
22	
23	
24	
25	

* Japanese messages are omitted here.

No.	Italian
1	PRONTA
2	TESTA APERTA
3	PAUSA *****
4	ERR. COMUNICAZ.
5	CARTA INCEP. *****
6	ERR. TAGL. *****
7	NO CARTA *****
8	NO NASTRO *****
9	TESTA APERTA*****
10	ERROR TESTA
11	TEMP. TESTA ALTA
12	ERR. NASTRO *****
13	RIAVV. PIENO *****
14	SALVA ### &&&& ----- SALVA %%%%%%%%%%
15	ERR. SCRITT. CARD
16	ERR. FORMATTAZ.
17	MEM. CARD PIENA
18	POWER FAILURE
19	INITIALIZING...
20	EEPROM ERROR
21	SYSTEM ERROR
22	RFID WRITE ERROR
23	RFID ERROR
24	INPUT PASSWORD
25	PASSWORD INVALID

12. CHARACTER CODE TABLE

The followings are the character code tables. However, the characters which can be printed are different according to the character type.

12.1 TIMES ROMAN, HELVETICA, LETTER GOTHIC, PRESTIGE ELITE, COURIER, GOTHIC725 BLACK

(Bit map font type: A, B, C, D, E, F, G, H, I, J, K, L, N, O, P, Q, R, q)

(1) PC-850

	0	1	2	3	4	5	6	7	8	9	A	B	C	D	E	F
0			0	@	P	`	p	Ç	É	á	€			ð	Ó	-
1			!	1	A	Q	a	q	ü	æ	í			Ð	ß	±
2			"	2	B	R	b	r	é	Æ	ó			Ê	Ô	=
3			#	3	C	S	c	s	â	ô	ú			Ë	Õ	¾
4			\$	4	D	T	d	t	ä	ö	ñ			È	ö	¶
5			%	5	E	U	e	u	à	ò	Ñ	Á		1	Õ	§
6			&	6	F	V	f	v	â	û	ª	Â	ã	í	µ	÷
7			'	7	G	W	g	w	ç	ù	º	À	Ã	î	þ	·
8			(8	H	X	h	x	ê	ÿ	¿	©		ï	þ	°
9)	9	I	Y	i	y	ë	Ö	®				Ú	´
A			*	:	J	Z	j	z	è	Ü	¬				Û	•
B			+	;	K	[k	{	ï	ø	½				Ü	¹
C			,	<	L	\	l		î	£	¼				Ý	³
D			-	=	M]	m	}	ì	Ø	¡	¢		!	Ý	²
E			.	>	N	^	n	~	Ä	x	«	¥		ì	'	■
F			/	?	O	_	o		Å	f	»		¤	'	'	

When Japanese message is selected in the system mode, code 5CH indicates "¥".

The Euro code (B0H) can be changed in the parameter setting in the system mode.

(2) PC-8

	0	1	2	3	4	5	6	7	8	9	A	B	C	D	E	F
0			0	@	P	`	p	Ç	É	á	€				α	≡
1			!	1	A	Q	a	q	ü	æ	í				β	±
2			"	2	B	R	b	r	é	Æ	ó				Γ	≥
3			#	3	C	S	c	s	â	ô	ú				π	≤
4			\$	4	D	T	d	t	ä	ö	ñ				Σ	∫
5			%	5	E	U	e	u	à	ò	Ñ				σ	∫
6			&	6	F	V	f	v	â	û	ª				μ	÷
7			'	7	G	W	g	w	ç	ù	º				τ	≈
8			(8	H	X	h	x	ê	ÿ	¿				Φ	°
9)	9	I	Y	i	y	ë	Ö	⌂				Θ	•
A			*	:	J	Z	j	z	è	Ü	¬				Ω	•
B			+	;	K	[k	{	ï	ø	½				δ	√
C			,	<	L	\	l		î	£	¼				∞	n
D			-	=	M]	m	}	ì	¥	¡				∅	2
E			.	>	N	^	n	~	Ä	Pt	«				ε	■
F			/	?	O	_	o		Å	∫	»				∩	

When Japanese message is selected in the system mode, code 5CH indicates "¥".

The Euro code (B0H) can be changed in the parameter setting in the system mode.

(3) PC-852

	0	1	2	3	4	5	6	7	8	9	A	B	C	D	E	F
0			0	@	P	`	p	Ç	É	á	€			Ó	-	
1		!	1	A	Q	a	q	ü		í			Đ	ß		
2		"	2	B	R	b	r	é		ó				Ô		
3		#	3	C	S	c	s	â	ô	ú			Ë			
4		\$	4	D	T	d	t	ä	ö							
5		%	5	E	U	e	u				Á					§
6		&	6	F	V	f	v				Â			Í		÷
7		'	7	G	W	g	w	ç						Î		¸
8		(8	H	X	h	x									°
9)	9	I	Y	i	y	ë	Ö					Ú		´
A		*	:	J	Z	j	z		Ü	¬						•
B		+	;	K	[k	{									
C		,	<	L	\	l		î							ý	
D		-	=	M]	m	}								ÿ	
E		.	>	N	^	n	~	Ä	x	«						■
F		/	?	O	_	o				»			α			

When Japanese message is selected in the system mode, code 5CH indicates “¥”.
The Euro code (B0H) can be changed in the parameter setting in the system mode.

(4) PC-857

	0	1	2	3	4	5	6	7	8	9	A	B	C	D	E	F
0			0	@	P	`	p	Ç	É	á	€		º	Ó	-	
1		!	1	A	Q	a	q	ü	æ	í			ª	ß	±	
2		"	2	B	R	b	r	é	Æ	ó			Ê	Ô		
3		#	3	C	S	c	s	â	ô	ú			Ë	Ò	¾	
4		\$	4	D	T	d	t	ä	ö	ñ			È	õ	¶	
5		%	5	E	U	e	u	à	ò	Ñ	Á			Ö	§	
6		&	6	F	V	f	v	ã	û		Â	ã	í	µ	÷	
7		'	7	G	W	g	w	ç	ù		À	Ã	î		¸	
8		(8	H	X	h	x	ê		¿	©			ï		°
9)	9	I	Y	i	y	ë	Ö	®				Ú		´
A		*	:	J	Z	j	z	è	Ü	¬				Û		•
B		+	;	K	[k	{	ï	ø	½				Ù		¹
C		,	<	L	\	l		î	£	¼				ì		³
D		-	=	M]	m	}		Ø	ı	¢			ı	ÿ	²
E		.	>	N	^	n	~	Ä		«	¥			ì		■
F		/	?	O	_	o		Å		»			α			

When Japanese message is selected in the system mode, code 5CH indicates “¥”.
The Euro code (B0H) can be changed in the parameter setting in the system mode.

(5) PC-851

	0	1	2	3	4	5	6	7	8	9	A	B	C	D	E	F
0			0	@	P	`	p	Ç				€				
1		!	1	A	Q	a	q	ü								±
2		"	2	B	R	b	r	é								
3		#	3	C	S	c	s	â	ô							
4		\$	4	D	T	d	t	ä	ö							
5		%	5	E	U	e	u	à								§
6		&	6	F	V	f	v		û							
7		'	7	G	W	g	w	ç	ù							•
8		(8	H	X	h	x	ê								°
9)	9	I	Y	i	y	ë	Ö							¨
A		*	:	J	Z	j	z	è	Ü							
B		+	;	K	[k	{	ï		½						
C		,	<	L	\	l		î	£							
D		-	=	M]	m	}									
E		.	>	N	^	n	~	Ä		«						■
F		/	?	O	_	o	⌘			»						

When Japanese message is selected in the system mode, code 5CH indicates “¥”.

The Euro code (B0H) can be changed in the parameter setting in the system mode.

(6) PC-855

	0	1	2	3	4	5	6	7	8	9	A	B	C	D	E	F
0			0	@	P	`	p					€				
1		!	1	A	Q	a	q									
2		"	2	B	R	b	r									
3		#	3	C	S	c	s									
4		\$	4	D	T	d	t									
5		%	5	E	U	e	u									
6		&	6	F	V	f	v									
7		'	7	G	W	g	w									
8		(8	H	X	h	x									
9)	9	I	Y	i	y									
A		*	:	J	Z	j	z									
B		+	;	K	[k	{									
C		,	<	L	\	l										
D		-	=	M]	m	}									§
E		.	>	N	^	n	~			«						■
F		/	?	O	_	o	⌘			»			α			

When Japanese message is selected in the system mode, code 5CH indicates “¥”.

The Euro code (B0H) can be changed in the parameter setting in the system mode.

(7) PC-1250

	0	1	2	3	4	5	6	7	8	9	A	B	C	D	E	F
0			0	@	P	`	p					€				
1		!	1	A	Q	a	q					±	Á		á	
2		"	2	B	R	b	r						Â		â	
3		#	3	C	S	c	s							Ó		ó
4		\$	4	D	T	d	t			¤	'	Ä	Ö	ä	ö	
5		%	5	E	U	e	u				μ					
6		&	6	F	V	f	v			¡	¶		Ö		ö	
7		'	7	G	W	g	w			§	·	Ç	x	ç	÷	
8		(8	H	X	h	x			"	,					
9)	9	I	Y	i	y			©			É		é	
A		*	:	J	Z	j	z							Ú		ú
B		+	;	K	[k	{			«	»	Ë			ë	
C		,	<	L	\	l				¬			Ü		ü	
D		-	=	M]	m	}						Í	Ý	í	ý
E		.	>	N	^	n	~			®			Î		î	
F		/	?	O	_	o	⌘							ß		

When Japanese message is selected in the system mode, code 5CH indicates “¥”.

The Euro code (B0H) can be changed in the parameter setting in the system mode.

(8) PC-1251

	0	1	2	3	4	5	6	7	8	9	A	B	C	D	E	F
0			0	@	P	`	p					€				
1		!	1	A	Q	a	q					±				
2		"	2	B	R	b	r									
3		#	3	C	S	c	s									
4		\$	4	D	T	d	t			¤						
5		%	5	E	U	e	u				μ					
6		&	6	F	V	f	v			¡	¶					
7		'	7	G	W	g	w			§	·					
8		(8	H	X	h	x									
9)	9	I	Y	i	y			©						
A		*	:	J	Z	j	z									
B		+	;	K	[k	{			«	»					
C		,	<	L	\	l				¬						
D		-	=	M]	m	}									
E		.	>	N	^	n	~			®						
F		/	?	O	_	o	⌘									

When Japanese message is selected in the system mode, code 5CH indicates “¥”.

The Euro code (B0H) can be changed in the parameter setting in the system mode.

(9) PC-1252

	0	1	2	3	4	5	6	7	8	9	A	B	C	D	E	F
0			0	@	P	`	p				€	À	Ð	à	ð	
1		!	1	A	Q	a	q				±	Á	Ñ	á	ñ	
2		"	2	B	R	b	r			¢	²	Â	Ò	â	ò	
3		#	3	C	S	c	s	f		£	³	Ã	Ó	ã	ó	
4		\$	4	D	T	d	t			¤	´	Ä	Ô	ä	ô	
5		%	5	E	U	e	u			¥	µ	Å	Õ	å	õ	
6		&	6	F	V	f	v			¦	¶	Æ	Ö	æ	ö	
7		'	7	G	W	g	w			§	·	Ç	×	ç	÷	
8		(8	H	X	h	x	^	~	¨	¸	È	Ø	è	ø	
9)	9	I	Y	i	y			©	¹	É	Ù	é	ù	
A		*	:	J	Z	j	z			ª	º	Ê	Ú	ê	ú	
B		+	;	K	[k	{			«	»	Ë	Û	ë	û	
C		,	<	L	\	l				¬	¼	Ì	Ü	ì	ü	
D		-	=	M]	m	}				½	Í	Ý	í	ý	
E		.	>	N	^	n	~			®	¾	Î	Þ	î	þ	
F		/	?	O	_	o					¿	Ï	ß	ï	ÿ	

When Japanese message is selected in the system mode, code 5CH indicates “¥”.

The Euro code (B0H) can be changed in the parameter setting in the system mode.

(10) PC-1253

	0	1	2	3	4	5	6	7	8	9	A	B	C	D	E	F
0			0	@	P	`	p				€					
1		!	1	A	Q	a	q				±					
2		"	2	B	R	b	r				²					
3		#	3	C	S	c	s	f		£	³					
4		\$	4	D	T	d	t			¤						
5		%	5	E	U	e	u			¥	µ					
6		&	6	F	V	f	v			¦	¶					
7		'	7	G	W	g	w			§	·					
8		(8	H	X	h	x			¨						
9)	9	I	Y	i	y			©						
A		*	:	J	Z	j	z			ª						
B		+	;	K	[k	{			«	»					
C		,	<	L	\	l				¬						
D		-	=	M]	m	}				½					
E		.	>	N	^	n	~			®						
F		/	?	O	_	o										

When Japanese message is selected in the system mode, code 5CH indicates “¥”.

The Euro code (B0H) can be changed in the parameter setting in the system mode.

(11) PC-1254

	0	1	2	3	4	5	6	7	8	9	A	B	C	D	E	F
0			0	@	P	`	p				€	À		à		
1		!	1	A	Q	a	q				±	Á	Ñ	á	ñ	
2		"	2	B	R	b	r			¢	²	Â	Ò	â	ò	
3		#	3	C	S	c	s	f		£	³	Ã	Ó	ã	ó	
4		\$	4	D	T	d	t			¤	´	Ä	Ô	ä	ô	
5		%	5	E	U	e	u			¥	µ	Å	Õ	å	õ	
6		&	6	F	V	f	v			¦	¶	Æ	Ö	æ	ö	
7		'	7	G	W	g	w			§	·	Ç	×	ç	÷	
8		(8	H	X	h	x	^	~	¨	¸	È	Ø	è	ø	
9)	9	I	Y	i	y			©	¹	É	Ù	é	ù	
A		*	:	J	Z	j	z			ª	º	Ê	Ú	ê	ú	
B		+	;	K	[k	{			«	»	Ë	Û	ë	û	
C		,	<	L	\	l				¬	¼	Ì	Ü	ì	ü	
D		-	=	M]	m	}				½	Í		í	¹	
E		.	>	N	^	n	~			®	¾	Î		î		
F		/	?	O	_	o					¿	Ï	ß	ï	ÿ	

When Japanese message is selected in the system mode, code 5CH indicates “¥”.

The Euro code (B0H) can be changed in the parameter setting in the system mode.

(12) PC-1257

	0	1	2	3	4	5	6	7	8	9	A	B	C	D	E	F
0			0	@	P	`	p				€					
1		!	1	A	Q	a	q				±					
2		"	2	B	R	b	r			¢	²					
3		#	3	C	S	c	s			£	³		Ó		ó	
4		\$	4	D	T	d	t			¤	´	Ä		ä		
5		%	5	E	U	e	u				µ	Å	Õ	å	õ	
6		&	6	F	V	f	v			¦	¶		Ö		ö	
7		'	7	G	W	g	w			§	·		×		÷	
8		(8	H	X	h	x			Ø	ø					
9)	9	I	Y	i	y			©	¹	É		é		
A		*	:	J	Z	j	z									
B		+	;	K	[k	{			«	»					
C		,	<	L	\	l				¬	¼		Ü		ü	
D		-	=	M]	m	}	¨	¸		½					
E		.	>	N	^	n	~			®	¾					
F		/	?	O	_	o				Æ	æ		ß			

When Japanese message is selected in the system mode, code 5CH indicates “¥”.

The Euro code (B0H) can be changed in the parameter setting in the system mode.

(13) LATIN9

	0	1	2	3	4	5	6	7	8	9	A	B	C	D	E	F
0			0	@	P	`	p				€	À	Ð	à	ð	
1		!	1	A	Q	a	q				ı	±	Á	Ñ	á	ñ
2		"	2	B	R	b	r				¢	²	Â	Ò	â	ò
3		#	3	C	S	c	s				£	³	Ã	Ó	ã	ó
4		\$	4	D	T	d	t				€		Ä	Ö	ä	ö
5		%	5	E	U	e	u				¥	μ	Å	Õ	å	õ
6		&	6	F	V	f	v					¶	Æ	Ö	æ	ö
7		'	7	G	W	g	w				§	·	Ç	x	ç	÷
8		(8	H	X	h	x						È	Ø	è	ø
9)	9	I	Y	i	y				©	¹	É	Ù	é	ù
A		*	:	J	Z	j	z				ª	º	Ê	Ú	ê	ú
B		+	;	K	[k	{				«	»	Ë	Û	ë	û
C		,	<	L	\	l					¬		Ì	Ü	ì	ü
D		-	=	M]	m	}						Í	Ý	í	ý
E		.	>	N	^	n	~				®		Î	Þ	î	þ
F		/	?	O	_	o	⌘					¿	Ï	ß	ï	ÿ

When Japanese message is selected in the system mode, code 5CH indicates “¥”.

The Euro code (B0H) can be changed in the parameter setting in the system mode.

(14) Arabic

	0	1	2	3	4	5	6	7	8	9	A	B	C	D	E	F
0			0	@	P	`	p					€				
1		!	1	A	Q	a	q									
2		"	2	B	R	b	r									
3		#	3	C	S	c	s									
4		\$	4	D	T	d	t									
5		%	5	E	U	e	u									
6		&	6	F	V	f	v									
7		'	7	G	W	g	w									
8		(8	H	X	h	x									
9)	9	I	Y	i	y									
A		*	:	J	Z	j	z									
B		+	;	K	[k	{									
C		,	<	L	\	l										
D		-	=	M]	m	}									
E		.	>	N	^	n	~									
F		/	?	O	_	o	⌘									

When Japanese message is selected in the system mode, code 5CH indicates “¥”.

The Euro code (B0H) can be changed in the parameter setting in the system mode.

12.2 PRESENTATION (Bit map font type: M)

(1) PC-850, PC-857

	0	1	2	3	4	5	6	7	8	9	A	B	C	D	E	F
0				0	@	P	`	P				€				-
1			!	1	A	Q	A	Q								
2			"	2	B	R	B	R								
3			#	3	C	S	C	S								
4			\$	4	D	T	D	T								
5			%	5	E	U	E	U								
6			&	6	F	V	F	V								
7			'	7	G	W	G	W								
8			(8	H	X	H	X								
9)	9	I	Y	I	Y								
A			*	:	J	Z	J	Z								
B			+	;	K	[K	{								
C			,	<	L	\	L									
D			-	=	M]	M	}								
E			.	>	N	^	N	~				¥				
F			/	?	O	_	O	⌘								

When Japanese message is selected in the system mode, code 5CH indicates “¥”.

The Euro code (B0H) can be changed in the parameter setting in the system mode.

(2) PC-8

	0	1	2	3	4	5	6	7	8	9	A	B	C	D	E	F
0				0	@	P	`	P				€				
1			!	1	A	Q	A	Q								
2			"	2	B	R	B	R								
3			#	3	C	S	C	S								
4			\$	4	D	T	D	T								
5			%	5	E	U	E	U								
6			&	6	F	V	F	V								
7			'	7	G	W	G	W								
8			(8	H	X	H	X								
9)	9	I	Y	I	Y								
A			*	:	J	Z	J	Z								
B			+	;	K	[K	{								
C			,	<	L	\	L									
D			-	=	M]	M	}		¥						
E			.	>	N	^	N	~								
F			/	?	O	_	O	⌘								

When Japanese message is selected in the system mode, code 5CH indicates “¥”.

The Euro code (B0H) can be changed in the parameter setting in the system mode.

(3) PC-852

	0	1	2	3	4	5	6	7	8	9	A	B	C	D	E	F
0				0	@	P	`	P				€				-
1			!	1	A	Q	A	Q								
2			"	2	B	R	B	R								
3			#	3	C	S	C	S								
4			\$	4	D	T	D	T								
5			%	5	E	U	E	U								
6			&	6	F	V	F	V								
7			'	7	G	W	G	W								
8			(8	H	X	H	X								
9)	9	I	Y	I	Y								
A			*	:	J	Z	J	Z								
B			+	;	K	[K	{								
C			,	<	L	\	L									
D			-	=	M]	M	}								
E			.	>	N	^	N	~								
F			/	?	O	_	O									

When Japanese message is selected in the system mode, code 5CH indicates “¥”.

The Euro code (B0H) can be changed in the parameter setting in the system mode.

(4) PC-851, PC-855, PC-1250, PC-1251, PC-1257, Arabic

	0	1	2	3	4	5	6	7	8	9	A	B	C	D	E	F
0				0	@	P	`	P				€				
1			!	1	A	Q	A	Q								
2			"	2	B	R	B	R								
3			#	3	C	S	C	S								
4			\$	4	D	T	D	T								
5			%	5	E	U	E	U								
6			&	6	F	V	F	V								
7			'	7	G	W	G	W								
8			(8	H	X	H	X								
9)	9	I	Y	I	Y								
A			*	:	J	Z	J	Z								
B			+	;	K	[K	{								
C			,	<	L	\	L									
D			-	=	M]	M	}								
E			.	>	N	^	N	~								
F			/	?	O	_	O	█								

When Japanese message is selected in the system mode, code 5CH indicates “¥”.

The Euro code (B0H) can be changed in the parameter setting in the system mode.

(5) PC-1252, PC-1254

	0	1	2	3	4	5	6	7	8	9	A	B	C	D	E	F
0				0	@	P	`	P				€				
1			!	1	A	Q	A	Q								
2			"	2	B	R	B	R								
3			#	3	C	S	C	S								
4			\$	4	D	T	D	T								
5			%	5	E	U	E	U			¥					
6			&	6	F	V	F	V								
7			'	7	G	W	G	W								
8			(8	H	X	H	X	^	~						
9)	9	I	Y	I	Y								
A			*	:	J	Z	J	Z								
B			+	;	K	[K	{								
C			,	<	L	\	L									
D			-	=	M]	M	}								
E			.	>	N	^	N	~								
F			/	?	O	_	O	█								

When Japanese message is selected in the system mode, code 5CH indicates “¥”.

The Euro code (B0H) can be changed in the parameter setting in the system mode.

(6) PC-1253

	0	1	2	3	4	5	6	7	8	9	A	B	C	D	E	F
0				0	@	P	`	P				€				-
1			!	1	A	Q	A	Q								
2			"	2	B	R	B	R								
3			#	3	C	S	C	S								
4			\$	4	D	T	D	T								
5			%	5	E	U	E	U			¥					
6			&	6	F	V	F	V								
7			'	7	G	W	G	W								
8			(8	H	X	H	X								
9)	9	I	Y	I	Y								
A			*	:	J	Z	J	Z								
B			+	;	K	[K	{								
C			,	<	L	\	L									
D			-	=	M]	M	}								
E			.	>	N	^	N	~								
F			/	?	O	_	O	█								

When Japanese message is selected in the system mode, code 5CH indicates “¥”.

The Euro code (B0H) can be changed in the parameter setting in the system mode.

(7) LATIN9

	0	1	2	3	4	5	6	7	8	9	A	B	C	D	E	F
0				0	@	P	`	P				€				
1			!	1	A	Q	A	Q								
2			"	2	B	R	B	R								
3			#	3	C	S	C	S								
4			\$	4	D	T	D	T			€					
5			%	5	E	U	E	U			¥					
6			&	6	F	V	F	V								
7			'	7	G	W	G	W								
8			(8	H	X	H	X								
9)	9	I	Y	I	Y								
A			.	:	J	Z	J	Z								
B			+	;	K	[K	{								
C			,	<	L	\	L									
D			-	=	M]	M	}								
E			.	>	N	^	N	~								
F			/	?	O	_	O	█								

When Japanese message is selected in the system mode, code 5CH indicates "¥".

The Euro code (B0H) can be changed in the parameter setting in the system mode.

12.3 OCR-A (Bit map font type: S)

(1) PC-850, PC-857

① B-SX4T

	0	1	2	3	4	5	6	7	8	9	A	B	C	D	E	F
0				0		P	rl									-
1				1	A	Q										
2			"	2	B	R										
3				3	C	S										
4			\$	4	D	T										
5				5	E	U										
6				6	F	V										
7				7	G	W										
8				8	H	X										
9				9	I	Y										
A					J	Z										
B			+		K											
C				<	L											
D			-		M											
E			.	>	N							¥				
F			/		O											

When Japanese message is selected in the system mode, code 5CH indicates “¥”.

② B-SX5T

	0	1	2	3	4	5	6	7	8	9	A	B	C	D	E	F
0				0	@	P	rl	p								-
1			!	1	A	Q	a	q								
2			"	2	B	R	b	r								
3			#	3	C	S	c	s								
4			\$	4	D	T	d	t								
5			%	5	E	U	e	u								
6			&	6	F	V	f	v								
7			'	7	G	W	g	w								
8			(8	H	X	h	x								
9)	9	I	Y	i	y								
A			*	:	J	Z	j	z								
B			+	;	K	[k	{								
C			,	<	L	\	l									
D			-	=	M]	m	}								
E			.	>	N	^	n	┘				¥				
F			/	?	O	┘	o	■								

When Japanese message is selected in the system mode, code 5CH indicates “¥”.

(2) PC-8

① B-SX4T

	0	1	2	3	4	5	6	7	8	9	A	B	C	D	E	F
0				0		P	rl									
1				1	A	Q										
2			"	2	B	R										
3				3	C	S										
4			\$	4	D	T										
5				5	E	U										
6				6	F	V										
7				7	G	W										
8				8	H	X										
9				9	I	Y										
A					J	Z										
B			+		K											
C				<	L											
D			-		M					¥						
E			.	>	N											
F			/		O											

When Japanese message is selected in the system mode, code 5CH indicates “¥”.

② B-SX5T

	0	1	2	3	4	5	6	7	8	9	A	B	C	D	E	F
0				0	@	P	rl	p								
1			!	1	A	Q	a	q								
2			"	2	B	R	b	r								
3			#	3	C	S	c	s								
4			\$	4	D	T	d	t								
5			%	5	E	U	e	u								
6			&	6	F	V	f	v								
7			'	7	G	W	g	w								
8			(8	H	X	h	x								
9)	9	I	Y	i	y								
A			*	:	J	Z	j	z								
B			+	;	K	[k	{								
C			,	<	L	\	l									
D			-	=	M]	m	}		¥						
E			.	>	N	^	n	∩								
F			/	?	O	∪	o	■								

When Japanese message is selected in the system mode, code 5CH indicates “¥”.

(3) PC-852

① B-SX4T

	0	1	2	3	4	5	6	7	8	9	A	B	C	D	E	F
0				0		P	rl									-
1				1	A	Q										
2			"	2	B	R										
3				3	C	S										
4			\$	4	D	T										
5				5	E	U										
6				6	F	V										
7				7	G	W										
8				8	H	X										
9				9	I	Y										
A					J	Z										
B			+		K											
C				<	L											
D			-		M											
E			.	>	N											
F			/		O											

When Japanese message is selected in the system mode, code 5CH indicates “¥”.

② B-SX5T

	0	1	2	3	4	5	6	7	8	9	A	B	C	D	E	F
0				0	@	P	rl	p								-
1			!	1	A	Q	a	q								
2			"	2	B	R	b	r								
3			#	3	C	S	c	s								
4			\$	4	D	T	d	t								
5			%	5	E	U	e	u								
6			&	6	F	V	f	v								
7			'	7	G	W	g	w								
8			(8	H	X	h	x								
9)	9	I	Y	i	y								
A			*	:	J	Z	j	z								
B			+	;	K	[k	{								
C			,	<	L	\	l									
D			-	=	M]	m	}								
E			.	>	N	^	n	▮								
F			/	?	O	┘	o	■								

When Japanese message is selected in the system mode, code 5CH indicates “¥”.

(4) PC-851, PC-855, PC-1250, PC-1251, PC-1257, Arabic

① B-SX4T

	0	1	2	3	4	5	6	7	8	9	A	B	C	D	E	F
0				0		P	ړ									
1				1	A	Q										
2			"	2	B	R										
3				3	C	S										
4			\$	4	D	T										
5				5	E	U										
6				6	F	V										
7				7	G	W										
8				8	H	X										
9				9	I	Y										
A					J	Z										
B			+		K											
C				<	L											
D			-		M											
E			.	>	N											
F			/		O											

When Japanese message is selected in the system mode, code 5CH indicates “¥”.

② B-SX5T

	0	1	2	3	4	5	6	7	8	9	A	B	C	D	E	F
0				0	@	P	ړ	p								
1			!	1	A	Q	a	q								
2			"	2	B	R	b	r								
3			#	3	C	S	c	s								
4			\$	4	D	T	d	t								
5			%	5	E	U	e	u								
6			&	6	F	V	f	v								
7			'	7	G	W	g	w								
8			(8	H	X	h	x								
9)	9	I	Y	i	y								
A			*	:	J	Z	j	z								
B			+	;	K	[k	{								
C			,	<	L	\	l									
D			-	=	M]	m	}								
E			.	>	N	^	n	␣								
F			/	?	O	␣	o	■								

When Japanese message is selected in the system mode, code 5CH indicates “¥”.

(5) PC-1252, PC-1254

① B-SX4T

	0	1	2	3	4	5	6	7	8	9	A	B	C	D	E	F	
0				0		P	rl										-
1				1	A	Q											
2			"	2	B	R											
3				3	C	S											
4			\$	4	D	T											
5				5	E	U					¥						
6				6	F	V											
7				7	G	W											
8				8	H	X			^	~							
9				9	I	Y											
A					J	Z											
B			+		K												
C				<	L												
D			-		M												
E			.	>	N												
F			/		O												

When Japanese message is selected in the system mode, code 5CH indicates “¥”.

② B-SX5T

	0	1	2	3	4	5	6	7	8	9	A	B	C	D	E	F	
0				0	@	P	rl	p									-
1			!	1	A	Q	a	q									
2			"	2	B	R	b	r									
3			#	3	C	S	c	s									
4			\$	4	D	T	d	t									
5			%	5	E	U	e	u			¥						
6			&	6	F	V	f	v									
7			'	7	G	W	g	w									
8			(8	H	X	h	x	^	~							
9)	9	I	Y	i	y									
A			*	:	J	Z	j	z									
B			+	;	K	[k	{									
C			,	<	L	\	l										
D			-	=	M]	m	}									
E			.	>	N	^	n	∩									
F			/	?	O	∪	o	■									

When Japanese message is selected in the system mode, code 5CH indicates “¥”.

(6) PC-1253

① B-SX4T

	0	1	2	3	4	5	6	7	8	9	A	B	C	D	E	F
0				0		P	rl									-
1				1	A	Q										
2			"	2	B	R										
3				3	C	S										
4			\$	4	D	T										
5				5	E	U					¥					
6				6	F	V										
7				7	G	W										
8				8	H	X										
9				9	I	Y										
A					J	Z										
B			+		K											
C			<		L											
D			-		M											
E			.	>	N											
F			/		O											

When Japanese message is selected in the system mode, code 5CH indicates “¥”.

② B-SX5T

	0	1	2	3	4	5	6	7	8	9	A	B	C	D	E	F
0				0	@	P	rl	p								-
1			!	1	A	Q	a	q								
2			"	2	B	R	b	r								
3			#	3	C	S	c	s								
4			\$	4	D	T	d	t								
5			%	5	E	U	e	u			¥					
6			&	6	F	V	f	v								
7			'	7	G	W	g	w								
8			(8	H	X	h	x								
9)	9	I	Y	i	y								
A			*	:	J	Z	j	z								
B			+	;	K	[k	{								
C			,	<	L	\	l									
D			-	=	M]	m	}								
E			.	>	N	^	n	▮								
F			/	?	O	┘	o	■								

When Japanese message is selected in the system mode, code 5CH indicates “¥”.

(7) LATIN9

① B-SX4T

	0	1	2	3	4	5	6	7	8	9	A	B	C	D	E	F
0				0		P	rl									
1				1	A	Q										
2			"	2	B	R										
3				3	C	S										
4			\$	4	D	T										
5				5	E	U					¥					
6				6	F	V										
7				7	G	W										
8				8	H	X										
9				9	I	Y										
A					J	Z										
B			+		K											
C				<	L											
D			-		M											
E			.	>	N											
F			/		O											

When Japanese message is selected in the system mode, code 5CH indicates “¥”.

② B-SX5T

	0	1	2	3	4	5	6	7	8	9	A	B	C	D	E	F
0				0	@	P	rl	p								
1			!	1	A	Q	a	q								
2			"	2	B	R	b	r								
3			#	3	C	S	c	s								
4			\$	4	D	T	d	t								
5			%	5	E	U	e	u			¥					
6			&	6	F	V	f	v								
7			'	7	G	W	g	w								
8			(8	H	X	h	x								
9)	9	I	Y	i	y								
A			*	:	J	Z	j	z								
B			+	;	K	[k	{								
C			,	<	L	\	l									
D			-	=	M]	m	}								
E			.	>	N	^	n	┘								
F			/	?	O	┘	o	■								

When Japanese message is selected in the system mode, code 5CH indicates “¥”.

12.4 OCR-B (Bit map font type: T)

(1) PC-850, PC-857

① B-SX4T

	0	1	2	3	4	5	6	7	8	9	A	B	C	D	E	F
0				0		P			0							-
1				1	A	Q			1							
2			"	2	B	R			2							
3				3	C	S			3							
4			\$	4	D	T			4							
5				5	E	U			5							
6				6	F	V			6							
7				7	G	W			7							
8				8	H	X			8							
9				9	I	Y			9							
A					J	Z										
B			+		K											
C				<	L											
D			-		M											
E			.	>	N							¥				
F			/		O											

When Japanese message is selected in the system mode, code 5CH indicates "¥".

The size of the numerals of codes 80h ~ 89h are reduced to 80%.

② B-SX5T

	0	1	2	3	4	5	6	7	8	9	A	B	C	D	E	F
0				0	@	P	`	p	0							-
1			!	1	A	Q	a	q	1							
2			"	2	B	R	b	r	2							
3			#	3	C	S	c	s	3							
4			\$	4	D	T	d	t	4							
5			%	5	E	U	e	u	5							
6			&	6	F	V	f	v	6							
7			'	7	G	W	g	w	7							
8			(8	H	X	h	x	8							
9)	9	I	Y	i	y	9							
A			*	:	J	Z	j	z								
B			+	;	K	[k	{								
C			,	<	L	\	l									
D			-	=	M]	m	}								
E			.	>	N	^	n	~				¥				
F			/	?	O	_	o	■								

When Japanese message is selected in the system mode, code 5CH indicates "¥".

The size of the numerals of codes 80h ~ 89h are reduced to 80%.

(2) PC-8

① B-SX4T

	0	1	2	3	4	5	6	7	8	9	A	B	C	D	E	F
0				0		P			0							
1				1	A	Q			1							
2			"	2	B	R			2							
3				3	C	S			3							
4			\$	4	D	T			4							
5				5	E	U			5							
6				6	F	V			6							
7				7	G	W			7							
8				8	H	X			8							
9				9	I	Y			9							
A					J	Z										
B			+		K											
C				<	L											
D			-		M				¥							
E			.	>	N											
F			/		O											

When Japanese message is selected in the system mode, code 5CH indicates “¥”.

The size of the numerals of codes 80h ~ 89h are reduced to 80%.

② B-SX5T

	0	1	2	3	4	5	6	7	8	9	A	B	C	D	E	F
0				0	@	P	`	p	0							
1			!	1	A	Q	a	q	1							
2			"	2	B	R	b	r	2							
3			#	3	C	S	c	s	3							
4			\$	4	D	T	d	t	4							
5			%	5	E	U	e	u	5							
6			&	6	F	V	f	v	6							
7			'	7	G	W	g	w	7							
8			(8	H	X	h	x	8							
9)	9	I	Y	i	y	9							
A			*	:	J	Z	j	z								
B			+	;	K	[k	{								
C			,	<	L	\	l									
D			-	=	M]	m	}	¥							
E			.	>	N	^	n	~								
F			/	?	O	_	o	█								

When Japanese message is selected in the system mode, code 5CH indicates “¥”.

The size of the numerals of codes 80h ~ 89h are reduced to 80%.

(3) PC-852

① B-SX4T

	0	1	2	3	4	5	6	7	8	9	A	B	C	D	E	F	
0				0		P			0								-
1				1	A	Q			1								
2			"	2	B	R			2								
3				3	C	S			3								
4			\$	4	D	T			4								
5				5	E	U			5								
6				6	F	V			6								
7				7	G	W			7								
8				8	H	X			8								
9				9	I	Y			9								
A					J	Z											
B			+		K												
C				<	L												
D			-		M												
E			.	>	N												
F			/		O												

When Japanese message is selected in the system mode, code 5CH indicates “¥”.

The size of the numerals of codes 80h ~ 89h are reduced to 80%.

② B-SX5T

	0	1	2	3	4	5	6	7	8	9	A	B	C	D	E	F	
0				0	@	P	`	p	0								-
1			!	1	A	Q	a	q	1								
2			"	2	B	R	b	r	2								
3			#	3	C	S	c	s	3								
4			\$	4	D	T	d	t	4								
5			%	5	E	U	e	u	5								
6			&	6	F	V	f	v	6								
7			'	7	G	W	g	w	7								
8			(8	H	X	h	x	8								
9)	9	I	Y	i	y	9								
A			*	:	J	Z	j	z									
B			+	;	K	[k	{									
C			,	<	L	\	l										
D			-	=	M]	m	}									
E			.	>	N	^	n	~									
F			/	?	O	_	o	█									

When Japanese message is selected in the system mode, code 5CH indicates “¥”.

The size of the numerals of codes 80h ~ 89h are reduced to 80%.

(4) PC-851, PC-855, PC-1250, PC-1251, PC-1257, Arabic

① B-SX4T

	0	1	2	3	4	5	6	7	8	9	A	B	C	D	E	F
0				0		P			0							
1				1	A	Q			1							
2			"	2	B	R			2							
3				3	C	S			3							
4			\$	4	D	T			4							
5				5	E	U			5							
6				6	F	V			6							
7				7	G	W			7							
8				8	H	X			8							
9				9	I	Y			9							
A					J	Z										
B			+		K											
C				<	L											
D			-		M											
E			.	>	N											
F			/		O											

When Japanese message is selected in the system mode, code 5CH indicates “¥”.

The size of the numerals of codes 80h ~ 89h are reduced to 80%.

② B-SX5T

	0	1	2	3	4	5	6	7	8	9	A	B	C	D	E	F
0				0	@	P	`	p	0							
1			!	1	A	Q	a	q	1							
2			"	2	B	R	b	r	2							
3			#	3	C	S	c	s	3							
4			\$	4	D	T	d	t	4							
5			%	5	E	U	e	u	5							
6			&	6	F	V	f	v	6							
7			'	7	G	W	g	w	7							
8			(8	H	X	h	x	8							
9)	9	I	Y	i	y	9							
A			*	:	J	Z	j	z								
B			+	;	K	[k	{								
C			,	<	L	\	l									
D			-	=	M]	m	}								
E			.	>	N	^	n	~								
F			/	?	O	_	o									

When Japanese message is selected in the system mode, code 5CH indicates “¥”.

The size of the numerals of codes 80h ~ 89h are reduced to 80%.

(5) PC-1252, PC-1254, LATIN9

① B-SX4T

	0	1	2	3	4	5	6	7	8	9	A	B	C	D	E	F
0				0		P			0							
1				1	A	Q			1							
2			"	2	B	R			2							
3				3	C	S			3							
4			\$	4	D	T			4							
5				5	E	U			5		¥					
6				6	F	V			6							
7				7	G	W			7							
8				8	H	X			8	~						
9				9	I	Y			9							
A					J	Z										
B			+		K											
C				<	L											
D			-		M											
E			.	>	N											
F			/		O											

When Japanese message is selected in the system mode, code 5CH indicates “¥”.

The size of the numerals of codes 80h ~ 89h are reduced to 80%.

② B-SX5T

	0	1	2	3	4	5	6	7	8	9	A	B	C	D	E	F
0				0	@	P	`	p	0							
1			!	1	A	Q	a	q	1							
2			"	2	B	R	b	r	2							
3			#	3	C	S	c	s	3							
4			\$	4	D	T	d	t	4							
5			%	5	E	U	e	u	5		¥					
6			&	6	F	V	f	v	6							
7			'	7	G	W	g	w	7							
8			(8	H	X	h	x	8	~						
9)	9	I	Y	i	y	9							
A			*	:	J	Z	j	z								
B			+	;	K	[k	{								
C			,	<	L	\	l									
D			-	=	M]	m	}								
E			.	>	N	^	n	~								
F			/	?	O	_	o	█								

When Japanese message is selected in the system mode, code 5CH indicates “¥”.

The size of the numerals of codes 80h ~ 89h are reduced to 80%.

(6) PC-1253

① B-SX4T

	0	1	2	3	4	5	6	7	8	9	A	B	C	D	E	F
0				0		P			0							
1				1	A	Q			1							
2			"	2	B	R			2							
3				3	C	S			3							
4			\$	4	D	T			4							
5				5	E	U			5		¥					
6				6	F	V			6							
7				7	G	W			7							
8				8	H	X			8							
9				9	I	Y			9							
A					J	Z										
B			+		K											
C				<	L											
D			-		M											
E			.	>	N											
F			/		O											

When Japanese message is selected in the system mode, code 5CH indicates “¥”.

The size of the numerals of codes 80h ~ 89h are reduced to 80%.

② B-SX5T

	0	1	2	3	4	5	6	7	8	9	A	B	C	D	E	F
0				0	@	P	`	p	0							
1			!	1	A	Q	a	q	1							
2			"	2	B	R	b	r	2							
3			#	3	C	S	c	s	3							
4			\$	4	D	T	d	t	4							
5			%	5	E	U	e	u	5		¥					
6			&	6	F	V	f	v	6							
7			'	7	G	W	g	w	7							
8			(8	H	X	h	x	8							
9)	9	I	Y	i	y	9							
A			*	:	J	Z	j	z								
B			+	;	K	[k	{								
C			,	<	L	\	l									
D			-	=	M]	m	}								
E			.	>	N	^	n	~								
F			/	?	O	_	o									

When Japanese message is selected in the system mode, code 5CH indicates “¥”.

The size of the numerals of codes 80h ~ 89h are reduced to 80%.

12.5 TEC OUTLINE FONT 1 (Outline font type: A, B)

(1) PC-850

	0	1	2	3	4	5	6	7	8	9	A	B	C	D	E	F
0			0	@	P	`	p	Ç	É	á	€					-
1		!	1	A	Q	a	q	ü	æ	í	€				ß	±
2		"	2	B	R	b	r	é	Æ	ó						
3		#	3	C	S	c	s	â	ô	ú						
4		\$	4	D	T	d	t	ä	ö	ñ					õ	
5		%	5	E	U	e	u	à	ò	Ñ						§
6		&	6	F	V	f	v	â	û	ª		ã			µ	÷
7		'	7	G	W	g	w	ç	ù	º						
8		(8	H	X	h	x	ê	ÿ	¿						°
9)	9	I	Y	i	y	ë	Ö							
A		*	:	J	Z	j	z	è	Ü	¬						•
B		+	;	K	[k	{	ï	ø	½						
C		,	<	L	\	l		î	£	¼						
D		-	=	M]	m	}	ì	Ø	¡	¢					²
E		.	>	N	^	n	~	Ä		«	¥					■
F		/	?	O	_	o	△	Å	f	»		¤				

The Euro code (B0H) can be changed in the parameter setting in the system mode.

(2) PC-8

	0	1	2	3	4	5	6	7	8	9	A	B	C	D	E	F
0			0	@	P	`	p	Ç	É	á	€				α	≡
1		!	1	A	Q	a	q	ü	æ	í	€				β	±
2		"	2	B	R	b	r	é	Æ	ó					Γ	≥
3		#	3	C	S	c	s	â	ô	ú					π	≤
4		\$	4	D	T	d	t	ä	ö	ñ					Σ	∫
5		%	5	E	U	e	u	à	ò	Ñ					σ	∫
6		&	6	F	V	f	v	â	û	ª					µ	÷
7		'	7	G	W	g	w	ç	ù	º					τ	≈
8		(8	H	X	h	x	ê	ÿ	¿					Φ	°
9)	9	I	Y	i	y	ë	Ö						Θ	•
A		*	:	J	Z	j	z	è	Ü	¬					Ω	•
B		+	;	K	[k	{	ï	ø	½					δ	√
C		,	<	L	\	l		î	£	¼					∞	n
D		-	=	M]	m	}	ì	¥	¡					∅	²
E		.	>	N	^	n	~	Ä	Pt	«					ε	■
F		/	?	O	_	o	△	Å	∫	»					∩	

The Euro code (B0H) can be changed in the parameter setting in the system mode.

(3) PC-852

	0	1	2	3	4	5	6	7	8	9	A	B	C	D	E	F
0			0	@	P	`	p	Ç	É	á	€					-
1		!	1	A	Q	a	q	ü		í	€				ß	
2		"	2	B	R	b	r	é		ó						
3		#	3	C	S	c	s	â	ô	ú						
4		\$	4	D	T	d	t	ä	ö							
5		%	5	E	U	e	u									§
6		&	6	F	V	f	v									÷
7		'	7	G	W	g	w	ç								
8		(8	H	X	h	x									°
9)	9	I	Y	i	y	ë	Ö							
A		*	:	J	Z	j	z		Ü	¬						•
B		+	;	K	[k	{									
C		,	<	L	\	l		î								
D		-	=	M]	m	}									
E		.	>	N	^	n	~	Ä		«						■
F		/	?	O	_	o	△			»		α				

The Euro code (B0H) can be changed in the parameter setting in the system mode.

(4) PC-857

	0	1	2	3	4	5	6	7	8	9	A	B	C	D	E	F
0			0	@	P	`	p	Ç	É	á	€		º			-
1		!	1	A	Q	a	q	ü	æ	í	€		ª	ß	±	
2		"	2	B	R	b	r	é	Æ	ó						
3		#	3	C	S	c	s	â	ô	ú						
4		\$	4	D	T	d	t	ä	ö	ñ				õ		
5		%	5	E	U	e	u	à	ò	Ñ						§
6		&	6	F	V	f	v	â	û			ã		µ	÷	
7		'	7	G	W	g	w	ç	ù							
8		(8	H	X	h	x	ê		¿						°
9)	9	I	Y	i	y	ë	Ö							
A		*	:	J	Z	j	z	è	Ü	¬						•
B		+	;	K	[k	{	ï	ø	½						
C		,	<	L	\	l		î	£	¼					ì	
D		-	=	M]	m	}		Ø	í	¢				ÿ	₂
E		.	>	N	^	n	~	Ä		«	¥					■
F		/	?	O	_	o	Ä			»		α				

The Euro code (B0H) can be changed in the parameter setting in the system mode.

(5) PC-851

	0	1	2	3	4	5	6	7	8	9	A	B	C	D	E	F
0			0	@	P	`	p	Ç				€				
1		!	1	A	Q	a	q	ü				€				±
2		"	2	B	R	b	r	é								
3		#	3	C	S	c	s	â	ô							
4		\$	4	D	T	d	t	ä	ö							
5		%	5	E	U	e	u	à								§
6		&	6	F	V	f	v		û							
7		'	7	G	W	g	w	ç	ù							
8		(8	H	X	h	x	ê								°
9)	9	I	Y	i	y	ë	Ö							
A		*	:	J	Z	j	z	è	Ü							
B		+	;	K	[k	{	ï		½						
C		,	<	L	\	l		î	£							
D		-	=	M]	m	}									
E		.	>	N	^	n	~	Ä		«						■
F		/	?	O	_	o	△			»						

The Euro code (B0H) can be changed in the parameter setting in the system mode.

(6) PC-855

	0	1	2	3	4	5	6	7	8	9	A	B	C	D	E	F
0			0	@	P	`	p					€				
1		!	1	A	Q	a	q					€				
2		"	2	B	R	b	r									
3		#	3	C	S	c	s									
4		\$	4	D	T	d	t									
5		%	5	E	U	e	u									
6		&	6	F	V	f	v									
7		'	7	G	W	g	w									
8		(8	H	X	h	x									
9)	9	I	Y	i	y									
A		*	:	J	Z	j	z									
B		+	;	K	[k	{									
C		,	<	L	\	l										
D		-	=	M]	m	}									§
E		.	>	N	^	n	~				«					■
F		/	?	O	_	o	△				»		α			

The Euro code (B0H) can be changed in the parameter setting in the system mode.

(7) PC-1250

	0	1	2	3	4	5	6	7	8	9	A	B	C	D	E	F
0				0	@	P	`	p				€				
1			!	1	A	Q	a	q				€			á	
2			"	2	B	R	b	r							â	
3			#	3	C	S	c	s								ó
4			\$	4	D	T	d	t			¤		Ä		ä	ô
5			%	5	E	U	e	u				μ				
6			&	6	F	V	f	v						Ö		ö
7			'	7	G	W	g	w			§	·	Ç		ç	÷
8			(8	H	X	h	x								
9)	9	I	Y	i	y					É		é	
A			*	:	J	Z	j	z								ú
B			+	;	K	[k	{			«	»			ë	
C			,	<	L	\	l				¬			Ü		ü
D			-	=	M]	m	}							í	
E			.	>	N	^	n	~							î	
F			/	?	O	_	o	△						ß		

The Euro code (B0H) can be changed in the parameter setting in the system mode.

(8) PC-1251

	0	1	2	3	4	5	6	7	8	9	A	B	C	D	E	F
0				0	@	P	`	p				€				
1			!	1	A	Q	a	q				€				
2			"	2	B	R	b	r								
3			#	3	C	S	c	s								
4			\$	4	D	T	d	t			¤					
5			%	5	E	U	e	u				μ				
6			&	6	F	V	f	v								
7			'	7	G	W	g	w			§	·				
8			(8	H	X	h	x								
9)	9	I	Y	i	y								
A			*	:	J	Z	j	z								
B			+	;	K	[k	{			«	»				
C			,	<	L	\	l				¬					
D			-	=	M]	m	}								
E			.	>	N	^	n	~								
F			/	?	O	_	o	△								

The Euro code (B0H) can be changed in the parameter setting in the system mode.

(9) PC-1252

	0	1	2	3	4	5	6	7	8	9	A	B	C	D	E	F
0				0	@	P	`	p				€			à	
1			!	1	A	Q	a	q			ı	€		Ñ	á	ñ
2			"	2	B	R	b	r			ç	²			â	ò
3			#	3	C	S	c	s	f		£				ã	ó
4			\$	4	D	T	d	t			¤		Ä		ä	ô
5			%	5	E	U	e	u			¥	μ	Å		å	õ
6			&	6	F	V	f	v					Æ	Ö	æ	ö
7			'	7	G	W	g	w			§	·	Ç		ç	÷
8			(8	H	X	h	x	^	~				Ø	è	ø
9)	9	I	Y	i	y							é	ù
A			*	:	J	Z	j	z			a				ê	ú
B			+	;	K	[k	{			«	»			ë	û
C			,	<	L	\	l				¬	¼		Ü	ì	ü
D			-	=	M]	m	}				½			í	
E			.	>	N	^	n	~							î	
F			/	?	O	_	o	△				ı		ß	ï	ÿ

The Euro code (B0H) can be changed in the parameter setting in the system mode.

(10) PC-1253

	0	1	2	3	4	5	6	7	8	9	A	B	C	D	E	F
0				0	@	P	`	p				€				
1			!	1	A	Q	a	q				€				
2			"	2	B	R	b	r				²				
3			#	3	C	S	c	s	f		£					
4			\$	4	D	T	d	t			¤					
5			%	5	E	U	e	u			¥	μ				
6			&	6	F	V	f	v								
7			'	7	G	W	g	w			§	·				
8			(8	H	X	h	x								
9)	9	I	Y	i	y								
A			*	:	J	Z	j	z			a					
B			+	;	K	[k	{			«	»				
C			,	<	L	\	l				¬					
D			-	=	M]	m	}				½				
E			.	>	N	^	n	~								
F			/	?	O	_	o	△								

The Euro code (B0H) can be changed in the parameter setting in the system mode.

(11) PC-1254

	0	1	2	3	4	5	6	7	8	9	A	B	C	D	E	F
0				0	@	P	`	p				€			à	
1			!	1	A	Q	a	q			ı	€		Ñ	á	ñ
2			"	2	B	R	b	r			ç	²			â	ò
3			#	3	C	S	c	s	f		£				ã	ó
4			\$	4	D	T	d	t			¤		Ä		ä	ô
5			%	5	E	U	e	u			¥	μ	Å		å	õ
6			&	6	F	V	f	v					Æ	Ö	æ	ö
7			'	7	G	W	g	w			§	·	Ç		ç	÷
8			(8	H	X	h	x	^	~				Ø	è	ø
9)	9	I	Y	i	y					É		é	ù
A			*	:	J	Z	j	z			ª	º			ê	ú
B			+	;	K	[k	{			«	»			ë	û
C			,	<	L	\	l				¬	¼		Ü	ì	ü
D			-	=	M]	m	}				½			í	
E			.	>	N	^	n	~							î	
F			/	?	O	_	o	△				ı		ß	ï	ÿ

The Euro code (B0H) can be changed in the parameter setting in the system mode.

(12) PC-1257

	0	1	2	3	4	5	6	7	8	9	A	B	C	D	E	F
0				0	@	P	`	p				€				
1			!	1	A	Q	a	q				€				
2			"	2	B	R	b	r			ç	²				
3			#	3	C	S	c	s			£					ó
4			\$	4	D	T	d	t			¤		Ä		ä	
5			%	5	E	U	e	u				μ	Å		å	õ
6			&	6	F	V	f	v						Ö		ö
7			'	7	G	W	g	w			§	·				÷
8			(8	H	X	h	x			Ø	ø				
9)	9	I	Y	i	y					É		é	
A			*	:	J	Z	j	z								
B			+	;	K	[k	{			«	»				
C			,	<	L	\	l				¬	¼		Ü		ü
D			-	=	M]	m	}				½				
E			.	>	N	^	n	~								
F			/	?	O	_	o	△			Æ	æ		ß		

The Euro code (B0H) can be changed in the parameter setting in the system mode.

(13) LATIN9

	0	1	2	3	4	5	6	7	8	9	A	B	C	D	E	F
0				0	@	P	`	p				€			à	
1			!	1	A	Q	a	q			ı	€		Ñ	á	ñ
2			"	2	B	R	b	r			ç	²			â	ò
3			#	3	C	S	c	s			£				ã	ó
4			\$	4	D	T	d	t			¤		Ä		ä	ô
5			%	5	E	U	e	u			¥	µ	Å		å	õ
6			&	6	F	V	f	v					Æ	Ö	æ	ö
7			'	7	G	W	g	w			§	·	Ç		ç	÷
8			(8	H	X	h	x						Ø	è	ø
9)	9	I	Y	i	y					É		é	ù
A			*	:	J	Z	j	z			ª	º			ê	ú
B			+	;	K	[k	{			«	»			ë	û
C			,	<	L	\	l				¬			Ü	ì	ü
D			-	=	M]	m	}							í	
E			.	>	N	^	n	~							î	
F			/	?	O	_	o					ı		ß	İ	ÿ

The Euro code (B0H) can be changed in the parameter setting in the system mode.

(14) Arabic

	0	1	2	3	4	5	6	7	8	9	A	B	C	D	E	F
0				0	@	P	`	p				€				
1			!	1	A	Q	a	q				€				
2			"	2	B	R	b	r								
3			#	3	C	S	c	s								
4			\$	4	D	T	d	t								
5			%	5	E	U	e	u								
6			&	6	F	V	f	v								
7			'	7	G	W	g	w								
8			(8	H	X	h	x								
9)	9	I	Y	i	y								
A			*	:	J	Z	j	z								
B			+	;	K	[k	{								
C			,	<	L	\	l									
D			-	=	M]	m	}								
E			.	>	N	^	n	~								
F			/	?	O	_	o	△								

The Euro code (B0H) can be changed in the parameter setting in the system mode.

12.6 PRICE FONT 1, 2, 3 (Outline font type: E, F, G)

(1) All types of character codes

	0	1	2	3	4	5	6	7	8	9	A	B	C	D	E	F
0				0	円											-
1				1												
2				2												
3				3												
4			\$	4												
5			%	5												
6				6												
7				7												
8				8												
9				9												
A																
B																
C			,		¥											
D			-													
E			.					~								
F			/													

12.7 TEC OUTLINE FONT 2, 3, GOTHIC725 BLACK (Outline font type: H, I, J)

(1) PC-850

	0	1	2	3	4	5	6	7	8	9	A	B	C	D	E	F
0			0	@	P	`	p	Ç	É	á	€			ð	Ó	-
1		!	1	A	Q	a	q	ü	æ	í				Ð	ß	±
2		"	2	B	R	b	r	é	Æ	ó				Ê	Ô	=
3		#	3	C	S	c	s	â	ô	ú				Ë	Ò	¾
4		\$	4	D	T	d	t	ä	ö	ñ				È	õ	¶
5		%	5	E	U	e	u	à	ò	Ñ	Á			Ì	Õ	§
6		&	6	F	V	f	v	â	û	ª	Â	ã	í	µ	÷	
7		'	7	G	W	g	w	ç	ù	º	À	Ã	Î	þ	¸	
8		(8	H	X	h	x	ê	ÿ	¿	©			Ï	ƒ	°
9)	9	I	Y	i	y	ë	Ö	®				Ú	ˆ	
A		*	:	J	Z	j	z	è	Ü	¬				Û	•	
B		+	;	K	[k	{	ï	ø	½				Ü	¹	
C		,	<	L	\	l		î	£	¼				Ý	³	
D		-	=	M]	m	}	ì	∅	¡	¢			ÿ	²	
E		.	>	N	^	n	~	Ä	x	«	¥			ı	˘	■
F		/	?	O	_	o		Å	f	»		¤		ı	˙	

When Japanese message is selected in the system mode, code 5CH indicates “¥”.

The Euro code (B0H) can be changed in the parameter setting in the system mode.

(2) PC-8

	0	1	2	3	4	5	6	7	8	9	A	B	C	D	E	F
0			0	@	P	`	p	Ç	É	á	€					
1		!	1	A	Q	a	q	ü	æ	í						±
2		"	2	B	R	b	r	é	Æ	ó						
3		#	3	C	S	c	s	â	ô	ú						
4		\$	4	D	T	d	t	ä	ö	ñ						
5		%	5	E	U	e	u	à	ò	Ñ						
6		&	6	F	V	f	v	â	û	ª					µ	÷
7		'	7	G	W	g	w	ç	ù	º						
8		(8	H	X	h	x	ê	ÿ	¿						°
9)	9	I	Y	i	y	ë	Ö							
A		*	:	J	Z	j	z	è	Ü	¬						•
B		+	;	K	[k	{	ï	ø	½						
C		,	<	L	\	l		î	£	¼						
D		-	=	M]	m	}	ì	¥	¡						²
E		.	>	N	^	n	~	Ä		«						■
F		/	?	O	_	o		Å	f	»						

When Japanese message is selected in the system mode, code 5CH indicates “¥”.

The Euro code (B0H) can be changed in the parameter setting in the system mode.

(3) PC-852

	0	1	2	3	4	5	6	7	8	9	A	B	C	D	E	F
0			0	@	P	`	p	Ç	É	á	€			đ	Ó	-
1		!	1	A	Q	a	q	ü	Ł	í				Đ	ß	~
2		"	2	B	R	b	r	é	Í	ó				Ď	Ô	˘
3		#	3	C	S	c	s	â	ô	ú				Ě	Ń	˙
4		\$	4	D	T	d	t	ä	ö	Å				ď	ń	˘
5		%	5	E	U	e	u	ű	Ĺ	ą	Á			Ň	ň	§
6		&	6	F	V	f	v	ć	İ	Ž	Â	Ă		Í	Š	÷
7		'	7	G	W	g	w	ç	Ś	ż	Ě	ă		Î	š	˘
8		(8	H	X	h	x	ł	ś	Ę	Ş			ě	Ŕ	°
9)	9	I	Y	i	y	ë	Ö	ę					Ú	˘
A		*	:	J	Z	j	z	Ő	Ü	–					ı	•
B		+	;	K	[k	{	ő	Ű	ž					Ű	ű
C		,	<	L	\	l		î	ı	Č					ý	Ŕ
D		-	=	M]	m	}	Ž	ł	s	Ż			Ť	Y	ř
E		.	>	N	^	n	~	Ä	x	«	ž			Ů	t	■
F		/	?	O	_	o		Ć	ç	»			α			

When Japanese message is selected in the system mode, code 5CH indicates “¥”.
The Euro code (B0H) can be changed in the parameter setting in the system mode.

(4) PC-857

	0	1	2	3	4	5	6	7	8	9	A	B	C	D	E	F
0			0	@	P	`	p	Ç	É	á	€			º	Ó	-
1		!	1	A	Q	a	q	ü	æ	í				ª	ß	±
2		"	2	B	R	b	r	é	Æ	ó				Ê	Ô	
3		#	3	C	S	c	s	â	ô	ú				Ë	Ò	¾
4		\$	4	D	T	d	t	ä	ö	ñ				È	õ	¶
5		%	5	E	U	e	u	à	ò	Ñ	Á				Õ	§
6		&	6	F	V	f	v	â	û	Ğ	Â	Ă		Í	µ	÷
7		'	7	G	W	g	w	ç	ù	ğ	À	Ã		Î		˘
8		(8	H	X	h	x	ê	ı	ı	©			İ	x	°
9)	9	I	Y	i	y	ë	Ö	®					Ú	˘
A		*	:	J	Z	j	z	è	Ü	–					Û	•
B		+	;	K	[k	{	ï	ø	½					Ü	1
C		,	<	L	\	l		î	£	¼					ı	3
D		-	=	M]	m	}	ı	Ø	ı	¢			ı	ÿ	2
E		.	>	N	^	n	~	Ä	Ş	«	¥			ı	-	■
F		/	?	O	_	o		Å	ş	»			α			

When Japanese message is selected in the system mode, code 5CH indicates “¥”.
The Euro code (B0H) can be changed in the parameter setting in the system mode.

(5) PC-851

	0	1	2	3	4	5	6	7	8	9	A	B	C	D	E	F
0			0	@	P	`	p	Ç				€				
1		!	1	A	Q	a	q	ü								±
2		"	2	B	R	b	r	é								
3		#	3	C	S	c	s	â	ô							
4		\$	4	D	T	d	t	ä	ö							
5		%	5	E	U	e	u	à								§
6		&	6	F	V	f	v		û							
7		'	7	G	W	g	w	ç	ù							ˆ
8		(8	H	X	h	x	ê								°
9)	9	I	Y	i	y	ë	Ö							¨
A		*	:	J	Z	j	z	è	Ü							
B		+	;	K	[k	{	ï		½						
C		,	<	L	\	l		î	£							
D		-	=	M]	m	}									
E		.	>	N	^	n	~	Ä		«						■
F		/	?	O	_	o				»						

When Japanese message is selected in the system mode, code 5CH indicates “¥”.

The Euro code (B0H) can be changed in the parameter setting in the system mode.

(6) PC-855

	0	1	2	3	4	5	6	7	8	9	A	B	C	D	E	F
0			0	@	P	`	p					€				
1		!	1	A	Q	a	q									
2		"	2	B	R	b	r									
3		#	3	C	S	c	s									
4		\$	4	D	T	d	t									
5		%	5	E	U	e	u									
6		&	6	F	V	f	v									
7		'	7	G	W	g	w									
8		(8	H	X	h	x									
9)	9	I	Y	i	y									
A		*	:	J	Z	j	z									
B		+	;	K	[k	{									
C		,	<	L	\	l										
D		-	=	M]	m	}									§
E		.	>	N	^	n	~			«						■
F		/	?	O	_	o				»			¤			

When Japanese message is selected in the system mode, code 5CH indicates “¥”.

The Euro code (B0H) can be changed in the parameter setting in the system mode.

(7) PC-1250

	0	1	2	3	4	5	6	7	8	9	A	B	C	D	E	F
0			0	@	P	`	p				€	Ř	Đ	ř	ď	
1		!	1	A	Q	a	q			˘	±	Á	Ñ	á	ñ	
2		”	2	B	R	b	r			˘	,		Ň	â	ň	
3		#	3	C	S	c	s			Ł	ł		Ó		ó	
4		\$	4	D	T	d	t			¤	´	Ä	Ö	ä	ö	
5		%	5	E	U	e	u			Α	μ	Í	Õ	í	õ	
6		&	6	F	V	f	v			ı	¶	Č	Ö	č	ö	
7		'	7	G	W	g	w			§	·	Ç	x	ç	÷	
8		(8	H	X	h	x			”	,	Č	Ř	č	ř	
9)	9	I	Y	i	y				ą	É	Ů	é	ů	
A		*	:	J	Z	j	z	Š	š	Ş	ş	Ę	Ú	ę	ú	
B		+	;	K	[k	{	Ś	ś	«	»	Ě	Ů	ě	ů	
C		,	<	L	\	l		Ť	ť	¬	Ł	Ě	Ů	ě	ů	
D		-	=	M]	m	}			-	”	Í	Ý	í	ý	
E		.	>	N	^	n	~	Ž	ž	®	Ĭ	Î	T	î	t	
F		/	?	O	_	o	~	Ž	ž	ž		ž	Đ	ß		

When Japanese message is selected in the system mode, code 5CH indicates “¥”.

The Euro code (B0H) can be changed in the parameter setting in the system mode.

(8) PC-1251

	0	1	2	3	4	5	6	7	8	9	A	B	C	D	E	F
0			0	@	P	`	p				€					
1		!	1	A	Q	a	q				±					
2		”	2	B	R	b	r									
3		#	3	C	S	c	s									
4		\$	4	D	T	d	t			¤						
5		%	5	E	U	e	u				μ					
6		&	6	F	V	f	v			ı	¶					
7		'	7	G	W	g	w			§	·					
8		(8	H	X	h	x									
9)	9	I	Y	i	y									
A		*	:	J	Z	j	z									
B		+	;	K	[k	{			«	»					
C		,	<	L	\	l				¬						
D		-	=	M]	m	}			-						
E		.	>	N	^	n	~			®						
F		/	?	O	_	o	~									

When Japanese message is selected in the system mode, code 5CH indicates “¥”.

The Euro code (B0H) can be changed in the parameter setting in the system mode.

(9) PC-1252

	0	1	2	3	4	5	6	7	8	9	A	B	C	D	E	F
0			0	@	P	`	p				€		Đ	à	đ	
1		!	1	A	Q	a	q			ı	±	Á	Ñ	á	ñ	
2		"	2	B	R	b	r				²		Ò	â	ò	
3		#	3	C	S	c	s	f		£	³		Ó		ó	
4		\$	4	D	T	d	t			¤	´	Ä	Ö	ä	ö	
5		%	5	E	U	e	u				µ	Å	Õ	å	õ	
6		&	6	F	V	f	v			ı	¶	Æ	Ö	æ	ö	
7		'	7	G	W	g	w			§		Ç	x	ç	÷	
8		(8	H	X	h	x	^	~	¨		È	Ø	è	ø	
9)	9	I	Y	i	y			¹		É	Ù	é	ù	
A		*	:	J	Z	j	z	Š	š	ª		Ê	Ú	ê	ú	
B		+	;	K	[k	{			«	»	Ë	Û	ë	û	
C		,	<	L	\	l				¬	¼	Ì	Ü	ì	ü	
D		-	=	M]	m	}			-	½	Í	Ý	í	ý	
E		.	>	N	^	n	~	Ž	ž	®		Î		î		
F		/	?	O	_	o				¿		Ï	ß	ï	ÿ	

When Japanese message is selected in the system mode, code 5CH indicates “¥”.

The Euro code (B0H) can be changed in the parameter setting in the system mode.

(10) PC-1253

	0	1	2	3	4	5	6	7	8	9	A	B	C	D	E	F
0			0	@	P	`	p				€					
1		!	1	A	Q	a	q				±					
2		"	2	B	R	b	r				²					
3		#	3	C	S	c	s	f		£	³					
4		\$	4	D	T	d	t			¤						
5		%	5	E	U	e	u				µ					
6		&	6	F	V	f	v			ı	¶					
7		'	7	G	W	g	w			§	.					
8		(8	H	X	h	x			¨						
9)	9	I	Y	i	y									
A		*	:	J	Z	j	z			ª						
B		+	;	K	[k	{			«	»					
C		,	<	L	\	l				¬						
D		-	=	M]	m	}			-	½					
E		.	>	N	^	n	~			®						
F		/	?	O	_	o										

When Japanese message is selected in the system mode, code 5CH indicates “¥”.

The Euro code (B0H) can be changed in the parameter setting in the system mode.

(11) PC-1254

	0	1	2	3	4	5	6	7	8	9	A	B	C	D	E	F
0			0	@	P	`	p				€			à		
1		!	1	A	Q	a	q			ı	±	Á	Ñ	á	ñ	
2		"	2	B	R	b	r				²		Ò	â	ò	
3		#	3	C	S	c	s	f		£	³		Ó		ó	
4		\$	4	D	T	d	t			¤	'	Ä	Ö	ä	ö	
5		%	5	E	U	e	u				µ	Å	Õ	å	õ	
6		&	6	F	V	f	v			ı	¶	Æ	Ö	æ	ö	
7		'	7	G	W	g	w			§	·	Ç	x	ç	÷	
8		(8	H	X	h	x	^	~	¨	,	È	Ø	è	ø	
9)	9	I	Y	i	y				¹	É	Ù	é	ù	
A		*	:	J	Z	j	z	Š	š	a	º	Ê	Ú	ê	ú	
B		+	;	K	[k	{			«	»	Ë	Û	ë	û	
C		,	<	L	\	l				¬	¼	Ì	Ü	ì	ü	
D		-	=	M]	m	}			-	½	Í		í	¹	
E		.	>	N	^	n	~			®		Î	Ş	î	ş	
F		/	?	O	_	o				-	¿	Ï	ß	ï	ÿ	

When Japanese message is selected in the system mode, code 5CH indicates “¥”.

The Euro code (B0H) can be changed in the parameter setting in the system mode.

(12) PC-1257

	0	1	2	3	4	5	6	7	8	9	A	B	C	D	E	F
0			0	@	P	`	p				€	À	Š	ą	š	
1		!	1	A	Q	a	q					±		Ñ		ń
2		"	2	B	R	b	r				²					
3		#	3	C	S	c	s			£	³	Ć	Ó	ć	ó	
4		\$	4	D	T	d	t			¤	'	Ä		ä		
5		%	5	E	U	e	u				µ	Å	Õ	å	õ	
6		&	6	F	V	f	v			ı	¶	E	Ö	e	ö	
7		'	7	G	W	g	w			§	·		x		÷	
8		(8	H	X	h	x			Ø	ø	Č		č		
9)	9	I	Y	i	y				¹	É	Ł	é	ł	
A		*	:	J	Z	j	z					Z	S	z	ś	
B		+	;	K	[k	{			«	»					
C		,	<	L	\	l				¬	¼		Ü		ü	
D		-	=	M]	m	}			-	½		Z		z	
E		.	>	N	^	n	~			®			Z		z	
F		/	?	O	_	o				Æ	æ		ß			

When Japanese message is selected in the system mode, code 5CH indicates “¥”.

The Euro code (B0H) can be changed in the parameter setting in the system mode.

(13) LATIN9

	0	1	2	3	4	5	6	7	8	9	A	B	C	D	E	F
0			0	@	P	`	p				€		Đ	à	ñ	
1		!	1	A	Q	a	q			ı	±	Á	Ñ	á	ò	
2		"	2	B	R	b	r				²		Ò	â	ó	
3		#	3	C	S	c	s			£	³		Ó		ô	
4		\$	4	D	T	d	t			ř	Ž	Ä	Ö	ä	õ	
5		%	5	E	U	e	u				μ	Å	Õ	å	ö	
6		&	6	F	V	f	v			Š	^{3/4}	Æ	Ö	æ	÷	
7		'	7	G	W	g	w			§		Ç	x	ç	ø	
8		(8	H	X	h	x			š	ž	È	Ø	è	ù	
9)	9	I	Y	i	y				¹	É	Ù	é	ú	
A		*	:	J	Z	j	z			a	ø	Ê	Ú	ê	û	
B		+	;	K	[k	{			«	»	Ë	Û	ë	ü	
C		,	<	L	\	l				¬		Ì	Ü	ì	ý	
D		-	=	M]	m	}			-		Í	Ý	í		
E		.	>	N	^	n	~			®		Î		î	ÿ	
F		/	?	O	_	o					¿	İ	ß	ï		

When Japanese message is selected in the system mode, code 5CH indicates “¥”.

The Euro code (B0H) can be changed in the parameter setting in the system mode.

(14) Arabic

	0	1	2	3	4	5	6	7	8	9	A	B	C	D	E	F
0			0	@	P	`	p				€					
1		!	1	A	Q	a	q									
2		"	2	B	R	b	r									
3		#	3	C	S	c	s									
4		\$	4	D	T	d	t									
5		%	5	E	U	e	u									
6		&	6	F	V	f	v									
7		'	7	G	W	g	w									
8		(8	H	X	h	x									
9)	9	I	Y	i	y									
A		*	:	J	Z	j	z									
B		+	;	K	[k	{									
C		,	<	L	\	l										
D		-	=	M]	m	}									
E		.	>	N	^	n	~									
F		/	?	O	_	o										

When Japanese message is selected in the system mode, code 5CH indicates “¥”.

The Euro code (B0H) can be changed in the parameter setting in the system mode.

12.8 GB2312-80 (CHINESE KANJI) (16×16, 24×24, 32×32, 48×48)

(1) GB2312-80 (Chinese Kanji)

	0	1	2	3	4	5	6	7	8	9	A	B	C	D	E	F
0				0	@	P	`	p								
1			!	1	A	Q	a	q								
2			”	2	B	R	b	r								
3			#	3	C	S	c	s								
4			\$	4	D	T	d	t								
5			%	5	E	U	e	u								
6			&	6	F	V	f	v								
7			'	7	G	W	g	w								
8			(8	H	X	h	x								
9)	9	I	Y	i	y								
A			*	:	J	Z	j	z								
B			+	;	K	[k	{								
C			,	<	L	¥	l									
D			-	=	M]	m	}								
E			.	>	N	^	n	~								
F			/	?	O	_	o									

(2) GB2312-80 code tables

TBD

TBD

TBD

TBD

12.9 TrueType FONT

(1) PC-850

	2	3	4	5	6	7	8	9	A	B	C	D	E	F
0	0	@	P	`	p	Ç	É	á	⋮	⊥	ø	Ó	-	
1	!	1	A	Q	a	q	ü	æ	í	⊗	⊥	Ð	β	±
2	"	2	B	R	b	r	é	Æ	ó	⊗	⊥	Ê	Ô	=
3	#	3	C	S	c	s	â	ô	ú		⊥	Ë	Ò	¼
4	\$	4	D	T	d	t	ä	ö	ñ	⊥	—	È	õ	¶
5	%	5	E	U	e	u	à	ò	Ñ	Á	+	ı	Õ	§
6	&	6	F	V	f	v	â	û	ª	Â	ã	Í	μ	÷
7	'	7	G	W	g	w	ç	ù	º	À	Ã	Î	þ	,
8	(8	H	X	h	x	ê	ÿ	¿	©	⊥	İ	þ	°
9)	9	I	Y	i	y	ë	Ö	®	⊥	⊥	⊥	Ú	¨
A	*	:	J	Z	j	z	è	Û	¬		⊥	⊥	Û	·
B	+	;	K	[k	{	ï	ø	½	⊥	⊥	■	Û	¹
C	,	<	L	\	l		î	£	¼	⊥	⊥	■	ý	³
D	-	=	M]	m	}	ì	Ø	ı	⊥	⊥	⊥	Ý	²
E	.	>	N	^	n	~	Ä	×	«	¥	⊥	⊥	ı	▪
F	/	?	O	_	o	△	Å	f	»	⊥	⊥	■	'	

(2) PC-8

	2	3	4	5	6	7	8	9	A	B	C	D	E	F
0	0	@	P	`	p	Ç	É	á	⋮	⊥	⊥	α	≡	
1	!	1	A	Q	a	q	ü	æ	í	⊗	⊥	⊥	β	±
2	"	2	B	R	b	r	é	Æ	ó	⊗	⊥	⊥	Γ	≥
3	#	3	C	S	c	s	â	ô	ú		⊥	⊥	π	≤
4	\$	4	D	T	d	t	ä	ö	ñ	⊥	—	⊥	Σ	∫
5	%	5	E	U	e	u	à	ò	Ñ	⊥	+	⊥	σ	∫
6	&	6	F	V	f	v	â	û	ª	⊥	⊥	⊥	μ	÷
7	'	7	G	W	g	w	ç	ù	º	⊥	⊥	⊥	τ	≈
8	(8	H	X	h	x	ê	ÿ	¿	⊥	⊥	⊥	Φ	°
9)	9	I	Y	i	y	ë	Ö	⊥	⊥	⊥	⊥	Θ	·
A	*	:	J	Z	j	z	è	Û	¬		⊥	⊥	Ω	·
B	+	;	K	[k	{	ï	ø	½	⊥	⊥	■	δ	√
C	,	<	L	\	l		î	£	¼	⊥	⊥	■	∞	n
D	-	=	M]	m	}	ì	¥	ı	⊥	⊥	■	φ	²
E	.	>	N	^	n	~	Ä	Pt	«	⊥	⊥	⊥	ε	▪
F	/	?	O	_	o	△	Å	f	»	⊥	⊥	■	∩	

(3) PC-852

	2	3	4	5	6	7	8	9	A	B	C	D	E	F
0	0	@	P	`	p	Ç	É	á	⋮	↳	đ	Ó	-	
1	!	1	A	Q	a	q	ü	Í	í	⊞	±	Đ	β	˜
2	"	2	B	R	b	r	é	Í	ó	⊞	±	Đ	Ô	˘
3	#	3	C	S	c	s	â	ô	ú		↳	Ë	Ń	˘
4	\$	4	D	T	d	t	ä	ö	À	↳	—	đ	ń	˘
5	%	5	E	U	e	u	û	L	ą	Á	+	Ń	ń	§
6	&	6	F	V	f	v	é	ŀ	Ž	Â	Ă	Í	Š	÷
7	'	7	G	W	g	w	ç	Ś	ż	Ě	ā	Ī	ś	,
8	(8	H	X	h	x	ł	ś	Ę	Ş	↳	č	Ř	°
9)	9	I	Y	i	y	ë	Ö	ę	↳	↳	↳	Ú	˘
A	*	:	J	Z	j	z	Ő	Ü			↳	↳	↳	·
B	+	;	K	[k	{	ó	Ť	ž	↳	↳	↳	↳	·
C	,	<	L	\	l		í	ť	Č	↳	↳	↳	↳	·
D	-	=	M]	m	}	Ž	Ł	ş	Ž	=	↳	↳	·
E	.	>	N	^	n	˘	Ä	×	«	z	↳	↳	↳	·
F	/	?	O	_	o	△	Ć	č	»	↳	↳	↳	↳	·

(4) PC-857

	2	3	4	5	6	7	8	9	A	B	C	D	E	F
0	0	@	P	`	p	Ç	É	á	⋮	↳	°	Ó	-	
1	!	1	A	Q	a	q	ü	æ	í	⊞	±	ª	β	±
2	"	2	B	R	b	r	é	Æ	ó	⊞	±	Ê	Ô	
3	#	3	C	S	c	s	â	ô	ú		↳	Ë	Ò	¼
4	\$	4	D	T	d	t	ä	ö	ñ	↳	—	È	ø	¶
5	%	5	E	U	e	u	à	ò	Ñ	Á	+	↳	↳	·
6	&	6	F	V	f	v	á	ú	Ğ	Â	ă	Í	μ	÷
7	'	7	G	W	g	w	ç	ù	ğ	À	Ă	Ī		,
8	(8	H	X	h	x	é	İ	ı	°	↳	↳	↳	·
9)	9	I	Y	i	y	ë	Ö	®	↳	↳	↳	↳	·
A	*	:	J	Z	j	z	è	Ü	↳		↳	↳	↳	·
B	+	;	K	[k	{	ï	ø	½	↳	↳	↳	↳	·
C	,	<	L	\	l		î	£	¼	↳	↳	↳	↳	·
D	-	=	M]	m	}	ı	Ø	ı	ç	=	↳	↳	·
E	.	>	N	^	n	˘	Ä	Ş	«	↳	↳	↳	↳	·
F	/	?	O	_	o	△	Å	ş	»	↳	↳	↳	↳	·

(5) PC-851

	2	3	4	5	6	7	8	9	A	B	C	D	E	F
0	0	@	P	`	p	Ç	I	ï	⋮	└	Т	ζ	-	
1	!	l	A	Q	a	q	ü	ï	⊗	└	Y	η	±	
2	"	2	B	R	b	r	é	Ó	ó	⊞	└	Φ	θ	υ
3	#	3	C	S	c	s	â	ô	ú		└	X	ι	φ
4	\$	4	D	T	d	t	ä	ö	Ä	└	—	Ψ	κ	χ
5	%	5	E	U	e	u	à	Y	B	K	+	Ω	λ	§
6	&	6	F	V	f	v	À	ù	Γ	Λ	Π	α	μ	ψ
7	'	7	G	W	g	w	ç	ù	Δ	M	P	β	ν	,
8	(8	H	X	h	x	ê	Ω	E	N	⊞	γ	ξ	°
9)	9	I	Y	i	y	ë	Ö	Z	⊞	⊞	└	o	¨
A	*	:	J	Z	j	z	è	Ü	H		⊞	└	π	ω
B	+	;	K	[k	{	ï	á	½	⊞	⊞	■	ρ	ü
C	,	<	L	\	l		î	£	Θ	⊞	⊞	■	σ	ü
D	-	=	M]	m	}	È	é	I	Ξ	=	δ	ς	ώ
E	.	>	N	^	n	~	Ä	ñ	<	O	⊞	ε	τ	■
F	/	?	O	_	o	△	‘	H	í	»	└	Σ	■	'

(6) PC-855

	2	3	4	5	6	7	8	9	A	B	C	D	E	F
0	0	@	P	`	p	ђ	љ	а	⋮	└	л	Я	-	
1	!	l	A	Q	a	q	Ђ	Љ	А	⊗	└	Л	р	ы
2	"	2	B	R	b	r	ђ	њ	б	⊞	└	М	Р	Ы
3	#	3	C	S	c	s	Ѓ	Њ	Б		└	М	с	з
4	\$	4	D	T	d	t	ѐ	ћ	ц	└	—	н	С	З
5	%	5	E	U	e	u	Ë	ћ	Ц	x	+	Н	т	ш
6	&	6	F	V	f	v	є	ќ	д	X	к	о	Т	Ш
7	'	7	G	W	g	w	Є	Ќ	Д	и	К	О	у	э
8	(8	H	X	h	x	s	ÿ	е	И	⊞	п	У	Э
9)	9	I	Y	i	y	S	Ÿ	E	⊞	⊞	└	ж	щ
A	*	:	J	Z	j	z	i	ц	ф		⊞	└	Ж	Щ
B	+	;	K	[k	{	l	ц	Ф	⊞	⊞	■	в	ч
C	,	<	L	\	l		ï	ю	г	⊞	⊞	■	В	Ч
D	-	=	M]	m	}	İ	Ю	Г	й	=	П	ь	§
E	.	>	N	^	n	~	j	ь	«	Й	⊞	я	Ь	■
F	/	?	O	_	o	△	J	Ђ	»	└	□	■	№	

(7) PC-1250

	2	3	4	5	6	7	8	9	A	B	C	D	E	F
0		0	@	P	`	p	€		°	Ř	Đ	ř	đ	
1	!	1	A	Q	a	q		´	˘	±	Á	Ñ	á	ñ
2	"	2	B	R	b	r	,	'	˘	˘	Á	Ñ	á	ñ
3	#	3	C	S	c	s		“	Ł	ł	Ǻ	Ó	ǻ	ó
4	\$	4	D	T	d	t	„	”	□	´	Ä	Ö	ä	ö
5	%	5	E	U	e	u	...	•	Α	μ	Λ	Ό	ί	ο
6	&	6	F	V	f	v	†	-		¶	Ć	Ö	ć	ö
7	'	7	G	W	g	w	‡	—	§	·	Ç	×	ç	÷
8	(8	H	X	h	x		˙	˙	˙	Č	Ř	č	ř
9)	9	I	Y	i	y	% ^o	™	©	ą	É	Ú	é	ú
A	*	:	J	Z	j	z	Š	š	Ş	ş	Ę	Ú	ę	ú
B	+	;	K	I	k	{	<	>	«	»	Ë	Ú	ë	ú
C	,	<	L	\	l		Ś	ś	¬	Ł	Ě	Ü	ě	ü
D	-	=	M]	m	}	Ť	ť	-	˘	Í	Ý	í	ý
E	.	>	N	^	n	~	Ž	ž	®	Ŧ	İ	Ŧ	ı	ı
F	/	?	O	_	o	⊞	Ž	ž	Ž	ž	Đ	β	đ	·

(8) PC-1251

	2	3	4	5	6	7	8	9	A	B	C	D	E	F
0		0	@	P	`	p	Ђ	ђ	°	А	Р	а	р	
1	!	1	A	Q	a	q	Ѓ	ѓ	˘	Ў	±	Б	С	б
2	"	2	B	R	b	r	,	'	˘	І	В	Т	в	т
3	#	3	C	S	c	s	ѓ	“	Ј	і	Г	У	г	у
4	\$	4	D	T	d	t	„	”	□	г	Д	Ф	д	ф
5	%	5	E	U	e	u	...	•	Г	μ	Е	Х	е	х
6	&	6	F	V	f	v	†	-		¶	Ж	Ц	ж	ц
7	'	7	G	W	g	w	‡	—	§	·	З	Ч	з	ч
8	(8	H	X	h	x	€		Ё	ё	И	Ш	и	ш
9)	9	I	Y	i	y	% ^o	™	©	№	Й	Щ	й	щ
A	*	:	J	Z	j	z	Љ	љ	Є	с	К	Ъ	к	ъ
B	+	;	K	I	k	{	<	>	«	»	Л	Ы	л	ы
C	,	<	L	\	l		Њ	њ	¬	ј	М	Ь	м	ь
D	-	=	M]	m	}	Ќ	ќ	-	Š	Н	Э	н	э
E	.	>	N	^	n	~	Ћ	ћ	®	š	О	Ю	о	ю
F	/	?	O	_	o	⊞	Ц	у	Ї	ї	П	Я	п	я

(9) PC-1252

	2	3	4	5	6	7	8	9	A	B	C	D	E	F
0		0	@	P	`	p	€		°	À	Ð	à	ð	
1	!	1	A	Q	a	q		'	ı	±	Á	Ñ	á	ñ
2	"	2	B	R	b	r	,	'	ç	²	Â	Ò	â	ò
3	#	3	C	S	c	s	f	"	£	³	Ã	Ó	ã	ó
4	\$	4	D	T	d	t	„	"	¤	´	Ä	Ô	ä	ô
5	%	5	E	U	e	u	...	•	¥	µ	Å	Õ	å	õ
6	&	6	F	V	f	v	†	-		¶	Æ	Ö	æ	ö
7	'	7	G	W	g	w	‡	—	§	·	Ç	×	ç	÷
8	(8	H	X	h	x	^	~	"	,	È	Ø	è	ø
9)	9	I	Y	i	y	‰	™	©	¹	É	Ù	é	ù
A	*	:	J	Z	j	z	Š	š	ª	º	Ê	Ú	ê	ú
B	+	;	K	[k	{	<	>	«	»	Ë	Û	ë	û
C	,	<	L	\	l		Œ	œ	¬	¼	Ì	Ü	ì	ü
D	-	=	M]	m	}			-	½	Í	Ý	í	ý
E	.	>	N	^	n	~	Ž	ž	®	¾	Î	Þ	î	þ
F	/	?	O	_	o	☒			ÿ	ˆ	Ï	β	ï	ÿ

(10) PC-1253

	2	3	4	5	6	7	8	9	A	B	C	D	E	F	
0		0	@	P	`	p	€		°	ı	Π	ϖ	π		
1	!	1	A	Q	a	q		'	ˆ	±	Α	Ρ	α	ρ	
2	"	2	B	R	b	r	,	'	Α	²	Β		β	ς	
3	#	3	C	S	c	s	f	"	£	³	Γ	Σ	γ	σ	
4	\$	4	D	T	d	t	„	"	¤	´	Δ	Τ	δ	τ	
5	%	5	E	U	e	u	...	•	¥	µ	Ε	Υ	ε	υ	
6	&	6	F	V	f	v	†	-		¶	Ζ	Φ	ζ	φ	
7	'	7	G	W	g	w	‡	—	§	·	Η	Χ	η	χ	
8	(8	H	X	h	x			"	´	Ε	Θ	Ψ	θ	ψ
9)	9	I	Y	i	y	‰	™	©	¹	Η	Ι	Ω	ι	ω
A	*	:	J	Z	j	z			ª	º	Ι	Κ	ϊ	κ	ϊ
B	+	;	K	[k	{	<	>	«	»	Λ	ÿ	λ	ϖ	
C	,	<	L	\	l				¬	¼	Ο	Μ	ά	μ	ό
D	-	=	M]	m	}			-	½	Ν	έ	ν	ύ	
E	.	>	N	^	n	~			®	¾	Υ	Ξ	ή	ξ	ώ
F	/	?	O	_	o	☒			—	Ω	Ο	ί	ο		

(11) PC-1254

	2	3	4	5	6	7	8	9	A	B	C	D	E	F
0	0	@	P	`	p	€		°	À	Ğ	à	ğ		
1	!	1	A	Q	a	q		·	ı	±	Á	Ñ	á	ñ
2	"	2	B	R	b	r	,	'	ç	²	Â	Ò	â	ò
3	#	3	C	S	c	s	f	“	£	³	Ã	Ó	ã	ó
4	\$	4	D	T	d	t	„	”	□	´	Ä	Ô	ä	ô
5	%	5	E	U	e	u	...	•	¥	μ	Å	Ö	å	ö
6	&	6	F	V	f	v	†	-	‡	¶	Æ	Ö	æ	ö
7	'	7	G	W	g	w	‡	-	§	·	Ç	×	ç	÷
8	(8	H	X	h	x	^	~	¨	.	È	Ø	è	ø
9)	9	I	Y	i	y	‰	™	©	¹	É	Ù	é	ù
A	*	:	J	Z	j	z	Š	š	ª	º	Ê	Ú	ê	ú
B	+	;	K	[k	{	<	>	«	»	Ë	Û	ë	û
C	,	<	L	\	l		Œ	œ	¬	¼	Ì	Û	ì	ü
D	-	=	M]	m	}			-	½	Í	İ	í	ı
E	.	>	N	^	n	~			®	¾	Î	Ş	î	ş
F	/	?	O	_	o	☒		ÿ	ˉ	ı	İ	ß	ï	ÿ

(12) PC-1257

	2	3	4	5	6	7	8	9	A	B	C	D	E	F
0	0	@	P	`	p	€		°	Ą	Ś	ą	ś		
1	!	1	A	Q	a	q		‘		±	Į	Ń	į	ń
2	"	2	B	R	b	r	,	'	ç	²	Ā	Ń	ā	ņ
3	#	3	C	S	c	s		“	£	³	Ć	Ó	ć	ó
4	\$	4	D	T	d	t	„	”	□	´	Ä	Ö	ä	ö
5	%	5	E	U	e	u	...	•		μ	Å	Ö	å	ö
6	&	6	F	V	f	v	†	-	‡	¶	Ę	Ö	ę	ö
7	'	7	G	W	g	w	‡	-	§	·	Ē	×	ē	÷
8	(8	H	X	h	x			Ø	ø	Č	Ů	č	ů
9)	9	I	Y	i	y	‰	™	©	¹	É	Ł	é	ł
A	*	:	J	Z	j	z			Ŕ	ŗ	Ž	Ś	ż	ś
B	+	;	K	[k	{	<	>	«	»	Ē	Ū	ē	ū
C	,	<	L	\	l				¬	¼	Ĝ	Ū	ĝ	ū
D	-	=	M]	m	}	¨	˘	-	½	Ŕ	Ž	ŗ	ż
E	.	>	N	^	n	~	˘	˙	®	¾	Ī	Ž	ī	ž
F	/	?	O	_	o	☒	,		Æ	æ	Ł	ß	ł	·

(13) LATIN9

	2	3	4	5	6	7	8	9	A	B	C	D	E	F
0		0	@	P	`	p			°	À	Ð	à	ð	
1	!	1	A	Q	a	q			ı	±	Á	Ñ	á	ñ
2	"	2	B	R	b	r			¢	²	Â	Ò	â	ò
3	#	3	C	S	c	s			£	³	Ã	Ó	ã	ó
4	\$	4	D	T	d	t			€	Ž	Ä	Ô	ä	ô
5	%	5	E	U	e	u			¥	μ	Å	Ö	å	ö
6	&	6	F	V	f	v			Š	¶	Æ	Ö	æ	ö
7	'	7	G	W	g	w			§	·	Ç	×	ç	÷
8	(8	H	X	h	x			š	ž	È	Ø	è	ø
9)	9	I	Y	i	y			©	¹	É	Ù	é	ù
A	*	:	J	Z	j	z			ª	º	Ê	Ú	ê	ú
B	+	;	K	[k	{			«	»	Ë	Û	ë	û
C	,	<	L	\	l				-	Œ	Ì	Ü	ì	ü
D	-	=	M]	m	}			-	œ	Í	Ý	í	ý
E	.	>	N	^	n	~			®	ÿ	Î	Þ	î	þ
F	/	?	O	_	o	⌘			-	ı	Ï	ß	ï	ÿ

(14) Arabic

	2	3	4	5	6	7	8	9	A	B	C	D	E	F
0		،	ء	ت	ا	ع			ى	ؤ	.	ء		
1	أ	-	=	ث	ل	ع			ل	ى	لا	ء		
2	أ	.	ء	ث	د	ع			ل	ء	لا	ء		
3	أ	/	ء	ج	-	غ			م	ث	لأ	ء		
4		ء	-	ج	ز	ع			م	ئ	لأ	ء		
5	!	ء	ا	س	ج	ع			ن	0	لأ	ء		
6	"	ء	ا	س	ح	ع			هـ	1	لأ	ء	الله	
7	«	ء	أ	س	ح	ع			هـ	2	لأ	ء	ن	
8	»	ء	أ	س	ح	ع			هـ	3	لأ	ء		
9	%	ء	آ	ص	خ	ع			هـ	4	-	ء		
A	x	ء	آ	ص	ح	ع			و	5	-	ء		
B	÷	ء	!	ص	خ	ع			ب	6	ء			
C	(ء	!	د	ض	ع			ي	7	-	ء		
D)	ء	ب	ذ	ط	ع			ي	8	-	ء		
E	*	:	ب	ر	ط	ع			هـ	9	-	ء		
F	+	ء	ت	ل	ع				ئ	.	ء			

13. BAR CODE TABLE

- (1) WPC (JAN, EAN, UPC)
 ITF, MSI, UCC/EAN128, Industrial 2 of 5
 RSS-14/RSS-14 Stacked
 RSS-14 Stacked Omnidirectional
 RSS-14 Limited

	2	3	4	5	6	7
0		0				
1		1				
2		2				
3		3				
4		4				
5		5				
6		6				
7		7				
8		8				
9		9				
A						
B						
C						
D						
E						
F						

- (2) CODE39 (Standard)

	2	3	4	5	6	7
0	SP	0		P		
1		1	A	Q		
2		2	B	R		
3		3	C	S		
4	\$	4	D	T		
5	%	5	E	U		
6		6	F	V		
7		7	G	W		
8		8	H	X		
9		9	I	Y		
A	.		J	Z		
B	+		K			
C			L			
D	-		M			
E	•		N			
F	/		O			

- (3) CODE39 (Full ASCII)

[Transfer code]

	2	3	4	5	6	7
0	SP	0	@	P	`	p
1	!	1	A	Q	a	q
2	"	2	B	R	b	r
3	#	3	C	S	c	s
4	\$	4	D	T	d	t
5	%	5	E	U	e	u
6	&	6	F	V	f	v
7	'	7	G	W	g	w
8	(8	H	X	h	x
9)	9	I	Y	i	y
A	*	:	J	Z	j	z
B	+	;	K	[k	{
C	,	<	L	\	l	
D	-	=	M]	m	}
E	.	>	N	^	n	~
F	/	?	O	_	o	△

[Drawing code]

	2	3	4	5	6	7
0	SP	0	%V	P	%W	+P
1	/A	1	A	Q	+A	+Q
2	/B	2	B	R	+B	+R
3	/C	3	C	S	+C	+S
4	/D	4	D	T	+D	+T
5	/E	5	E	U	+E	+U
6	/F	6	F	V	+F	+V
7	/G	7	G	W	+G	+W
8	/H	8	H	X	+H	+X
9	/I	9	I	Y	+I	+Y
A	/J	/Z	J	Z	+J	+Z
B	/K	%F	K	%K	+K	%P
C	/L	%G	L	%L	+L	%Q
D	-	%H	M	%M	+M	%R
E	.	%I	N	%N	+N	%S
F	/O	%J	O	%O	+O	%T



(4) NW-7

	2	3	4	5	6	7
0	SP	0				
1		1	A		a	
2		2	B		b	
3		3	C		c	
4	\$	4	D		d	t
5		5			e	
6		6				
7		7				
8		8				
9		9				
A	*	:				
B	+					
C						
D	-					
E	•				n	
F	/					

(5) CODE93

[Transfer code]

	2	3	4	5	6	7
0	SP	0	@	P	`	p
1	!	1	A	Q	a	q
2	"	2	B	R	b	r
3	#	3	C	S	c	s
4	\$	4	D	T	d	t
5	%	5	E	U	e	u
6	&	6	F	V	f	v
7	'	7	G	W	g	w
8	(8	H	X	h	x
9)	9	I	Y	i	y
A	*	:	J	Z	j	z
B	+	;	K	[k	{
C	,	<	L	\	l	
D	-	=	M]	m	}
E	.	>	N	^	n	~
F	/	?	O	_	o	△



[Drawing code]

	2	3	4	5	6	7
0	SP	0	%V	P	%W	+P
1	/A	1	A	Q	+A	+Q
2	/B	2	B	R	+B	+R
3	/C	3	C	S	+C	+S
4	/D	4	D	T	+D	+T
5	/E	5	E	U	+E	+U
6	/F	6	F	V	+F	+V
7	/G	7	G	W	+G	+W
8	/H	8	H	X	+H	+X
9	/I	9	I	Y	+I	+Y
A	/J	/Z	J	Z	+J	+Z
B	+	%F	K	%K	+K	%P
C	/L	%G	L	%L	+L	%Q
D	-	%H	M	%M	+M	%R
E	.	%I	N	%N	+N	%S
F	/	%J	O	%O	+O	%T

(6) CODE128

[Transfer code]

	-	-	2	3	4	5	6	7
0	NUL	DLE	SP	0	@	P	`	p
1	SOH	DC1	!	1	A	Q	a	q
2	STX	DC2	"	2	B	R	b	r
3	ETX	DC3	#	3	C	S	c	s
4	EOT	DC4	\$	4	D	T	d	t
5	ENQ	NAK	%	5	E	U	e	u
6	ACK	SYN	&	6	F	V	f	v
7	BEL	ETB	'	7	G	W	g	w
8	BS	CAN	(8	H	X	h	x
9	HT	EM)	9	I	Y	i	y
A	LF	SUB	*	:	J	Z	j	z
B	VT	ESC	+	;	K	[k	{
C	FF	FS	,	<	L	\	l	
D	CR	GS	-	=	M]	m	}
E	SO	RS	.	>	N	^	n	~
F	SI	US	/	?	O	_	o	△



[Drawing code]

Value Code Table

① How to transmit control code data:

NUL (00H) → >@ (3EH, 40H)
 SOH (01H) → >A (3EH, 41H)
 STX (02H) → >B (3EH, 42H)
 to
 GS (1DH) → >] (3EH, 5DH)
 RS (1EH) → >^ (3EH, 5EH)
 US (1FH) → >_ (3EH, 5FH)

② How to transmit special codes:

Value
 30 (Character >) → >0
 95 → >1
 96 → >2
 97 → >3
 98 → >4
 99 → >5
 100 → >6
 101 → >7
 102 → >8

③ Designation of start code:

START (CODE A) → >7
 START (CODE B) → >6
 START (CODE C) → >5

Value Code Table

VALUE	CODE A	CODE B	CODE C
0	SP	SP	00
1	!	!	01
2	"	"	02
3	#	#	03
4	\$	\$	04
5	%	%	05
6	&	&	06
7	'	'	07
8	((08
9))	09
10	*	*	10
11	+	+	11
12	,	,	12
13	-	-	13
14	.	.	14
15	/	/	15
16	0	0	16
17	1	1	17
18	2	2	18
19	3	3	19
20	4	4	20
21	5	5	21
22	6	6	22
23	7	7	23
24	8	8	24
25	9	9	25
26	:	:	26
27	;	;	27
28	<	<	28
29	=	=	29
30	>	>	30
31	?	?	31
32	@	@	32
33	A	A	33
34	B	B	34
35	C	C	35

VALUE	CODE A	CODE B	CODE C
36	D	D	36
37	E	E	37
38	F	F	38
39	G	G	39
40	H	H	40
41	I	I	41
42	J	J	42
43	K	K	43
44	L	L	44
45	M	M	45
46	N	N	46
47	O	O	47
48	P	P	48
49	Q	Q	49
50	R	R	50
51	S	S	51
52	T	T	52
53	U	U	53
54	V	V	54
55	W	W	55
56	X	X	56
57	Y	Y	57
58	Z	Z	58
59	[[59
60	\	\	60
61]]	61
62	^	^	62
63	_	_	63
64	NUL	`	64
65	SOH	a	65
66	STX	b	66
67	ETX	c	67
68	EOT	d	68
69	ENQ	e	69
70	ACK	f	70
71	BEL	g	71

VALUE	CODE A	CODE B	CODE C
72	BS	h	72
73	HT	i	73
74	LF	j	74
75	VT	k	75
76	FF	l	76
77	CR	m	77
78	SO	n	78
79	SI	o	79
80	DLE	p	80
81	DC1	q	81
82	DC2	r	82
83	DC3	s	83
84	DC4	t	84
85	NAK	u	85
86	SYN	v	86
87	ETB	w	87
88	CAN	x	88
89	EM	y	89
90	SUB	z	90
91	ESC	{	91
92	FS		92
93	GS	}	93
94	RS	~	94
95	US	DEL	95
96	FNC3	FNC3	96
97	FNC2	FNC2	97
98	SHIFT	SHIFT	98
99	CODE C	CODE C	99
100	CODE B	FNC4	CODE B
101	FNC4	CODE A	CODE A
102	FNC1	FNC1	FNC1

103	START CODE A
104	START CODE B
105	START CODE C

(7) Data Matrix

The code to be used is designated using the format ID.

Format ID	Code	Details
1	Numerics	0 to 9 space
2	Letters	A to Z space
3	Alphanumerics, symbols	0 to 9 A to Z space . , - /
4	Alphanumerics	0 to 9 A to Z space
5	ASCII (7-bit)	00H to 7FH
6	ISO (8-bit)	00H to FFH (Kanji)

[Transfer Code]

	0	1	2	3	4	5	6	7	8	9	A	B	C	D	E	F
0	NUL	DLE	SP	0	@	P	`	p								
1	SOH	DC1	!	1	A	Q	a	q								
2	STX	DC2	"	2	B	R	b	r								
3	ETX	DC3	#	3	C	S	c	s								
4	EOT	DC4	\$	4	D	T	d	t								
5	ENQ	NAK	%	5	E	U	e	u								
6	ACK	SYN	&	6	F	V	f	v								
7	BEL	ETB	'	7	G	W	g	w								
8	BS	CAN	(8	H	X	h	x								
9	HT	EM)	9	I	Y	i	y								
A	LF	SUB	*	:	J	Z	j	z								
B	VT	ESC	+	;	K	[k	{								
C	FF	FS	,	<	L	\	l									
D	CR	GS	-	=	M]	m	}								
E	SO	RS	.	>	N	^	n	~								
F	SI	US	/	?	O	_	o	△								

① How to send control code data:

NUL (00H) → >@ (3EH, 40H)
 SOH (01H) → >A (3EH, 41H)
 STX (02H) → >B (3EH, 42H)
 to
 GS (1DH) → >] (3EH, 5DH)
 RS (1EH) → >^ (3EH, 5EH)
 US (1FH) → >_ (3EH, 5FH)

② How to send a special code:

> (3EH) → >0 (3EH, 30H)

③ How to send a Kanji code:

Shift JIS

JIS hexadecimal

(For details, refer to the section for the Bar Code Data Command.)

(8) PDF417

The following modes are automatically selected according to the code used.

Mode	Code	Details
EXC mode	Alphanumerics, symbol	0 to 9 A to Z a to z space ! " # \$ % & ' () * + , - . / : ; < = > ? @ [\] ^ _ ` { } ^ ~ CR HT
Binary/ASCII Plus mode	Binary International Character Set	00H to FFH (Kanji)
Numeric Compaction mode	Numerics	0 to 9

[Transfer Code]

	0	1	2	3	4	5	6	7	8	9	A	B	C	D	E	F
0	NUL	DLE	SP	0	@	P	`	p								
1	SOH	DC1	!	1	A	Q	a	q								
2	STX	DC2	"	2	B	R	b	r								
3	ETX	DC3	#	3	C	S	c	s								
4	EOT	DC4	\$	4	D	T	d	t								
5	ENQ	NAK	%	5	E	U	e	u								
6	ACK	SYN	&	6	F	V	f	v								
7	BEL	ETB	'	7	G	W	g	w								
8	BS	CAN	(8	H	X	h	x								
9	HT	EM)	9	I	Y	i	y								
A	LF	SUB	*	:	J	Z	j	z								
B	VT	ESC	+	;	K	[k	{								
C	FF	FS	,	<	L	\	l									
D	CR	GS	-	=	M]	m	}								
E	SO	RS	.	>	N	^	n	~								
F	SI	US	/	?	O	_	o	△								

① How to send control code data:

NUL (00H) → >@ (3EH, 40H)
 SOH (01H) → >A (3EH, 41H)
 STX (02H) → >B (3EH, 42H)
 to
 GS (1DH) → >] (3EH, 5DH)
 RS (1EH) → >^ (3EH, 5EH)
 US (1FH) → >_ (3EH, 5FH)

② How to send a special code:

> (3EH) → >0 (3EH, 30H)

③ How to send a Kanji code:

Shift JIS

JIS hexadecimal

(For details, refer to the section for the Bar Code Data Command.)

(9) MicroPDF417

The following modes are automatically selected according to the code used.

Mode	Details
Upper case letters, space	A to Z, space
Binary International Character Set	00H to FFH (Kanji)
Numerics	0 to 9

[Transfer Code]

	0	1	2	3	4	5	6	7	8	9	A	B	C	D	E	F
0	NUL	DLE	SP	0	@	P	`	p								
1	SOH	DC1	!	1	A	Q	a	q								
2	STX	DC2	"	2	B	R	b	r								
3	ETX	DC3	#	3	C	S	c	s								
4	EOT	DC4	\$	4	D	T	d	t								
5	ENQ	NAK	%	5	E	U	e	u								
6	ACK	SYN	&	6	F	V	f	v								
7	BEL	ETB	'	7	G	W	g	w								
8	BS	CAN	(8	H	X	h	x								
9	HT	EM)	9	I	Y	i	y								
A	LF	SUB	*	:	J	Z	j	z								
B	VT	ESC	+	;	K	[k	{								
C	FF	FS	,	<	L	\	l									
D	CR	GS	-	=	M]	m	}								
E	SO	RS	.	>	N	^	n	~								
F	SI	US	/	?	O	_	o	△								

① How to send control code data:

NUL (00H) → >@ (3EH, 40H)
 SOH (01H) → >A (3EH, 41H)
 STX (02H) → >B (3EH, 42H)
 to
 GS (1DH) → >] (3EH, 5DH)
 RS (1EH) → >^ (3EH, 5EH)
 US (1FH) → >_ (3EH, 5FH)

② How to send a special code:

> (3EH) → >0 (3EH, 30H)

③ How to send a Kanji code:

Shift JIS

JIS hexadecimal

(For details, refer to the section for the Bar Code Data Command.)

(10) QR code

When manual mode is selected in the Format Command

- Numeric mode, alphanumeric and symbol mode, Kanji mode

Mode selection	Data to be printed
----------------	--------------------

- Binary mode

Mode selection	No. of data strings (4 digits)	Data to be printed
----------------	-----------------------------------	--------------------

- Mixed mode

Data	“,” (comma)	Data	“,” (comma)	Data
------	-------------	------	-------------	------

The QR code can handle all codes including alphanumerics, symbols, and Kanji. However, since the data compression rate varies according to codes, the code to be used should be designated by selecting the mode.

Mode	Code	Details
N	Numerals	0 to 9
A	Alphanumerics, symbols	A to Z 0 to 9 space \$ % * + - . / :
B	Binary (8-bit)	00H to FFH
K	Kanji	Shift JIS, JIS hexadecimal

If mixed mode is selected, up to 200 modes can be selected in a QR code.

When the automatic mode is selected in the Format Command for a QR code:

Data to be printed

[Transfer code for QR code]

	0	1	2	3	4	5	6	7	8	9	A	B	C	D	E	F
0	NUL	DLE	SP	0	@	P	`	p								
1	SOH	DC1	!	1	A	Q	a	q								
2	STX	DC2	"	2	B	R	b	r								
3	ETX	DC3	#	3	C	S	c	s								
4	EOT	DC4	\$	4	D	T	d	t								
5	ENQ	NAK	%	5	E	U	e	u								
6	ACK	SYN	&	6	F	V	f	v								
7	BEL	ETB	'	7	G	W	g	w								
8	BS	CAN	(8	H	X	h	x								
9	HT	EM)	9	I	Y	i	y								
A	LF	SUB	*	:	J	Z	j	z								
B	VT	ESC	+	;	K	[k	{								
C	FF	FS	,	<	L	\	l									
D	CR	GS	-	=	M]	m	}								
E	SO	RS	•	>	N	^	n	~								
F	SI	US	/	?	O	_	o	DEL								

* The shaded parts are Japanese. They are omitted here.

① How to send control code data:

NUL (00H) → >@ (3EH, 40H)
 SOH (01H) → >A (3EH, 41H)
 STX (02H) → >B (3EH, 42H)
 to
 GS (1DH) → >] (3EH, 5DH)
 RS (1EH) → >^ (3EH, 5EH)
 US (1FH) → >_ (3EH, 5FH)

② How to send a special code:

> (3EH) → >0 (3EH, 30H)

③ How to send a Kanji code:

Shift JIS
 JIS hexadecimal
 (For details, refer to the section for the Bar Code Data Command.)

Examples of data designation for QR code

① Alphanumeric mode: ABC123

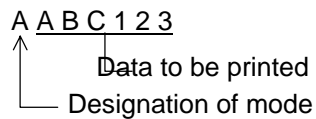

② Binary mode: 01H, 03H, 05H

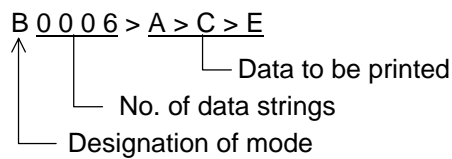

③ Mixed mode

Numeric mode : 123456
 Kanji mode : Kanji data
 Binary mode : a ア i イ u ウ e エ o オ
 Alphanumeric and symbol mode : ABC

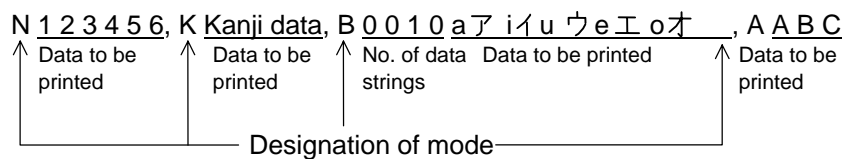

④ Automatic mode

When the same data as ③ above is designated in automatic mode:

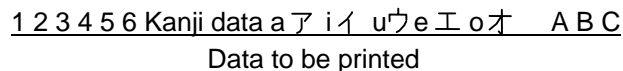

(11) Postal code

Customer bar code

	2	3	4	5	6	7
0		0		P		
1		1	A	Q		
2		2	B	R		
3		3	C	S		
4		4	D	T		
5		5	E	U		
6		6	F	V		
7		7	G	W		
8		8	H	X		
9		9	I	Y		
A			J	Z		
B			K			
C			L			
D	-		M			
E			N			
F			O			

POSTNET

	2	3	4	5	6	7
0		0				
1		1				
2		2				
3		3				
4		4				
5		5				
6		6				
7		7				
8		8				
9		9				
A						
B						
C						
D						
E						
F						

RM4SCC

	2	3	4	5	6	7
0		0		P		
1		1	A	Q		
2		2	B	R		
3		3	C	S		
4		4	D	T		
5		5	E	U		
6		6	F	V		
7		7	G	W		
8	(8	H	X		
9)	9	I	Y		
A			J	Z		
B			K			
C			L			
D			M			
E			N			
F			O			

KIX CODE

	2	3	4	5	6	7
0		0		P		p
1		1	A	Q	a	q
2		2	B	R	b	r
3		3	C	S	c	s
4		4	D	T	d	t
5		5	E	U	e	u
6		6	F	V	f	v
7		7	G	W	g	w
8		8	H	X	h	x
9		9	I	Y	i	y
A			J	Z	j	z
B			K		k	
C			L		l	
D			M		m	
E			N		n	
F			O		o	

* (“(” or “)”) can be designated only as a start/stop code.
 These should not be entered in data.
 If these are entered between data, no bar code is drawn.

(12) MaxiCode

Symbol Character Value		Code Set A		Code Set B		Code Set C		Code Set D		Code Set E	
Decimal	Binary	Character	Decimal	Character	Decimal	Character	Decimal	Character	Decimal	Character	Decimal
0	000000	CR	13	'	96	À	192	à	224	NUL	0
1	000001	A	65	a	97	Á	193	á	225	SOH	1
2	000010	B	66	b	98	Â	194	â	226	STX	2
3	000011	C	67	c	99	Ã	195	ã	227	ETX	3
4	000100	D	68	d	100	Ä	196	ä	228	EOT	4
5	000101	E	69	e	101	Å	197	å	229	ENQ	5
6	000110	F	70	f	102	Æ	198	æ	230	ACK	6
7	000111	G	71	g	103	Ç	199	ç	231	BEL	7
8	001000	H	72	h	104	È	200	è	232	BS	8
9	001001	I	73	i	105	É	201	é	233	HT	9
10	001010	J	74	j	106	Ê	202	ê	234	LF	10
11	001011	K	75	k	107	Ë	203	ë	235	VT	11
12	001100	L	76	l	108	Ì	204	ì	236	FF	12
13	001101	M	77	m	109	Í	205	í	237	CR	13
14	001110	N	78	n	110	Î	206	î	238	SO	14
15	001111	O	79	o	111	Ï	207	ï	239	SI	15
16	010000	P	80	p	112	Ð	208	ð	240	DLE	16
17	010001	Q	81	q	113	Ñ	209	ñ	241	DC1	17
18	010010	R	82	r	114	Ò	210	ò	242	DC2	18
19	010011	S	83	s	115	Ó	211	ó	243	DC3	19
20	010100	T	84	t	116	Ô	212	ô	244	DC4	20
21	010101	U	85	u	117	Õ	213	õ	245	NAK	21
22	010110	V	86	v	118	Ö	214	ö	246	SYN	22
23	010111	W	87	w	119	×	215	÷	247	ETB	23
24	011000	X	88	x	120	Ø	216	ø	248	CAN	24
25	011001	Y	89	y	121	Ù	217	ù	249	EM	25
26	011010	Z	90	z	122	Ú	218	ú	250	SUB	26
27	011011	[EC]		[EC]		[EC]		[EC]		[EC]	
28	011100	FS	28	FS	28	FS	28	FS	28	[Pad]	
29	011101	GS	29	GS	29	GS	29	GS	29	[Pad]	
30	011110	RS	30	RS	30	RS	30	RS	30	ESC	27
31	011111	[NS]		[NS]		[NS]		[NS]		[NS]	
32	100000	Space	32	(123	Û	219	û	251	FS	28
33	100001	[Pad])	125	Ü	220	ü	252	GS	29
34	100010	"	34	~	126	Ý	221	ý	253	RS	30
35	100011	#	35	DEL	127	Þ	222	þ	254	US	31
36	100100	\$	36	;	59	Ë	223	ë	255	{C159}	159
37	100101	%	37	<	60	ä	170	ä	161	NBSP	160
38	100110	&	38	=	61	ı	172	ı	168	¢	162
39	100111	'	39	>	62	±	177	«	171	£	163
40	101000	(40	?	63	²	178	-	175	¤	164
41	101001)	41	[91	³	179	°	176	¥	165
42	101010	"	42	\	92	´	181	'	180		166
43	101011	+	43]	93	µ	185	•	183	§	167
44	101100	,	44]	93	°	186	»	184	©	169
45	101101	-	45	^	94	¼	188	»	187	SHY	173
46	101110	.	46	_	95	½	189	¿	191	®	174
47	101111	/	47	Space	32	¾	190	{C138}	138	¶	182
48	110000	0	48	,	44	{C128}	128	{C139}	139	{C149}	149
49	110001	1	49	.	46	{C129}	129	{C140}	140	{C150}	150
50	110010	2	50	/	47	{C130}	130	{C141}	141	{C151}	151
51	110011	3	51	:	58	{C131}	131	{C142}	142	{C152}	152
52	110100	4	52	@	64	{C132}	132	{C143}	143	{C153}	153
53	110101	5	53	!	33	{C133}	133	{C144}	144	{C154}	154
54	110110	6	54		124	{C134}	134	{C145}	145	{C155}	155
55	110111	7	55	[Pad]		{C135}	135	{C146}	146	{C156}	156
56	111000	8	56	[2 Shift A]		{C136}	136	{C147}	147	{C157}	157
57	111001	9	57	[3 Shift A]		{C137}	137	{C148}	148	{C158}	158
58	111010	:	58	[Pad]		[Latch A]		[Latch A]		[Latch A]	
59	111011	[Shift B]		[Shift A]		Space	32	Space	32	Space	32
60	111100	[Shift C]		[Shift C]		[Lock In C]		[Shift C]		[Shift C]	
61	111101	[Shift D]		[Shift D]		[Shift D]		[Lock In D]		[Shift D]	
62	111110	[Shift E]		[Shift E]		[Shift E]		[Shift E]		[Lock In E]	
63	111111	[Latch B]		[Latch A]		[Latch B]		[Latch B]		[Latch B]	

① How to send control code data:

SOH (01H) → >A (3EH, 41H)
 STX (02H) → >B (3EH, 42H)
 to
 GS (1DH) → >] (3EH, 5DH)
 RS (1EH) → >^ (3EH, 5EH)
 US (1FH) → >_ (3EH, 5FH)

② How to send a special code:

> (3EH) → >0 (3EH, 30H)

③ How to send a Kanji code:

Shift JIS
 JIS hexadecimal
 (For details, refer to the section for the Bar Code Data Command.)

NOTE: "NUL" code in the table cannot be used, however, it can be designated.
 If it is designated, data following "NUL" code is not printed.

When the MaxiCode specification setting is set to "TYPE2: Special specification" in the system mode:

[Transfer code for MaxiCode]

	0	1	2	3	4	5	6	7	8	9	A	B	C	D	E	F
0	NUL	DLE	SP	0	@	P	`	p								
1	SOH	DC1	!	1	A	Q	a	q								
2	STX	DC2	"	2	B	R	b	r								
3	ETX	DC3	#	3	C	S	c	s								
4	EOT	DC4	\$	4	D	T	d	t								
5	ENQ	NAK	%	5	E	U	e	u								
6	ACK	SYN	&	6	F	V	f	v								
7	BEL	ETB	'	7	G	W	g	w								
8	BS	CAN	(8	H	X	h	x								
9	HT	EM)	9	I	Y	i	y								
A	LF (Note1)	SUB	*	:	J	Z	j	z								
B	VT	ESC	+	;	K	[k	{								
C	FF	FS	,	<	L	\	l									
D	CR	GS	-	=	M]	m	}								
E	SO	RS	•	>	N	^	n	~								
F	SI	US	/	?	O	_	o	DEL								(Note2)

The all codes (00H to FFH) can be used. In the following cases, however, the codes will become special codes. For the transfer method, refer to the following.

(Note 1) In case of LF (0AH) data:

LF (0AH) → J (FFH, 4AH)

(Note 2) In case of (FFH) data:

(FFH) - (FFH, FFH)

ESC (1BH) and NUL (00H) can be used as they are.

(13) CP code

[Transfer Code]

	0	1	2	3	4	5	6	7	8	9	A	B	C	D	E	F
0	NUL	DLE	SP	0	@	P	`	p								
1	SOH	DC1	!	1	A	Q	a	q								
2	STX	DC2	"	2	B	R	b	r								
3	ETX	DC3	#	3	C	S	c	s								
4	EOT	DC4	\$	4	D	T	d	t								
5	ENQ	NAK	%	5	E	U	e	u								
6	ACK	SYN	&	6	F	V	f	v								
7	BEL	ETB	'	7	G	W	g	w								
8	BS	CAN	(8	H	X	h	x								
9	HT	EM)	9	I	Y	i	y								
A	LF	SUB	*	:	J	Z	j	z								
B	VT	ESC	+	;	K	[k	{								
C	FF	FS	,	<	L	\	l									
D	CR	GS	-	=	M]	m	}								
E	SO	RS	.	>	N	^	n	~								
F	SI	US	/	?	O	_	o	△								

① How to send control code data:

NUL (00H) → >@ (3EH, 40H)
 SOH (01H) → >A (3EH, 41H)
 STX (02H) → >B (3EH, 42H)
 to
 GS (1DH) → >] (3EH, 5DH)
 RS (1EH) → >^ (3EH, 5EH)
 US (1FH) → >_ (3EH, 5FH)

② How to send a special code:

> (3EH) → >0 (3EH, 30H)

③ How to send a Kanji code:

Shift JIS

JIS hexadecimal

(For details, refer to the section for the Bar Code Data Command.)

(14) RSS-14 Expanded

[Transfer Code]

	0	1	2	3	4	5	6	7	8	9	A	B	C	D	E	F
0			SP	0		P		p								
1			!	1	A	Q	a	q								
2			"	2	B	R	b	r								
3			FNC1	3	C	S	c	s								
4				4	D	T	d	t								
5			%	5	E	U	e	u								
6			&	6	F	V	f	v								
7			'	7	G	W	g	w								
8			(8	H	X	h	x								
9)	9	I	Y	i	y								
A			*	:	J	Z	j	z								
B			+	;	K		k									
C			,	<	L		l									
D			-	=	M		m									
E			.	>	N		n									
F			/	?	O	_	o									

(15) RFID

[Transfer Code]

	0	1	2	3	4	5	6	7	8	9	A	B	C	D	E	F
0	NUL	DLE	SP	0	@	P	`	p								
1	SOH	DC1	!	1	A	Q	a	q								
2	STX	DC2	"	2	B	R	b	r								
3	ETX	DC3	#	3	C	S	c	s								
4	EOT	DC4	\$	4	D	T	d	t								
5	ENQ	NAK	%	5	E	U	e	u								
6	ACK	SYN	&	6	F	V	f	v								
7	BEL	ETB	'	7	G	W	g	w								
8	BS	CAN	(8	H	X	h	x								
9	HT	EM)	9	I	Y	i	y								
A	LF ^(*)	SUB	*	:	J	Z	j	z								
B	VT	ESC	+	;	K	[k	{								
C	FF	FS	,	<	L	\	l									
D	CR	GS	-	=	M]	m	}								
E	SO	RS	.	>	N	^	n	~								
F	SI	US	/	?	O	_	o	DEL								

All codes can be used. (00H to FFH)

① How to send control code data:

NUL (00H) → >@ (3EH, 40H)
SOH (01H) → >A (3EH, 41H)
STX (02H) → >B (3EH, 42H)
to
GS (1DH) → >] (3EH, 5DH)
RS (1EH) → >^ (3EH, 5EH)
US (1FH) → >_ (3EH, 5FH)

② How to send a special code:

>(3EH) → >0 (3EH, 30H)

14. DRAWING OF BAR CODE DATA

————— : Field to be incremented/decremented
(The absence of a solid line invalidates incrementing/decrementing.)

————— : Field subject to printing numerals under bars.

Type of Bar Code: JAN8, EAN8

(1) No affix

No. of Input Digits										
8 digits	Input Data	<table border="1" style="display: inline-table; border-collapse: collapse;"> <tr> <td>D₁</td><td>D₂</td><td>D₃</td><td>D₄</td><td>D₅</td><td>D₆</td><td>D₇</td><td>D₈</td> </tr> </table> <div style="text-align: right; margin-right: 100px;"> To be checked as modulus 10 C/D </div>	D ₁	D ₂	D ₃	D ₄	D ₅	D ₆	D ₇	D ₈
	D ₁	D ₂	D ₃	D ₄	D ₅	D ₆	D ₇	D ₈		
Drawing Data	<table border="1" style="display: inline-table; border-collapse: collapse;"> <tr> <td>D₁</td><td>D₂</td><td>D₃</td><td>D₄</td><td>D₅</td><td>D₆</td><td>D₇</td><td>D₈</td> </tr> </table>	D ₁	D ₂	D ₃	D ₄	D ₅	D ₆	D ₇	D ₈	
D ₁	D ₂	D ₃	D ₄	D ₅	D ₆	D ₇	D ₈			
Other than 8 digits		Not to be drawn								

(2) Modulus 10 check

No. of Input Digits										
8 digits	Input Data	<table border="1" style="display: inline-table; border-collapse: collapse;"> <tr> <td>D₁</td><td>D₂</td><td>D₃</td><td>D₄</td><td>D₅</td><td>D₆</td><td>D₇</td><td>D₈</td> </tr> </table> <div style="text-align: right; margin-right: 100px;"> To be checked as modulus 10 C/D </div>	D ₁	D ₂	D ₃	D ₄	D ₅	D ₆	D ₇	D ₈
	D ₁	D ₂	D ₃	D ₄	D ₅	D ₆	D ₇	D ₈		
Drawing Data	<table border="1" style="display: inline-table; border-collapse: collapse;"> <tr> <td>D₁</td><td>D₂</td><td>D₃</td><td>D₄</td><td>D₅</td><td>D₆</td><td>D₇</td><td>D₈</td> </tr> </table>	D ₁	D ₂	D ₃	D ₄	D ₅	D ₆	D ₇	D ₈	
D ₁	D ₂	D ₃	D ₄	D ₅	D ₆	D ₇	D ₈			
Other than 8 digits		Not to be drawn								

(3) Auto affix of modulus 10

No. of Input Digits									
7 digits	Input Data	<table border="1" style="display: inline-table; border-collapse: collapse;"> <tr> <td>D₁</td><td>D₂</td><td>D₃</td><td>D₄</td><td>D₅</td><td>D₆</td><td>D₇</td> </tr> </table>	D ₁	D ₂	D ₃	D ₄	D ₅	D ₆	D ₇
	D ₁	D ₂	D ₃	D ₄	D ₅	D ₆	D ₇		
Drawing Data	<table border="1" style="display: inline-table; border-collapse: collapse;"> <tr> <td>D₁</td><td>D₂</td><td>D₃</td><td>D₄</td><td>D₅</td><td>D₆</td><td>D₇</td><td>C/D</td> </tr> </table> <div style="text-align: right; margin-right: 100px;"> Affix a modulus 10 C/D. </div>	D ₁	D ₂	D ₃	D ₄	D ₅	D ₆	D ₇	C/D
D ₁	D ₂	D ₃	D ₄	D ₅	D ₆	D ₇	C/D		
Other than 7 digits		Not to be drawn							

Type of Bar Code: JAN13, EAN13

(1) No affix

No. of Input Digits		
13 digits	Input Data	D ₁ D ₂ D ₃ D ₄ D ₅ D ₆ D ₇ D ₈ D ₉ D ₁₀ D ₁₁ D ₁₂ D ₁₃ To be checked as modulus 10 C/D
	Drawing Data	D ₂ D ₃ D ₄ D ₅ D ₆ D ₇ D ₈ D ₉ D ₁₀ D ₁₁ D ₁₂ D ₁₃
Other than 13 digits		Not to be drawn

(2) Modulus 10 check

No. of Input Digits		
13 digits	Input Data	D ₁ D ₂ D ₃ D ₄ D ₅ D ₆ D ₇ D ₈ D ₉ D ₁₀ D ₁₁ D ₁₂ D ₁₃ To be checked as modulus 10 C/D
	Drawing Data	D ₂ D ₃ D ₄ D ₅ D ₆ D ₇ D ₈ D ₉ D ₁₀ D ₁₁ D ₁₂ D ₁₃
Other than 13 digits		Not to be drawn

(3) Auto affix of modulus 10

No. of Input Digits		
12 digits	Input Data	D ₁ D ₂ D ₃ D ₄ D ₅ D ₆ D ₇ D ₈ D ₉ D ₁₀ D ₁₁ D ₁₂
	Drawing Data	D ₂ D ₃ D ₄ D ₅ D ₆ D ₇ D ₈ D ₉ D ₁₀ D ₁₁ D ₁₂ C/D Affix a modulus 10 C/D.
Other than 12 digits		Not to be drawn

(4) Auto affix of modulus 10 + Price C/D 4 digits

No. of Input Digits		
11 digits	Input Data	D ₁ D ₂ D ₃ D ₄ D ₅ D ₆ D ₇ D ₈ D ₉ D ₁₀ D ₁₁
	Drawing Data	D ₂ D ₃ D ₄ D ₅ D ₆ D ₇ P/CD D ₈ D ₉ D ₁₀ D ₁₁ C/D Affix price C/D 4 digits. Affix a modulus 10 C/D.
Other than 11 digits		Not to be drawn

(5) Auto affix of modulus 10 + Price C/D 5 digits

No. of Input Digits		
11 digits	Input Data	D ₁ D ₂ D ₃ D ₄ D ₅ D ₆ D ₇ D ₈ D ₉ D ₁₀ D ₁₁
	Drawing Data	D ₂ D ₃ D ₄ D ₅ D ₆ P/CD D ₇ D ₈ D ₉ D ₁₀ D ₁₁ C/D Affix price C/D 5 digits. Affix a modulus 10 C/D.
Other than 11 digits		Not to be drawn

Type of Bar Code: UPC-A

(1) No affix

No. of Input Digits														
12 digits	Input Data	<table border="1"> <tr> <td>D₁</td><td>D₂</td><td>D₃</td><td>D₄</td><td>D₅</td><td>D₆</td><td>D₇</td><td>D₈</td><td>D₉</td><td>D₁₀</td><td>D₁₁</td><td>D₁₂</td> </tr> </table> <p style="text-align: center;">To be checked as modulus 10 C/D</p>	D ₁	D ₂	D ₃	D ₄	D ₅	D ₆	D ₇	D ₈	D ₉	D ₁₀	D ₁₁	D ₁₂
	D ₁	D ₂	D ₃	D ₄	D ₅	D ₆	D ₇	D ₈	D ₉	D ₁₀	D ₁₁	D ₁₂		
Drawing Data	<table border="1"> <tr> <td>D₁</td><td>D₂</td><td>D₃</td><td>D₄</td><td>D₅</td><td>D₆</td><td>D₇</td><td>D₈</td><td>D₉</td><td>D₁₀</td><td>D₁₁</td><td>D₁₂</td> </tr> </table>	D ₁	D ₂	D ₃	D ₄	D ₅	D ₆	D ₇	D ₈	D ₉	D ₁₀	D ₁₁	D ₁₂	
D ₁	D ₂	D ₃	D ₄	D ₅	D ₆	D ₇	D ₈	D ₉	D ₁₀	D ₁₁	D ₁₂			
Other than 12 digits		Not to be drawn												

(2) Modulus 10 check

No. of Input Digits														
12 digits	Input Data	<table border="1"> <tr> <td>D₁</td><td>D₂</td><td>D₃</td><td>D₄</td><td>D₅</td><td>D₆</td><td>D₇</td><td>D₈</td><td>D₉</td><td>D₁₀</td><td>D₁₁</td><td>D₁₂</td> </tr> </table> <p style="text-align: center;">To be checked as modulus 10 C/D</p>	D ₁	D ₂	D ₃	D ₄	D ₅	D ₆	D ₇	D ₈	D ₉	D ₁₀	D ₁₁	D ₁₂
	D ₁	D ₂	D ₃	D ₄	D ₅	D ₆	D ₇	D ₈	D ₉	D ₁₀	D ₁₁	D ₁₂		
Drawing Data	<table border="1"> <tr> <td>D₁</td><td>D₂</td><td>D₃</td><td>D₄</td><td>D₅</td><td>D₆</td><td>D₇</td><td>D₈</td><td>D₉</td><td>D₁₀</td><td>D₁₁</td><td>D₁₂</td> </tr> </table>	D ₁	D ₂	D ₃	D ₄	D ₅	D ₆	D ₇	D ₈	D ₉	D ₁₀	D ₁₁	D ₁₂	
D ₁	D ₂	D ₃	D ₄	D ₅	D ₆	D ₇	D ₈	D ₉	D ₁₀	D ₁₁	D ₁₂			
Other than 12 digits		Not to be drawn												

(3) Auto affix of modulus 10

No. of Input Digits													
11 digits	Input Data	<table border="1"> <tr> <td>D₁</td><td>D₂</td><td>D₃</td><td>D₄</td><td>D₅</td><td>D₆</td><td>D₇</td><td>D₈</td><td>D₉</td><td>D₁₀</td><td>D₁₁</td> </tr> </table>	D ₁	D ₂	D ₃	D ₄	D ₅	D ₆	D ₇	D ₈	D ₉	D ₁₀	D ₁₁
	D ₁	D ₂	D ₃	D ₄	D ₅	D ₆	D ₇	D ₈	D ₉	D ₁₀	D ₁₁		
Drawing Data	<table border="1"> <tr> <td>D₁</td><td>D₂</td><td>D₃</td><td>D₄</td><td>D₅</td><td>D₆</td><td>D₇</td><td>D₈</td><td>D₉</td><td>D₁₀</td><td>D₁₁</td><td>C/D</td> </tr> </table> <p style="text-align: right;">Affix a modulus 10 C/D.</p>	D ₁	D ₂	D ₃	D ₄	D ₅	D ₆	D ₇	D ₈	D ₉	D ₁₀	D ₁₁	C/D
D ₁	D ₂	D ₃	D ₄	D ₅	D ₆	D ₇	D ₈	D ₉	D ₁₀	D ₁₁	C/D		
Other than 11 digits		Not to be drawn											

(4) Auto affix of modulus 10 + Price C/D 4 digits

No. of Input Digits													
10 digits	Input Data	<table border="1"> <tr> <td>D₁</td><td>D₂</td><td>D₃</td><td>D₄</td><td>D₅</td><td>D₆</td><td>D₇</td><td>D₈</td><td>D₉</td><td>D₁₀</td> </tr> </table>	D ₁	D ₂	D ₃	D ₄	D ₅	D ₆	D ₇	D ₈	D ₉	D ₁₀	
	D ₁	D ₂	D ₃	D ₄	D ₅	D ₆	D ₇	D ₈	D ₉	D ₁₀			
Drawing Data	<table border="1"> <tr> <td>D₁</td><td>D₂</td><td>D₃</td><td>D₄</td><td>D₅</td><td>D₆</td><td>P/CD</td><td>D₇</td><td>D₈</td><td>D₉</td><td>D₁₀</td><td>C/D</td> </tr> </table> <p style="text-align: right;">Affix price C/D 4 digits. Affix a modulus 10 C/D.</p>	D ₁	D ₂	D ₃	D ₄	D ₅	D ₆	P/CD	D ₇	D ₈	D ₉	D ₁₀	C/D
D ₁	D ₂	D ₃	D ₄	D ₅	D ₆	P/CD	D ₇	D ₈	D ₉	D ₁₀	C/D		
Other than 10 digits		Not to be drawn											

(5) Auto affix of modulus 10 + Price C/D 5 digits

No. of Input Digits													
10 digits	Input Data	<table border="1"> <tr> <td>D₁</td><td>D₂</td><td>D₃</td><td>D₄</td><td>D₅</td><td>D₆</td><td>D₇</td><td>D₈</td><td>D₉</td><td>D₁₀</td> </tr> </table>	D ₁	D ₂	D ₃	D ₄	D ₅	D ₆	D ₇	D ₈	D ₉	D ₁₀	
	D ₁	D ₂	D ₃	D ₄	D ₅	D ₆	D ₇	D ₈	D ₉	D ₁₀			
Drawing Data	<table border="1"> <tr> <td>D₁</td><td>D₂</td><td>D₃</td><td>D₄</td><td>D₅</td><td>P/CD</td><td>D₆</td><td>D₇</td><td>D₈</td><td>D₉</td><td>D₁₀</td><td>C/D</td> </tr> </table> <p style="text-align: right;">Affix price C/D 5 digits. Affix a modulus 10 C/D.</p>	D ₁	D ₂	D ₃	D ₄	D ₅	P/CD	D ₆	D ₇	D ₈	D ₉	D ₁₀	C/D
D ₁	D ₂	D ₃	D ₄	D ₅	P/CD	D ₆	D ₇	D ₈	D ₉	D ₁₀	C/D		
Other than 10 digits		Not to be drawn											

Type of Bar Code: UPC-E

(1) No affix

No. of Input Digits									
7 digits	Input Data	<table border="1" style="display: inline-table; vertical-align: middle;"> <tr> <td>D₁</td><td>D₂</td><td>D₃</td><td>D₄</td><td>D₅</td><td>D₆</td><td>D₇</td> </tr> </table> └─ To be checked as modulus 10 C/D	D ₁	D ₂	D ₃	D ₄	D ₅	D ₆	D ₇
	D ₁	D ₂	D ₃	D ₄	D ₅	D ₆	D ₇		
Drawing Data	<table border="1" style="display: inline-table; vertical-align: middle;"> <tr> <td>0</td><td>D₁</td><td>D₂</td><td>D₃</td><td>D₄</td><td>D₅</td><td>D₆</td><td>D₇</td> </tr> </table>	0	D ₁	D ₂	D ₃	D ₄	D ₅	D ₆	D ₇
0	D ₁	D ₂	D ₃	D ₄	D ₅	D ₆	D ₇		
Other than 7 digits		Not to be drawn							

(2) Modulus 10 check

No. of Input Digits									
7 digits	Input Data	<table border="1" style="display: inline-table; vertical-align: middle;"> <tr> <td>D₁</td><td>D₂</td><td>D₃</td><td>D₄</td><td>D₅</td><td>D₆</td><td>D₇</td> </tr> </table> └─ To be checked as modulus 10 C/D	D ₁	D ₂	D ₃	D ₄	D ₅	D ₆	D ₇
	D ₁	D ₂	D ₃	D ₄	D ₅	D ₆	D ₇		
Drawing Data	<table border="1" style="display: inline-table; vertical-align: middle;"> <tr> <td>0</td><td>D₁</td><td>D₂</td><td>D₃</td><td>D₄</td><td>D₅</td><td>D₆</td><td>D₇</td> </tr> </table>	0	D ₁	D ₂	D ₃	D ₄	D ₅	D ₆	D ₇
0	D ₁	D ₂	D ₃	D ₄	D ₅	D ₆	D ₇		
Other than 7 digits		Not to be drawn							

(3) Auto affix of modulus 10

No. of Input Digits									
6 digits	Input Data	<table border="1" style="display: inline-table; vertical-align: middle;"> <tr> <td>D₁</td><td>D₂</td><td>D₃</td><td>D₄</td><td>D₅</td><td>D₆</td> </tr> </table> Calculate and reflect modulus 10 in the bar code.	D ₁	D ₂	D ₃	D ₄	D ₅	D ₆	
	D ₁	D ₂	D ₃	D ₄	D ₅	D ₆			
Drawing Data	<table border="1" style="display: inline-table; vertical-align: middle;"> <tr> <td>0</td><td>D₁</td><td>D₂</td><td>D₃</td><td>D₄</td><td>D₅</td><td>D₆</td><td>C/D</td> </tr> </table>	0	D ₁	D ₂	D ₃	D ₄	D ₅	D ₆	C/D
0	D ₁	D ₂	D ₃	D ₄	D ₅	D ₆	C/D		
Other than 6 digits		Not to be drawn							

Type of Bar Code: JAN8 + 2 digits, EAN8 + 2 digits

(1) No affix

No. of Input Digits												
10 digits	Input Data	<table border="1"> <tr> <td>D₁</td><td>D₂</td><td>D₃</td><td>D₄</td><td>D₅</td><td>D₆</td><td>D₇</td><td>D₈</td><td>D₉</td><td>D₁₀</td> </tr> </table> <p style="text-align: right;">└─ To be checked as modulus 10 C/D</p>	D ₁	D ₂	D ₃	D ₄	D ₅	D ₆	D ₇	D ₈	D ₉	D ₁₀
	D ₁	D ₂	D ₃	D ₄	D ₅	D ₆	D ₇	D ₈	D ₉	D ₁₀		
Drawing Data	<table border="1"> <tr> <td>D₁</td><td>D₂</td><td>D₃</td><td>D₄</td><td>D₅</td><td>D₆</td><td>D₇</td><td>D₈</td> <td>D₉</td><td>D₁₀</td> </tr> </table>	D ₁	D ₂	D ₃	D ₄	D ₅	D ₆	D ₇	D ₈	D ₉	D ₁₀	
D ₁	D ₂	D ₃	D ₄	D ₅	D ₆	D ₇	D ₈	D ₉	D ₁₀			
Other than 10 digits		Not to be drawn										

(2) Modulus 10 check

No. of Input Digits												
10 digits	Input Data	<table border="1"> <tr> <td>D₁</td><td>D₂</td><td>D₃</td><td>D₄</td><td>D₅</td><td>D₆</td><td>D₇</td><td>D₈</td><td>D₉</td><td>D₁₀</td> </tr> </table> <p style="text-align: right;">└─ To be checked as modulus 10 C/D</p>	D ₁	D ₂	D ₃	D ₄	D ₅	D ₆	D ₇	D ₈	D ₉	D ₁₀
	D ₁	D ₂	D ₃	D ₄	D ₅	D ₆	D ₇	D ₈	D ₉	D ₁₀		
Drawing Data	<table border="1"> <tr> <td>D₁</td><td>D₂</td><td>D₃</td><td>D₄</td><td>D₅</td><td>D₆</td><td>D₇</td><td>D₈</td> <td>D₉</td><td>D₁₀</td> </tr> </table>	D ₁	D ₂	D ₃	D ₄	D ₅	D ₆	D ₇	D ₈	D ₉	D ₁₀	
D ₁	D ₂	D ₃	D ₄	D ₅	D ₆	D ₇	D ₈	D ₉	D ₁₀			
Other than 10 digits		Not to be drawn										

(3) Auto affix of modulus 10

No. of Input Digits											
9 digits	Input Data	<table border="1"> <tr> <td>D₁</td><td>D₂</td><td>D₃</td><td>D₄</td><td>D₅</td><td>D₆</td><td>D₇</td><td>D₈</td><td>D₉</td> </tr> </table>	D ₁	D ₂	D ₃	D ₄	D ₅	D ₆	D ₇	D ₈	D ₉
	D ₁	D ₂	D ₃	D ₄	D ₅	D ₆	D ₇	D ₈	D ₉		
Drawing Data	<table border="1"> <tr> <td>D₁</td><td>D₂</td><td>D₃</td><td>D₄</td><td>D₅</td><td>D₆</td><td>D₇</td><td>C/D</td> <td>D₈</td><td>D₉</td> </tr> </table> <p style="text-align: right;">└─ Affix a modulus 10 C/D.</p>	D ₁	D ₂	D ₃	D ₄	D ₅	D ₆	D ₇	C/D	D ₈	D ₉
D ₁	D ₂	D ₃	D ₄	D ₅	D ₆	D ₇	C/D	D ₈	D ₉		
Other than 9 digits		Not to be drawn									

Type of Bar Code: JAN8 + 5 digits, EAN8 + 5 digits

(1) No affix

No. of Input Digits															
13 digits	Input Data	<table border="1" style="display: inline-table; border-collapse: collapse;"> <tr> <td>D₁</td><td>D₂</td><td>D₃</td><td>D₄</td><td>D₅</td><td>D₆</td><td>D₇</td><td>D₈</td><td>D₉</td><td>D₁₀</td><td>D₁₁</td><td>D₁₂</td><td>D₁₃</td> </tr> </table> <div style="text-align: right; margin-right: 100px;">└─ To be checked as modulus 10 C/D</div>	D ₁	D ₂	D ₃	D ₄	D ₅	D ₆	D ₇	D ₈	D ₉	D ₁₀	D ₁₁	D ₁₂	D ₁₃
	D ₁	D ₂	D ₃	D ₄	D ₅	D ₆	D ₇	D ₈	D ₉	D ₁₀	D ₁₁	D ₁₂	D ₁₃		
Drawing Data	<table border="1" style="display: inline-table; border-collapse: collapse;"> <tr> <td>D₁</td><td>D₂</td><td>D₃</td><td>D₄</td><td>D₅</td><td>D₆</td><td>D₇</td><td>D₈</td> <td style="border: none;"> </td> <td>D₉</td><td>D₁₀</td><td>D₁₁</td><td>D₁₂</td><td>D₁₃</td> </tr> </table>	D ₁	D ₂	D ₃	D ₄	D ₅	D ₆	D ₇	D ₈		D ₉	D ₁₀	D ₁₁	D ₁₂	D ₁₃
D ₁	D ₂	D ₃	D ₄	D ₅	D ₆	D ₇	D ₈		D ₉	D ₁₀	D ₁₁	D ₁₂	D ₁₃		
Other than 13 digits		Not to be drawn													

(2) Modulus 10 check

No. of Input Digits															
13 digits	Input Data	<table border="1" style="display: inline-table; border-collapse: collapse;"> <tr> <td>D₁</td><td>D₂</td><td>D₃</td><td>D₄</td><td>D₅</td><td>D₆</td><td>D₇</td><td>D₈</td><td>D₉</td><td>D₁₀</td><td>D₁₁</td><td>D₁₂</td><td>D₁₃</td> </tr> </table> <div style="text-align: right; margin-right: 100px;">└─ To be checked as modulus 10 C/D</div>	D ₁	D ₂	D ₃	D ₄	D ₅	D ₆	D ₇	D ₈	D ₉	D ₁₀	D ₁₁	D ₁₂	D ₁₃
	D ₁	D ₂	D ₃	D ₄	D ₅	D ₆	D ₇	D ₈	D ₉	D ₁₀	D ₁₁	D ₁₂	D ₁₃		
Drawing Data	<table border="1" style="display: inline-table; border-collapse: collapse;"> <tr> <td>D₁</td><td>D₂</td><td>D₃</td><td>D₄</td><td>D₅</td><td>D₆</td><td>D₇</td><td>D₈</td> <td style="border: none;"> </td> <td>D₉</td><td>D₁₀</td><td>D₁₁</td><td>D₁₂</td><td>D₁₃</td> </tr> </table>	D ₁	D ₂	D ₃	D ₄	D ₅	D ₆	D ₇	D ₈		D ₉	D ₁₀	D ₁₁	D ₁₂	D ₁₃
D ₁	D ₂	D ₃	D ₄	D ₅	D ₆	D ₇	D ₈		D ₉	D ₁₀	D ₁₁	D ₁₂	D ₁₃		
Other than 13 digits		Not to be drawn													

(3) Auto affix of modulus 10

No. of Input Digits															
12 digits	Input Data	<table border="1" style="display: inline-table; border-collapse: collapse;"> <tr> <td>D₁</td><td>D₂</td><td>D₃</td><td>D₄</td><td>D₅</td><td>D₆</td><td>D₇</td><td>D₈</td><td>D₉</td><td>D₁₀</td><td>D₁₁</td><td>D₁₂</td> </tr> </table>	D ₁	D ₂	D ₃	D ₄	D ₅	D ₆	D ₇	D ₈	D ₉	D ₁₀	D ₁₁	D ₁₂	
	D ₁	D ₂	D ₃	D ₄	D ₅	D ₆	D ₇	D ₈	D ₉	D ₁₀	D ₁₁	D ₁₂			
Drawing Data	<table border="1" style="display: inline-table; border-collapse: collapse;"> <tr> <td>D₁</td><td>D₂</td><td>D₃</td><td>D₄</td><td>D₅</td><td>D₆</td><td>D₇</td><td>C/D</td> <td style="border: none;"> </td> <td>D₈</td><td>D₉</td><td>D₁₀</td><td>D₁₁</td><td>D₁₂</td> </tr> </table> <div style="text-align: right; margin-right: 100px;">└─ Affix a modulus 10 C/D.</div>	D ₁	D ₂	D ₃	D ₄	D ₅	D ₆	D ₇	C/D		D ₈	D ₉	D ₁₀	D ₁₁	D ₁₂
D ₁	D ₂	D ₃	D ₄	D ₅	D ₆	D ₇	C/D		D ₈	D ₉	D ₁₀	D ₁₁	D ₁₂		
Other than 12 digits		Not to be drawn													

Type of Bar Code: JAN13 + 2 digits, EAN13 + 2 digits

(1) No affix

No. of Input Digits		
15 digits	Input Data	D ₁ D ₂ D ₃ D ₄ D ₅ D ₆ D ₇ D ₈ D ₉ D ₁₀ D ₁₁ D ₁₂ D ₁₃ D ₁₄ D ₁₅
	Drawing Data	<div style="border: 1px solid black; padding: 2px; display: inline-block;"> D₂ D₃ D₄ D₅ D₆ D₇ D₈ D₉ D₁₀ D₁₁ D₁₂ D₁₃ </div> D₁₄ D₁₅
Other than 15 digits		Not to be drawn

(2) Modulus 10 check

No. of Input Digits		
15 digits	Input Data	D ₁ D ₂ D ₃ D ₄ D ₅ D ₆ D ₇ D ₈ D ₉ D ₁₀ D ₁₁ D ₁₂ D ₁₃ D ₁₄ D ₁₅
	Drawing Data	<div style="border: 1px solid black; padding: 2px; display: inline-block;"> D₂ D₃ D₄ D₅ D₆ D₇ D₈ D₉ D₁₀ D₁₁ D₁₂ D₁₃ </div> D₁₄ D₁₅
Other than 15 digits		Not to be drawn

(3) Auto affix of modulus 10

No. of Input Digits		
14 digits	Input Data	D ₁ D ₂ D ₃ D ₄ D ₅ D ₆ D ₇ D ₈ D ₉ D ₁₀ D ₁₁ D ₁₂ D ₁₃ D ₁₄
	Drawing Data	<div style="border: 1px solid black; padding: 2px; display: inline-block;"> D₂ D₃ D₄ D₅ D₆ D₇ D₈ D₉ D₁₀ D₁₁ D₁₂ C/D </div> D₁₃ D₁₄
Other than 14 digits		Not to be drawn

(4) Auto affix of modulus 10 + Price C/D 4 digits

No. of Input Digits		
13 digits	Input Data	D ₁ D ₂ D ₃ D ₄ D ₅ D ₆ D ₇ D ₈ D ₉ D ₁₀ D ₁₁ D ₁₂ D ₁₃
	Drawing Data	<div style="border: 1px solid black; padding: 2px; display: inline-block;"> D₂ D₃ D₄ D₅ D₆ D₇ P/CD D₈ D₉ D₁₀ D₁₁ C/D </div> D₁₂ D₁₃
Other than 13 digits		Not to be drawn

(5) Auto affix of modulus 10 + Price C/D 5 digits

No. of Input Digits		
13 digits	Input Data	D ₁ D ₂ D ₃ D ₄ D ₅ D ₆ D ₇ D ₈ D ₉ D ₁₀ D ₁₁ D ₁₂ D ₁₃
	Drawing Data	<div style="border: 1px solid black; padding: 2px; display: inline-block;"> D₂ D₃ D₄ D₅ D₆ P/CD D₇ D₈ D₉ D₁₀ D₁₁ C/D </div> D₁₂ D₁₃
Other than 13 digits		Not to be drawn

Type of Bar Code: JAN13 + 5 digits, EAN13 + 5 digits

(1) No affix

No. of Input Digits		
18 digits	Input Data	D ₁ D ₂ D ₃ D ₄ D ₅ D ₆ D ₇ D ₈ D ₉ D ₁₀ D ₁₁ D ₁₂ D ₁₃ D ₁₄ D ₁₅ D ₁₆ D ₁₇ D ₁₈
	Drawing Data	<div style="display: flex; justify-content: space-between;"> <div style="border: 1px solid black; padding: 2px;">D₂ D₃ D₄ D₅ D₆ D₇ D₈ D₉ D₁₀ D₁₁ D₁₂ D₁₃</div> <div style="border: 1px solid black; padding: 2px;">D₁₄ D₁₅ D₁₆ D₁₇ D₁₈</div> </div>
Other than 18 digits		Not to be drawn

(2) Modulus 10 check

No. of Input Digits		
18 digits	Input Data	D ₁ D ₂ D ₃ D ₄ D ₅ D ₆ D ₇ D ₈ D ₉ D ₁₀ D ₁₁ D ₁₂ D ₁₃ D ₁₄ D ₁₅ D ₁₆ D ₁₇ D ₁₈
	Drawing Data	<div style="display: flex; justify-content: space-between;"> <div style="border: 1px solid black; padding: 2px;">D₂ D₃ D₄ D₅ D₆ D₇ D₈ D₉ D₁₀ D₁₁ D₁₂ D₁₃</div> <div style="border: 1px solid black; padding: 2px;">D₁₄ D₁₅ D₁₆ D₁₇ D₁₈</div> </div>
Other than 18 digits		Not to be drawn

(3) Auto affix of modulus 10

No. of Input Digits		
17 digits	Input Data	D ₁ D ₂ D ₃ D ₄ D ₅ D ₆ D ₇ D ₈ D ₉ D ₁₀ D ₁₁ D ₁₂ D ₁₃ D ₁₄ D ₁₅ D ₁₆ D ₁₇
	Drawing Data	<div style="display: flex; justify-content: space-between;"> <div style="border: 1px solid black; padding: 2px;">D₂ D₃ D₄ D₅ D₆ D₇ D₈ D₉ D₁₀ D₁₁ D₁₂ C/D</div> <div style="border: 1px solid black; padding: 2px;">D₁₃ D₁₄ D₁₅ D₁₆ D₁₇</div> </div>
Other than 17 digits		Not to be drawn

(4) Auto affix of modulus 10 + Price C/D 4 digits

No. of Input Digits		
16 digits	Input Data	D ₁ D ₂ D ₃ D ₄ D ₅ D ₆ D ₇ D ₈ D ₉ D ₁₀ D ₁₁ D ₁₂ D ₁₃ D ₁₄ D ₁₅ D ₁₆
	Drawing Data	<div style="display: flex; justify-content: space-between;"> <div style="border: 1px solid black; padding: 2px;">D₂ D₃ D₄ D₅ D₆ D₇ P/CD D₈ D₉ D₁₀ D₁₁ C/D</div> <div style="border: 1px solid black; padding: 2px;">D₁₂ D₁₃ D₁₄ D₁₅ D₁₆</div> </div>
Other than 16 digits		Not to be drawn

(5) Auto affix of modulus 10 + Price C/D 5 digits

No. of Input Digits		
16 digits	Input Data	D ₁ D ₂ D ₃ D ₄ D ₅ D ₆ D ₇ D ₈ D ₉ D ₁₀ D ₁₁ D ₁₂ D ₁₃ D ₁₄ D ₁₅ D ₁₆
	Drawing Data	<div style="display: flex; justify-content: space-between;"> <div style="border: 1px solid black; padding: 2px;">D₂ D₃ D₄ D₅ D₆ P/CD D₇ D₈ D₉ D₁₀ D₁₁ C/D</div> <div style="border: 1px solid black; padding: 2px;">D₁₂ D₁₃ D₁₄ D₁₅ D₁₆</div> </div>
Other than 16 digits		Not to be drawn

Type of Bar Code: UPC-A + 2 digits

(1) No affix

No. of Input Digits																
14 digits	Input Data	<table border="1" style="display: inline-table; border-collapse: collapse;"> <tr> <td>D₁</td><td>D₂</td><td>D₃</td><td>D₄</td><td>D₅</td><td>D₆</td><td>D₇</td><td>D₈</td><td>D₉</td><td>D₁₀</td><td>D₁₁</td><td>D₁₂</td><td>D₁₃</td><td>D₁₄</td> </tr> </table> <p style="text-align: center;">To be checked as modulus 10 C/D</p>	D ₁	D ₂	D ₃	D ₄	D ₅	D ₆	D ₇	D ₈	D ₉	D ₁₀	D ₁₁	D ₁₂	D ₁₃	D ₁₄
	D ₁	D ₂	D ₃	D ₄	D ₅	D ₆	D ₇	D ₈	D ₉	D ₁₀	D ₁₁	D ₁₂	D ₁₃	D ₁₄		
Drawing Data	<table border="1" style="display: inline-table; border-collapse: collapse;"> <tr> <td>D₁</td><td>D₂</td><td>D₃</td><td>D₄</td><td>D₅</td><td>D₆</td><td>D₇</td><td>D₈</td><td>D₉</td><td>D₁₀</td><td>D₁₁</td><td>D₁₂</td> <td style="border: 1px solid black; padding: 2px;">D₁₃</td><td style="border: 1px solid black; padding: 2px;">D₁₄</td> </tr> </table>	D ₁	D ₂	D ₃	D ₄	D ₅	D ₆	D ₇	D ₈	D ₉	D ₁₀	D ₁₁	D ₁₂	D ₁₃	D ₁₄	
D ₁	D ₂	D ₃	D ₄	D ₅	D ₆	D ₇	D ₈	D ₉	D ₁₀	D ₁₁	D ₁₂	D ₁₃	D ₁₄			
Other than 14 digits		Not to be drawn														

(2) Modulus 10 check

No. of Input Digits																
14 digits	Input Data	<table border="1" style="display: inline-table; border-collapse: collapse;"> <tr> <td>D₁</td><td>D₂</td><td>D₃</td><td>D₄</td><td>D₅</td><td>D₆</td><td>D₇</td><td>D₈</td><td>D₉</td><td>D₁₀</td><td>D₁₁</td><td>D₁₂</td><td>D₁₃</td><td>D₁₄</td> </tr> </table> <p style="text-align: center;">To be checked as modulus 10 C/D</p>	D ₁	D ₂	D ₃	D ₄	D ₅	D ₆	D ₇	D ₈	D ₉	D ₁₀	D ₁₁	D ₁₂	D ₁₃	D ₁₄
	D ₁	D ₂	D ₃	D ₄	D ₅	D ₆	D ₇	D ₈	D ₉	D ₁₀	D ₁₁	D ₁₂	D ₁₃	D ₁₄		
Drawing Data	<table border="1" style="display: inline-table; border-collapse: collapse;"> <tr> <td>D₁</td><td>D₂</td><td>D₃</td><td>D₄</td><td>D₅</td><td>D₆</td><td>D₇</td><td>D₈</td><td>D₉</td><td>D₁₀</td><td>D₁₁</td><td>D₁₂</td> <td style="border: 1px solid black; padding: 2px;">D₁₃</td><td style="border: 1px solid black; padding: 2px;">D₁₄</td> </tr> </table>	D ₁	D ₂	D ₃	D ₄	D ₅	D ₆	D ₇	D ₈	D ₉	D ₁₀	D ₁₁	D ₁₂	D ₁₃	D ₁₄	
D ₁	D ₂	D ₃	D ₄	D ₅	D ₆	D ₇	D ₈	D ₉	D ₁₀	D ₁₁	D ₁₂	D ₁₃	D ₁₄			
Other than 14 digits		Not to be drawn														

(3) Auto affix of modulus 10

No. of Input Digits															
13 digits	Input Data	<table border="1" style="display: inline-table; border-collapse: collapse;"> <tr> <td>D₁</td><td>D₂</td><td>D₃</td><td>D₄</td><td>D₅</td><td>D₆</td><td>D₇</td><td>D₈</td><td>D₉</td><td>D₁₀</td><td>D₁₁</td><td>D₁₂</td><td>D₁₃</td> </tr> </table>	D ₁	D ₂	D ₃	D ₄	D ₅	D ₆	D ₇	D ₈	D ₉	D ₁₀	D ₁₁	D ₁₂	D ₁₃
	D ₁	D ₂	D ₃	D ₄	D ₅	D ₆	D ₇	D ₈	D ₉	D ₁₀	D ₁₁	D ₁₂	D ₁₃		
Drawing Data	<table border="1" style="display: inline-table; border-collapse: collapse;"> <tr> <td>D₁</td><td>D₂</td><td>D₃</td><td>D₄</td><td>D₅</td><td>D₆</td><td>D₇</td><td>D₈</td><td>D₉</td><td>D₁₀</td><td>D₁₁</td><td style="border: 1px solid black; padding: 2px;">C/D</td> <td style="border: 1px solid black; padding: 2px;">D₁₂</td><td style="border: 1px solid black; padding: 2px;">D₁₃</td> </tr> </table> <p style="text-align: right;">Affix a modulus 10 C/D.</p>	D ₁	D ₂	D ₃	D ₄	D ₅	D ₆	D ₇	D ₈	D ₉	D ₁₀	D ₁₁	C/D	D ₁₂	D ₁₃
D ₁	D ₂	D ₃	D ₄	D ₅	D ₆	D ₇	D ₈	D ₉	D ₁₀	D ₁₁	C/D	D ₁₂	D ₁₃		
Other than 13 digits		Not to be drawn													

(4) Auto affix of modulus 10 + Price C/D 4 digits

No. of Input Digits															
12 digits	Input Data	<table border="1" style="display: inline-table; border-collapse: collapse;"> <tr> <td>D₁</td><td>D₂</td><td>D₃</td><td>D₄</td><td>D₅</td><td>D₆</td><td>D₇</td><td>D₈</td><td>D₉</td><td>D₁₀</td><td>D₁₁</td><td>D₁₂</td> </tr> </table>	D ₁	D ₂	D ₃	D ₄	D ₅	D ₆	D ₇	D ₈	D ₉	D ₁₀	D ₁₁	D ₁₂	
	D ₁	D ₂	D ₃	D ₄	D ₅	D ₆	D ₇	D ₈	D ₉	D ₁₀	D ₁₁	D ₁₂			
Drawing Data	<table border="1" style="display: inline-table; border-collapse: collapse;"> <tr> <td>D₁</td><td>D₂</td><td>D₃</td><td>D₄</td><td>D₅</td><td>D₆</td><td style="border: 1px solid black; padding: 2px;">P/CD</td><td>D₇</td><td>D₈</td><td>D₉</td><td>D₁₀</td><td style="border: 1px solid black; padding: 2px;">C/D</td> <td style="border: 1px solid black; padding: 2px;">D₁₁</td><td style="border: 1px solid black; padding: 2px;">D₁₂</td> </tr> </table> <p style="text-align: right;">Affix price C/D 4 digits. Affix a modulus 10 C/D.</p>	D ₁	D ₂	D ₃	D ₄	D ₅	D ₆	P/CD	D ₇	D ₈	D ₉	D ₁₀	C/D	D ₁₁	D ₁₂
D ₁	D ₂	D ₃	D ₄	D ₅	D ₆	P/CD	D ₇	D ₈	D ₉	D ₁₀	C/D	D ₁₁	D ₁₂		
Other than 12 digits		Not to be drawn													

(5) Auto affix of modulus 10 + Price C/D 5 digits

No. of Input Digits															
12 digits	Input Data	<table border="1" style="display: inline-table; border-collapse: collapse;"> <tr> <td>D₁</td><td>D₂</td><td>D₃</td><td>D₄</td><td>D₅</td><td>D₆</td><td>D₇</td><td>D₈</td><td>D₉</td><td>D₁₀</td><td>D₁₁</td><td>D₁₂</td> </tr> </table>	D ₁	D ₂	D ₃	D ₄	D ₅	D ₆	D ₇	D ₈	D ₉	D ₁₀	D ₁₁	D ₁₂	
	D ₁	D ₂	D ₃	D ₄	D ₅	D ₆	D ₇	D ₈	D ₉	D ₁₀	D ₁₁	D ₁₂			
Drawing Data	<table border="1" style="display: inline-table; border-collapse: collapse;"> <tr> <td>D₁</td><td>D₂</td><td>D₃</td><td>D₄</td><td>D₅</td><td>D₆</td><td style="border: 1px solid black; padding: 2px;">P/CD</td><td>D₇</td><td>D₈</td><td>D₉</td><td>D₁₀</td><td style="border: 1px solid black; padding: 2px;">C/D</td> <td style="border: 1px solid black; padding: 2px;">D₁₁</td><td style="border: 1px solid black; padding: 2px;">D₁₂</td> </tr> </table> <p style="text-align: right;">Affix price C/D 5 digits. Affix a modulus 10 C/D.</p>	D ₁	D ₂	D ₃	D ₄	D ₅	D ₆	P/CD	D ₇	D ₈	D ₉	D ₁₀	C/D	D ₁₁	D ₁₂
D ₁	D ₂	D ₃	D ₄	D ₅	D ₆	P/CD	D ₇	D ₈	D ₉	D ₁₀	C/D	D ₁₁	D ₁₂		
Other than 12 digits		Not to be drawn													

Type of Bar Code: UPC-A + 5 digits

(1) No affix

No. of Input Digits																			
17 digits	Input Data	<table border="1" style="display: inline-table; border-collapse: collapse;"> <tr> <td>D₁</td><td>D₂</td><td>D₃</td><td>D₄</td><td>D₅</td><td>D₆</td><td>D₇</td><td>D₈</td><td>D₉</td><td>D₁₀</td><td>D₁₁</td><td>D₁₂</td><td>D₁₃</td><td>D₁₄</td><td>D₁₅</td><td>D₁₆</td><td>D₁₇</td> </tr> </table> <p style="text-align: center;">To be checked as modulus 10 C/D</p>	D ₁	D ₂	D ₃	D ₄	D ₅	D ₆	D ₇	D ₈	D ₉	D ₁₀	D ₁₁	D ₁₂	D ₁₃	D ₁₄	D ₁₅	D ₁₆	D ₁₇
	D ₁	D ₂	D ₃	D ₄	D ₅	D ₆	D ₇	D ₈	D ₉	D ₁₀	D ₁₁	D ₁₂	D ₁₃	D ₁₄	D ₁₅	D ₁₆	D ₁₇		
Drawing Data	<table border="1" style="display: inline-table; border-collapse: collapse;"> <tr> <td>D₁</td><td>D₂</td><td>D₃</td><td>D₄</td><td>D₅</td><td>D₆</td><td>D₇</td><td>D₈</td><td>D₉</td><td>D₁₀</td><td>D₁₁</td><td>D₁₂</td> <td style="margin-left: 20px;">D₁₃</td><td>D₁₄</td><td>D₁₅</td><td>D₁₆</td><td>D₁₇</td> </tr> </table>	D ₁	D ₂	D ₃	D ₄	D ₅	D ₆	D ₇	D ₈	D ₉	D ₁₀	D ₁₁	D ₁₂	D ₁₃	D ₁₄	D ₁₅	D ₁₆	D ₁₇	
D ₁	D ₂	D ₃	D ₄	D ₅	D ₆	D ₇	D ₈	D ₉	D ₁₀	D ₁₁	D ₁₂	D ₁₃	D ₁₄	D ₁₅	D ₁₆	D ₁₇			
Other than 17 digits		Not to be drawn																	

(2) Modulus 10 check

No. of Input Digits																			
17 digits	Input Data	<table border="1" style="display: inline-table; border-collapse: collapse;"> <tr> <td>D₁</td><td>D₂</td><td>D₃</td><td>D₄</td><td>D₅</td><td>D₆</td><td>D₇</td><td>D₈</td><td>D₉</td><td>D₁₀</td><td>D₁₁</td><td>D₁₂</td><td>D₁₃</td><td>D₁₄</td><td>D₁₅</td><td>D₁₆</td><td>D₁₇</td> </tr> </table> <p style="text-align: center;">To be checked as modulus 10 C/D</p>	D ₁	D ₂	D ₃	D ₄	D ₅	D ₆	D ₇	D ₈	D ₉	D ₁₀	D ₁₁	D ₁₂	D ₁₃	D ₁₄	D ₁₅	D ₁₆	D ₁₇
	D ₁	D ₂	D ₃	D ₄	D ₅	D ₆	D ₇	D ₈	D ₉	D ₁₀	D ₁₁	D ₁₂	D ₁₃	D ₁₄	D ₁₅	D ₁₆	D ₁₇		
Drawing Data	<table border="1" style="display: inline-table; border-collapse: collapse;"> <tr> <td>D₁</td><td>D₂</td><td>D₃</td><td>D₄</td><td>D₅</td><td>D₆</td><td>D₇</td><td>D₈</td><td>D₉</td><td>D₁₀</td><td>D₁₁</td><td>D₁₂</td> <td style="margin-left: 20px;">D₁₃</td><td>D₁₄</td><td>D₁₅</td><td>D₁₆</td><td>D₁₇</td> </tr> </table>	D ₁	D ₂	D ₃	D ₄	D ₅	D ₆	D ₇	D ₈	D ₉	D ₁₀	D ₁₁	D ₁₂	D ₁₃	D ₁₄	D ₁₅	D ₁₆	D ₁₇	
D ₁	D ₂	D ₃	D ₄	D ₅	D ₆	D ₇	D ₈	D ₉	D ₁₀	D ₁₁	D ₁₂	D ₁₃	D ₁₄	D ₁₅	D ₁₆	D ₁₇			
Other than 17 digits		Not to be drawn																	

(3) Auto affix of modulus 10

No. of Input Digits																		
16 digits	Input Data	<table border="1" style="display: inline-table; border-collapse: collapse;"> <tr> <td>D₁</td><td>D₂</td><td>D₃</td><td>D₄</td><td>D₅</td><td>D₆</td><td>D₇</td><td>D₈</td><td>D₉</td><td>D₁₀</td><td>D₁₁</td><td>D₁₂</td><td>D₁₃</td><td>D₁₄</td><td>D₁₅</td><td>D₁₆</td> </tr> </table>	D ₁	D ₂	D ₃	D ₄	D ₅	D ₆	D ₇	D ₈	D ₉	D ₁₀	D ₁₁	D ₁₂	D ₁₃	D ₁₄	D ₁₅	D ₁₆
	D ₁	D ₂	D ₃	D ₄	D ₅	D ₆	D ₇	D ₈	D ₉	D ₁₀	D ₁₁	D ₁₂	D ₁₃	D ₁₄	D ₁₅	D ₁₆		
Drawing Data	<table border="1" style="display: inline-table; border-collapse: collapse;"> <tr> <td>D₁</td><td>D₂</td><td>D₃</td><td>D₄</td><td>D₅</td><td>D₆</td><td>D₇</td><td>D₈</td><td>D₉</td><td>D₁₀</td><td>D₁₁</td><td>C/D</td> <td style="margin-left: 20px;">D₁₂</td><td>D₁₃</td><td>D₁₄</td><td>D₁₅</td><td>D₁₆</td> </tr> </table> <p style="text-align: right;">Affix a modulus 10 C/D.</p>	D ₁	D ₂	D ₃	D ₄	D ₅	D ₆	D ₇	D ₈	D ₉	D ₁₀	D ₁₁	C/D	D ₁₂	D ₁₃	D ₁₄	D ₁₅	D ₁₆
D ₁	D ₂	D ₃	D ₄	D ₅	D ₆	D ₇	D ₈	D ₉	D ₁₀	D ₁₁	C/D	D ₁₂	D ₁₃	D ₁₄	D ₁₅	D ₁₆		
Other than 16 digits		Not to be drawn																

(4) Auto affix of modulus 10 + Price C/D 4 digits

No. of Input Digits																		
15 digits	Input Data	<table border="1" style="display: inline-table; border-collapse: collapse;"> <tr> <td>D₁</td><td>D₂</td><td>D₃</td><td>D₄</td><td>D₅</td><td>D₆</td><td>D₇</td><td>D₈</td><td>D₉</td><td>D₁₀</td><td>D₁₁</td><td>D₁₂</td><td>D₁₃</td><td>D₁₄</td><td>D₁₅</td> </tr> </table>	D ₁	D ₂	D ₃	D ₄	D ₅	D ₆	D ₇	D ₈	D ₉	D ₁₀	D ₁₁	D ₁₂	D ₁₃	D ₁₄	D ₁₅	
	D ₁	D ₂	D ₃	D ₄	D ₅	D ₆	D ₇	D ₈	D ₉	D ₁₀	D ₁₁	D ₁₂	D ₁₃	D ₁₄	D ₁₅			
Drawing Data	<table border="1" style="display: inline-table; border-collapse: collapse;"> <tr> <td>D₁</td><td>D₂</td><td>D₃</td><td>D₄</td><td>D₅</td><td>D₆</td><td>P/CD</td><td>D₇</td><td>D₈</td><td>D₉</td><td>D₁₀</td><td>C/D</td> <td style="margin-left: 20px;">D₁₁</td><td>D₁₂</td><td>D₁₃</td><td>D₁₄</td><td>D₁₅</td> </tr> </table> <p style="text-align: right;">Affix price C/D 4 digits. Affix a modulus 10 C/D.</p>	D ₁	D ₂	D ₃	D ₄	D ₅	D ₆	P/CD	D ₇	D ₈	D ₉	D ₁₀	C/D	D ₁₁	D ₁₂	D ₁₃	D ₁₄	D ₁₅
D ₁	D ₂	D ₃	D ₄	D ₅	D ₆	P/CD	D ₇	D ₈	D ₉	D ₁₀	C/D	D ₁₁	D ₁₂	D ₁₃	D ₁₄	D ₁₅		
Other than 15 digits		Not to be drawn																

(5) Auto affix of modulus 10 + Price C/D 5 digits

No. of Input Digits																		
15 digits	Input Data	<table border="1" style="display: inline-table; border-collapse: collapse;"> <tr> <td>D₁</td><td>D₂</td><td>D₃</td><td>D₄</td><td>D₅</td><td>D₆</td><td>D₇</td><td>D₈</td><td>D₉</td><td>D₁₀</td><td>D₁₁</td><td>D₁₂</td><td>D₁₃</td><td>D₁₄</td><td>D₁₅</td> </tr> </table>	D ₁	D ₂	D ₃	D ₄	D ₅	D ₆	D ₇	D ₈	D ₉	D ₁₀	D ₁₁	D ₁₂	D ₁₃	D ₁₄	D ₁₅	
	D ₁	D ₂	D ₃	D ₄	D ₅	D ₆	D ₇	D ₈	D ₉	D ₁₀	D ₁₁	D ₁₂	D ₁₃	D ₁₄	D ₁₅			
Drawing Data	<table border="1" style="display: inline-table; border-collapse: collapse;"> <tr> <td>D₁</td><td>D₂</td><td>D₃</td><td>D₄</td><td>D₅</td><td>P/CD</td><td>D₆</td><td>D₇</td><td>D₈</td><td>D₉</td><td>D₁₀</td><td>C/D</td> <td style="margin-left: 20px;">D₁₁</td><td>D₁₂</td><td>D₁₃</td><td>D₁₄</td><td>D₁₅</td> </tr> </table> <p style="text-align: right;">Affix price C/D 5 digits. Affix a modulus 10 C/D.</p>	D ₁	D ₂	D ₃	D ₄	D ₅	P/CD	D ₆	D ₇	D ₈	D ₉	D ₁₀	C/D	D ₁₁	D ₁₂	D ₁₃	D ₁₄	D ₁₅
D ₁	D ₂	D ₃	D ₄	D ₅	P/CD	D ₆	D ₇	D ₈	D ₉	D ₁₀	C/D	D ₁₁	D ₁₂	D ₁₃	D ₁₄	D ₁₅		
Other than 15 digits		Not to be drawn																

Type of Bar Code: UPC-E + 2 digits

(1) No affix

No. of Input Digits											
9 digits	Input Data	<table border="1" style="display: inline-table; vertical-align: middle;"> <tr> <td>D₁</td><td>D₂</td><td>D₃</td><td>D₄</td><td>D₅</td><td>D₆</td><td>D₇</td><td>D₈</td><td>D₉</td> </tr> </table> <div style="margin-left: 150px;">└─ To be checked as modulus 10 C/D</div>	D ₁	D ₂	D ₃	D ₄	D ₅	D ₆	D ₇	D ₈	D ₉
	D ₁	D ₂	D ₃	D ₄	D ₅	D ₆	D ₇	D ₈	D ₉		
Drawing Data	<table border="1" style="display: inline-table; vertical-align: middle;"> <tr> <td>0</td><td>D₁</td><td>D₂</td><td>D₃</td><td>D₄</td><td>D₅</td><td>D₆</td><td>D₇</td><td>D₈</td><td>D₉</td> </tr> </table>	0	D ₁	D ₂	D ₃	D ₄	D ₅	D ₆	D ₇	D ₈	D ₉
0	D ₁	D ₂	D ₃	D ₄	D ₅	D ₆	D ₇	D ₈	D ₉		
Other than 9 digits		Not to be drawn									

(2) Modulus 10 check

No. of Input Digits											
9 digits	Input Data	<table border="1" style="display: inline-table; vertical-align: middle;"> <tr> <td>D₁</td><td>D₂</td><td>D₃</td><td>D₄</td><td>D₅</td><td>D₆</td><td>D₇</td><td>D₈</td><td>D₉</td> </tr> </table> <div style="margin-left: 150px;">└─ To be checked as modulus 10 C/D</div>	D ₁	D ₂	D ₃	D ₄	D ₅	D ₆	D ₇	D ₈	D ₉
	D ₁	D ₂	D ₃	D ₄	D ₅	D ₆	D ₇	D ₈	D ₉		
Drawing Data	<table border="1" style="display: inline-table; vertical-align: middle;"> <tr> <td>0</td><td>D₁</td><td>D₂</td><td>D₃</td><td>D₄</td><td>D₅</td><td>D₆</td><td>D₇</td><td>D₈</td><td>D₉</td> </tr> </table>	0	D ₁	D ₂	D ₃	D ₄	D ₅	D ₆	D ₇	D ₈	D ₉
0	D ₁	D ₂	D ₃	D ₄	D ₅	D ₆	D ₇	D ₈	D ₉		
Other than 9 digits		Not to be drawn									

(3) Auto affix of modulus 10

No. of Input Digits											
8 digits	Input Data	<table border="1" style="display: inline-table; vertical-align: middle;"> <tr> <td>D₁</td><td>D₂</td><td>D₃</td><td>D₄</td><td>D₅</td><td>D₆</td><td>D₇</td><td>D₈</td> </tr> </table> <div style="margin-left: 100px;">Calculate and reflect modulus 10 C/D in the bar code.</div>	D ₁	D ₂	D ₃	D ₄	D ₅	D ₆	D ₇	D ₈	
	D ₁	D ₂	D ₃	D ₄	D ₅	D ₆	D ₇	D ₈			
Drawing Data	<table border="1" style="display: inline-table; vertical-align: middle;"> <tr> <td>0</td><td>D₁</td><td>D₂</td><td>D₃</td><td>D₄</td><td>D₅</td><td>D₆</td><td>C/D</td><td>D₇</td><td>D₈</td> </tr> </table>	0	D ₁	D ₂	D ₃	D ₄	D ₅	D ₆	C/D	D ₇	D ₈
0	D ₁	D ₂	D ₃	D ₄	D ₅	D ₆	C/D	D ₇	D ₈		
Other than 8 digits		Not to be drawn									

Type of Bar Code: UPC-E + 5 digits

(1) No affix

No. of Input Digits														
12 digits	Input Data	<table border="1" style="display: inline-table; border-collapse: collapse;"> <tr> <td>D₁</td><td>D₂</td><td>D₃</td><td>D₄</td><td>D₅</td><td>D₆</td><td>D₇</td><td>D₈</td><td>D₉</td><td>D₁₀</td><td>D₁₁</td><td>D₁₂</td> </tr> </table> <div style="margin-left: 100px;">└─ To be checked as modulus 10 C/D</div>	D ₁	D ₂	D ₃	D ₄	D ₅	D ₆	D ₇	D ₈	D ₉	D ₁₀	D ₁₁	D ₁₂
	D ₁	D ₂	D ₃	D ₄	D ₅	D ₆	D ₇	D ₈	D ₉	D ₁₀	D ₁₁	D ₁₂		
Drawing Data	<table border="1" style="display: inline-table; border-collapse: collapse;"> <tr> <td>0</td><td>D₁</td><td>D₂</td><td>D₃</td><td>D₄</td><td>D₅</td><td>D₆</td><td>D₇</td><td>D₈</td><td>D₉</td><td>D₁₀</td><td>D₁₁</td><td>D₁₂</td> </tr> </table>	0	D ₁	D ₂	D ₃	D ₄	D ₅	D ₆	D ₇	D ₈	D ₉	D ₁₀	D ₁₁	D ₁₂
0	D ₁	D ₂	D ₃	D ₄	D ₅	D ₆	D ₇	D ₈	D ₉	D ₁₀	D ₁₁	D ₁₂		
Other than 12 digits		Not to be drawn												

(2) Modulus 10 check

No. of Input Digits														
12 digits	Input Data	<table border="1" style="display: inline-table; border-collapse: collapse;"> <tr> <td>D₁</td><td>D₂</td><td>D₃</td><td>D₄</td><td>D₅</td><td>D₆</td><td>D₇</td><td>D₈</td><td>D₉</td><td>D₁₀</td><td>D₁₁</td><td>D₁₂</td> </tr> </table> <div style="margin-left: 100px;">└─ To be checked as modulus 10 C/D</div>	D ₁	D ₂	D ₃	D ₄	D ₅	D ₆	D ₇	D ₈	D ₉	D ₁₀	D ₁₁	D ₁₂
	D ₁	D ₂	D ₃	D ₄	D ₅	D ₆	D ₇	D ₈	D ₉	D ₁₀	D ₁₁	D ₁₂		
Drawing Data	<table border="1" style="display: inline-table; border-collapse: collapse;"> <tr> <td>0</td><td>D₁</td><td>D₂</td><td>D₃</td><td>D₄</td><td>D₅</td><td>D₆</td><td>D₇</td><td>D₈</td><td>D₉</td><td>D₁₀</td><td>D₁₁</td><td>D₁₂</td> </tr> </table>	0	D ₁	D ₂	D ₃	D ₄	D ₅	D ₆	D ₇	D ₈	D ₉	D ₁₀	D ₁₁	D ₁₂
0	D ₁	D ₂	D ₃	D ₄	D ₅	D ₆	D ₇	D ₈	D ₉	D ₁₀	D ₁₁	D ₁₂		
Other than 12 digits		Not to be drawn												

(3) Auto affix of modulus 10

No. of Input Digits														
11 digits	Input Data	<table border="1" style="display: inline-table; border-collapse: collapse;"> <tr> <td>D₁</td><td>D₂</td><td>D₃</td><td>D₄</td><td>D₅</td><td>D₆</td><td>D₇</td><td>D₈</td><td>D₉</td><td>D₁₀</td><td>D₁₁</td> </tr> </table> <div style="margin-left: 100px;">Calculate and reflect modulus 10 C/D in the bar code.</div>	D ₁	D ₂	D ₃	D ₄	D ₅	D ₆	D ₇	D ₈	D ₉	D ₁₀	D ₁₁	
	D ₁	D ₂	D ₃	D ₄	D ₅	D ₆	D ₇	D ₈	D ₉	D ₁₀	D ₁₁			
Drawing Data	<table border="1" style="display: inline-table; border-collapse: collapse;"> <tr> <td>0</td><td>D₁</td><td>D₂</td><td>D₃</td><td>D₄</td><td>D₅</td><td>D₆</td><td>C/D</td><td>D₇</td><td>D₈</td><td>D₉</td><td>D₁₀</td><td>D₁₁</td> </tr> </table>	0	D ₁	D ₂	D ₃	D ₄	D ₅	D ₆	C/D	D ₇	D ₈	D ₉	D ₁₀	D ₁₁
0	D ₁	D ₂	D ₃	D ₄	D ₅	D ₆	C/D	D ₇	D ₈	D ₉	D ₁₀	D ₁₁		
Other than 11 digits		Not to be drawn												

Type of Bar Code: MSI

(1) No affix

No. of Input Digits											
Max. 15 digits	Input Data	<table border="1"> <tr> <td>D₁</td><td>D₂</td><td>D₃</td><td>D₄</td><td>D₅</td><td>D₆</td><td>D₇</td><td>D₈</td><td>D₉</td> </tr> </table> <p style="text-align: right;">Not recognized as a check digit.</p>	D ₁	D ₂	D ₃	D ₄	D ₅	D ₆	D ₇	D ₈	D ₉
	D ₁	D ₂	D ₃	D ₄	D ₅	D ₆	D ₇	D ₈	D ₉		
Drawing Data	<table border="1"> <tr> <td>D₁</td><td>D₂</td><td>D₃</td><td>D₄</td><td>D₅</td><td>D₆</td><td>D₇</td><td>D₈</td><td>D₉</td> </tr> </table>	D ₁	D ₂	D ₃	D ₄	D ₅	D ₆	D ₇	D ₈	D ₉	
D ₁	D ₂	D ₃	D ₄	D ₅	D ₆	D ₇	D ₈	D ₉			
16 digits or more		Not to be drawn									

(2) IBM modulus 10 check

No. of Input Digits												
Min. 2 digits Max. 15 digits (including C/D)	Input Data	<table border="1"> <tr> <td>D₁</td><td>D₂</td><td>D₃</td><td>D₄</td><td>D₅</td><td>D₆</td><td>D₇</td><td>D₈</td><td>D₉</td><td>D₁₀</td> </tr> </table> <p style="text-align: right;">To be checked as IBM modulus 10</p>	D ₁	D ₂	D ₃	D ₄	D ₅	D ₆	D ₇	D ₈	D ₉	D ₁₀
	D ₁	D ₂	D ₃	D ₄	D ₅	D ₆	D ₇	D ₈	D ₉	D ₁₀		
Drawing Data	<table border="1"> <tr> <td>D₁</td><td>D₂</td><td>D₃</td><td>D₄</td><td>D₅</td><td>D₆</td><td>D₇</td><td>D₈</td><td>D₉</td><td>D₁₀</td> </tr> </table>	D ₁	D ₂	D ₃	D ₄	D ₅	D ₆	D ₇	D ₈	D ₉	D ₁₀	
D ₁	D ₂	D ₃	D ₄	D ₅	D ₆	D ₇	D ₈	D ₉	D ₁₀			
1 digit 16 digits or more		Not to be drawn										

(3) Auto affix of IBM modulus 10

No. of Input Digits											
Max. 14 digits	Input Data	<table border="1"> <tr> <td>D₁</td><td>D₂</td><td>D₃</td><td>D₄</td><td>D₅</td><td>D₆</td><td>D₇</td><td>D₈</td><td>D₉</td> </tr> </table>	D ₁	D ₂	D ₃	D ₄	D ₅	D ₆	D ₇	D ₈	D ₉
	D ₁	D ₂	D ₃	D ₄	D ₅	D ₆	D ₇	D ₈	D ₉		
Drawing Data	<table border="1"> <tr> <td>D₁</td><td>D₂</td><td>D₃</td><td>D₄</td><td>D₅</td><td>D₆</td><td>D₇</td><td>D₆</td><td>D₉</td><td>C/D</td> </tr> </table> <p style="text-align: right;">Affix IBM modulus 10.</p>	D ₁	D ₂	D ₃	D ₄	D ₅	D ₆	D ₇	D ₆	D ₉	C/D
D ₁	D ₂	D ₃	D ₄	D ₅	D ₆	D ₇	D ₆	D ₉	C/D		
15 digits or more		Not to be drawn									

(4) IBM modulus 10 + Auto affix of IBM modulus 10

No. of Input Digits												
Max. 13 digits	Input Data	<table border="1"> <tr> <td>D₁</td><td>D₂</td><td>D₃</td><td>D₄</td><td>D₅</td><td>D₆</td><td>D₇</td><td>D₈</td><td>D₉</td> </tr> </table>	D ₁	D ₂	D ₃	D ₄	D ₅	D ₆	D ₇	D ₈	D ₉	
	D ₁	D ₂	D ₃	D ₄	D ₅	D ₆	D ₇	D ₈	D ₉			
Drawing Data	<table border="1"> <tr> <td>D₁</td><td>D₂</td><td>D₃</td><td>D₄</td><td>D₅</td><td>D₆</td><td>D₇</td><td>D₆</td><td>D₉</td><td>C/D₁</td><td>C/D₂</td> </tr> </table> <p style="text-align: right;">Affix IBM modulus 10. Affix IBM modulus 10.</p>	D ₁	D ₂	D ₃	D ₄	D ₅	D ₆	D ₇	D ₆	D ₉	C/D ₁	C/D ₂
D ₁	D ₂	D ₃	D ₄	D ₅	D ₆	D ₇	D ₆	D ₉	C/D ₁	C/D ₂		
14 digits or more		Not to be drawn										

(5) IBM modulus 11 + Auto affix of IBM modulus 10

No. of Input Digits												
Max. 13 digits	Input Data	<table border="1"> <tr> <td>D₁</td><td>D₂</td><td>D₃</td><td>D₄</td><td>D₅</td><td>D₆</td><td>D₇</td><td>D₈</td><td>D₉</td> </tr> </table>	D ₁	D ₂	D ₃	D ₄	D ₅	D ₆	D ₇	D ₈	D ₉	
	D ₁	D ₂	D ₃	D ₄	D ₅	D ₆	D ₇	D ₈	D ₉			
Drawing Data	<table border="1"> <tr> <td>D₁</td><td>D₂</td><td>D₃</td><td>D₄</td><td>D₅</td><td>D₆</td><td>D₇</td><td>D₆</td><td>D₉</td><td>C/D₁</td><td>C/D₂</td> </tr> </table> <p style="text-align: right;">Affix IBM modulus 10. Affix IBM modulus 11.</p>	D ₁	D ₂	D ₃	D ₄	D ₅	D ₆	D ₇	D ₆	D ₉	C/D ₁	C/D ₂
D ₁	D ₂	D ₃	D ₄	D ₅	D ₆	D ₇	D ₆	D ₉	C/D ₁	C/D ₂		
14 digits or more		Not to be drawn										

Type of Bar Code: Interleaved 2 of 5

(1) No affix

No. of Input Digits												
Max. 126 digits	Input Data	<table border="1" style="display: inline-table; border-collapse: collapse;"> <tr> <td>D₁</td><td>D₂</td><td>D₃</td><td>D₄</td><td>D₅</td><td>D₆</td><td>D₇</td><td>D₈</td><td>D₉</td> </tr> </table>	D ₁	D ₂	D ₃	D ₄	D ₅	D ₆	D ₇	D ₈	D ₉	
	D ₁	D ₂	D ₃	D ₄	D ₅	D ₆	D ₇	D ₈	D ₉			
Drawing Data	<table border="1" style="display: inline-table; border-collapse: collapse;"> <tr> <td style="border: none;">0</td> <td style="border: none;"> </td> <td>D₁</td><td>D₂</td><td>D₃</td><td>D₄</td><td>D₅</td><td>D₆</td><td>D₇</td><td>D₈</td><td>D₉</td> </tr> </table>	0		D ₁	D ₂	D ₃	D ₄	D ₅	D ₆	D ₇	D ₈	D ₉
0		D ₁	D ₂	D ₃	D ₄	D ₅	D ₆	D ₇	D ₈	D ₉		
127 digits or more		Not to be drawn										

Not recognized as a check digit.

(2) Modulus 10 check

No. of Input Digits												
Min. 2 digits Max. 126 digits (including C/D)	Input Data	<table border="1" style="display: inline-table; border-collapse: collapse;"> <tr> <td>D₁</td><td>D₂</td><td>D₃</td><td>D₄</td><td>D₅</td><td>D₆</td><td>D₇</td><td>D₈</td><td>D₉</td> </tr> </table>	D ₁	D ₂	D ₃	D ₄	D ₅	D ₆	D ₇	D ₈	D ₉	
	D ₁	D ₂	D ₃	D ₄	D ₅	D ₆	D ₇	D ₈	D ₉			
Drawing Data	<table border="1" style="display: inline-table; border-collapse: collapse;"> <tr> <td style="border: none;">0</td> <td style="border: none;"> </td> <td>D₁</td><td>D₂</td><td>D₃</td><td>D₄</td><td>D₅</td><td>D₆</td><td>D₇</td><td>D₈</td><td>D₉</td> </tr> </table>	0		D ₁	D ₂	D ₃	D ₄	D ₅	D ₆	D ₇	D ₈	D ₉
0		D ₁	D ₂	D ₃	D ₄	D ₅	D ₆	D ₇	D ₈	D ₉		
1 digit 127 digits or more		Not to be drawn										

To be checked as modulus 10 C/D

(3) Auto affix of modulus 10

No. of Input Digits												
Max. 125 digits	Input Data	<table border="1" style="display: inline-table; border-collapse: collapse;"> <tr> <td>D₁</td><td>D₂</td><td>D₃</td><td>D₄</td><td>D₅</td><td>D₆</td><td>D₇</td><td>D₈</td><td>D₉</td> </tr> </table>	D ₁	D ₂	D ₃	D ₄	D ₅	D ₆	D ₇	D ₈	D ₉	
	D ₁	D ₂	D ₃	D ₄	D ₅	D ₆	D ₇	D ₈	D ₉			
Drawing Data	<table border="1" style="display: inline-table; border-collapse: collapse;"> <tr> <td style="border: none;"> </td> <td>D₁</td><td>D₂</td><td>D₃</td><td>D₄</td><td>D₅</td><td>D₆</td><td>D₇</td><td>D₈</td><td>D₉</td><td>C/D</td> </tr> </table>		D ₁	D ₂	D ₃	D ₄	D ₅	D ₆	D ₇	D ₈	D ₉	C/D
	D ₁	D ₂	D ₃	D ₄	D ₅	D ₆	D ₇	D ₈	D ₉	C/D		
126 digits or more		Not to be drawn										

Affix a modulus 10 C/D.

(4) Auto affix of DBP modulus 10

No. of Input Digits												
Max. 125 digits	Input Data	<table border="1" style="display: inline-table; border-collapse: collapse;"> <tr> <td>D₁</td><td>D₂</td><td>D₃</td><td>D₄</td><td>D₅</td><td>D₆</td><td>D₇</td><td>D₈</td><td>D₉</td> </tr> </table>	D ₁	D ₂	D ₃	D ₄	D ₅	D ₆	D ₇	D ₈	D ₉	
	D ₁	D ₂	D ₃	D ₄	D ₅	D ₆	D ₇	D ₈	D ₉			
Drawing Data	<table border="1" style="display: inline-table; border-collapse: collapse;"> <tr> <td style="border: none;"> </td> <td>D₁</td><td>D₂</td><td>D₃</td><td>D₄</td><td>D₅</td><td>D₆</td><td>D₇</td><td>D₈</td><td>D₉</td><td>C/D</td> </tr> </table>		D ₁	D ₂	D ₃	D ₄	D ₅	D ₆	D ₇	D ₈	D ₉	C/D
	D ₁	D ₂	D ₃	D ₄	D ₅	D ₆	D ₇	D ₈	D ₉	C/D		
126 digits or more		Not to be drawn										

Affix a DBP modulus 10 C/D.

Type of Bar Code: Industrial 2 of 5

(1) No affix

No. of Input Digits											
Max. 126 digits	Input Data	<table border="1"> <tr> <td>D₁</td><td>D₂</td><td>D₃</td><td>D₄</td><td>D₅</td><td>D₆</td><td>D₇</td><td>D₈</td><td>D₉</td> </tr> </table> <p style="text-align: right;">└ Not recognized as a check digit.</p>	D ₁	D ₂	D ₃	D ₄	D ₅	D ₆	D ₇	D ₈	D ₉
	D ₁	D ₂	D ₃	D ₄	D ₅	D ₆	D ₇	D ₈	D ₉		
Drawing Data	<table border="1"> <tr> <td>D₁</td><td>D₂</td><td>D₃</td><td>D₄</td><td>D₅</td><td>D₆</td><td>D₇</td><td>D₈</td><td>D₉</td> </tr> </table>	D ₁	D ₂	D ₃	D ₄	D ₅	D ₆	D ₇	D ₈	D ₉	
D ₁	D ₂	D ₃	D ₄	D ₅	D ₆	D ₇	D ₈	D ₉			
127 digits or more		Not to be drawn									

(2) Modulus check character check

No. of Input Digits											
Min. 2 digits Max. 126 digits (including C/D)	Input Data	<table border="1"> <tr> <td>D₁</td><td>D₂</td><td>D₃</td><td>D₄</td><td>D₅</td><td>D₆</td><td>D₇</td><td>D₈</td><td>D₉</td> </tr> </table> <p style="text-align: right;">└ To be checked as a modulus check character</p>	D ₁	D ₂	D ₃	D ₄	D ₅	D ₆	D ₇	D ₈	D ₉
	D ₁	D ₂	D ₃	D ₄	D ₅	D ₆	D ₇	D ₈	D ₉		
Drawing Data	<table border="1"> <tr> <td>D₁</td><td>D₂</td><td>D₃</td><td>D₄</td><td>D₅</td><td>D₆</td><td>D₇</td><td>D₈</td><td>D₉</td> </tr> </table>	D ₁	D ₂	D ₃	D ₄	D ₅	D ₆	D ₇	D ₈	D ₉	
D ₁	D ₂	D ₃	D ₄	D ₅	D ₆	D ₇	D ₈	D ₉			
1 digit 127 digits or more		Not to be drawn									

(3) Auto affix of modulus check character

No. of Input Digits											
Max. 125 digits	Input Data	<table border="1"> <tr> <td>D₁</td><td>D₂</td><td>D₃</td><td>D₄</td><td>D₅</td><td>D₆</td><td>D₇</td><td>D₈</td><td>D₉</td> </tr> </table>	D ₁	D ₂	D ₃	D ₄	D ₅	D ₆	D ₇	D ₈	D ₉
	D ₁	D ₂	D ₃	D ₄	D ₅	D ₆	D ₇	D ₈	D ₉		
Drawing Data	<table border="1"> <tr> <td>D₁</td><td>D₂</td><td>D₃</td><td>D₄</td><td>D₅</td><td>D₆</td><td>D₇</td><td>D₈</td><td>D₉</td><td>C/D</td> </tr> </table> <p style="text-align: right;">└ Affix a modulus check character.</p>	D ₁	D ₂	D ₃	D ₄	D ₅	D ₆	D ₇	D ₈	D ₉	C/D
D ₁	D ₂	D ₃	D ₄	D ₅	D ₆	D ₇	D ₈	D ₉	C/D		
126 digits or more		Not to be drawn									

Type of Bar Code: CODE39 (Standard)

(1) No affix

No. of Input Digits																																			
Max. 123 digits	Input Data	<table border="1"> <tr> <td>St</td><td>D₁</td><td>D₂</td><td>D₃</td><td>D₄</td><td>D₅</td><td>D₆</td><td>D₇</td><td>D₈</td><td>D₉</td><td>Sp</td> </tr> <tr> <td colspan="10" style="text-align: center;">Start code</td> <td style="text-align: center;">Stop code</td> </tr> <tr> <td colspan="11" style="text-align: center;">Not recognized as a check digit.</td> </tr> </table>	St	D ₁	D ₂	D ₃	D ₄	D ₅	D ₆	D ₇	D ₈	D ₉	Sp	Start code										Stop code	Not recognized as a check digit.										
	St	D ₁	D ₂	D ₃	D ₄	D ₅	D ₆	D ₇	D ₈	D ₉	Sp																								
Start code										Stop code																									
Not recognized as a check digit.																																			
Drawing Data	<table border="1"> <tr> <td>St</td><td>D₁</td><td>D₂</td><td>D₃</td><td>D₄</td><td>D₅</td><td>D₆</td><td>D₇</td><td>D₈</td><td>D₉</td><td>Sp</td> </tr> <tr> <td colspan="11" style="text-align: center;">_____</td> </tr> </table>	St	D ₁	D ₂	D ₃	D ₄	D ₅	D ₆	D ₇	D ₈	D ₉	Sp	_____																						
St	D ₁	D ₂	D ₃	D ₄	D ₅	D ₆	D ₇	D ₈	D ₉	Sp																									

124 digits or more		Not to be drawn																																	

(2) Modulus 43 check

No. of Input Digits																																			
Min. 2 digits Max. 123 digits (including C/D)	Input Data	<table border="1"> <tr> <td>St</td><td>D₁</td><td>D₂</td><td>D₃</td><td>D₄</td><td>D₅</td><td>D₆</td><td>D₇</td><td>D₈</td><td>D₉</td><td>Sp</td> </tr> <tr> <td colspan="10" style="text-align: center;">Start code</td> <td style="text-align: center;">Stop code</td> </tr> <tr> <td colspan="11" style="text-align: center;">To be checked as modulus 43 C/D</td> </tr> </table>	St	D ₁	D ₂	D ₃	D ₄	D ₅	D ₆	D ₇	D ₈	D ₉	Sp	Start code										Stop code	To be checked as modulus 43 C/D										
	St	D ₁	D ₂	D ₃	D ₄	D ₅	D ₆	D ₇	D ₈	D ₉	Sp																								
Start code										Stop code																									
To be checked as modulus 43 C/D																																			
Drawing Data	<table border="1"> <tr> <td>St</td><td>D₁</td><td>D₂</td><td>D₃</td><td>D₄</td><td>D₅</td><td>D₆</td><td>D₇</td><td>D₈</td><td>D₉</td><td>Sp</td> </tr> <tr> <td colspan="11" style="text-align: center;">_____</td> </tr> </table>	St	D ₁	D ₂	D ₃	D ₄	D ₅	D ₆	D ₇	D ₈	D ₉	Sp	_____																						
St	D ₁	D ₂	D ₃	D ₄	D ₅	D ₆	D ₇	D ₈	D ₉	Sp																									

1 digit 124 digits or more		Not to be drawn																																	

(3) Auto affix of modulus 43

No. of Input Digits																																				
Max. 122 digits	Input Data	<table border="1"> <tr> <td>St</td><td>D₁</td><td>D₂</td><td>D₃</td><td>D₄</td><td>D₅</td><td>D₆</td><td>D₇</td><td>D₈</td><td>D₉</td><td>Sp</td> </tr> <tr> <td colspan="10" style="text-align: center;">Start code</td> <td style="text-align: center;">Stop code</td> </tr> </table>	St	D ₁	D ₂	D ₃	D ₄	D ₅	D ₆	D ₇	D ₈	D ₉	Sp	Start code										Stop code												
	St	D ₁	D ₂	D ₃	D ₄	D ₅	D ₆	D ₇	D ₈	D ₉	Sp																									
Start code										Stop code																										
Drawing Data	<table border="1"> <tr> <td>St</td><td>D₁</td><td>D₂</td><td>D₃</td><td>D₄</td><td>D₅</td><td>D₆</td><td>D₇</td><td>D₈</td><td>D₉</td><td>C/D</td><td>Sp</td> </tr> <tr> <td colspan="11" style="text-align: center;">_____</td> </tr> <tr> <td colspan="11" style="text-align: center;">Affix a modulus 43 C/D.</td> </tr> </table>	St	D ₁	D ₂	D ₃	D ₄	D ₅	D ₆	D ₇	D ₈	D ₉	C/D	Sp	_____											Affix a modulus 43 C/D.											
St	D ₁	D ₂	D ₃	D ₄	D ₅	D ₆	D ₇	D ₈	D ₉	C/D	Sp																									

Affix a modulus 43 C/D.																																				
123 digits or more		Not to be drawn																																		

Type of Bar Code: CODE39 (Full ASCII)

(1) No affix

No. of Input Digits																																			
Max. 60 digits	Input Data	<table border="1"> <tr> <td>St</td><td>D₁</td><td>D₂</td><td>D₃</td><td>D₄</td><td>D₅</td><td>D₆</td><td>D₇</td><td>D₈</td><td>D₉</td><td>Sp</td> </tr> <tr> <td colspan="10">Start code</td> <td>Stop code</td> </tr> <tr> <td colspan="11">Not recognized as a check digit.</td> </tr> </table>	St	D ₁	D ₂	D ₃	D ₄	D ₅	D ₆	D ₇	D ₈	D ₉	Sp	Start code										Stop code	Not recognized as a check digit.										
	St	D ₁	D ₂	D ₃	D ₄	D ₅	D ₆	D ₇	D ₈	D ₉	Sp																								
Start code										Stop code																									
Not recognized as a check digit.																																			
Drawing Data	<table border="1"> <tr> <td>St</td><td>D₁</td><td>D₂</td><td>D₃</td><td>D₄</td><td>D₅</td><td>D₆</td><td>D₇</td><td>D₈</td><td>D₉</td><td>Sp</td> </tr> <tr> <td colspan="11">_____</td> </tr> </table>	St	D ₁	D ₂	D ₃	D ₄	D ₅	D ₆	D ₇	D ₈	D ₉	Sp	_____																						
St	D ₁	D ₂	D ₃	D ₄	D ₅	D ₆	D ₇	D ₈	D ₉	Sp																									

61 digits or more		Not to be drawn																																	

(2) Modulus 43 check

No. of Input Digits																																			
Min. 2 digits Max. 60 digits (including C/D)	Input Data	<table border="1"> <tr> <td>St</td><td>D₁</td><td>D₂</td><td>D₃</td><td>D₄</td><td>D₅</td><td>D₆</td><td>D₇</td><td>D₈</td><td>D₉</td><td>Sp</td> </tr> <tr> <td colspan="10">Start code</td> <td>Stop code</td> </tr> <tr> <td colspan="11">To be checked as modulus 43 C/D</td> </tr> </table>	St	D ₁	D ₂	D ₃	D ₄	D ₅	D ₆	D ₇	D ₈	D ₉	Sp	Start code										Stop code	To be checked as modulus 43 C/D										
	St	D ₁	D ₂	D ₃	D ₄	D ₅	D ₆	D ₇	D ₈	D ₉	Sp																								
Start code										Stop code																									
To be checked as modulus 43 C/D																																			
Drawing Data	<table border="1"> <tr> <td>St</td><td>D₁</td><td>D₂</td><td>D₃</td><td>D₄</td><td>D₅</td><td>D₆</td><td>D₇</td><td>D₈</td><td>D₉</td><td>Sp</td> </tr> <tr> <td colspan="11">_____</td> </tr> </table>	St	D ₁	D ₂	D ₃	D ₄	D ₅	D ₆	D ₇	D ₈	D ₉	Sp	_____																						
St	D ₁	D ₂	D ₃	D ₄	D ₅	D ₆	D ₇	D ₈	D ₉	Sp																									

1 digit 61 digits or more		Not to be drawn																																	

(3) Auto affix of modulus 43

No. of Input Digits																																			
Max. 60 digits	Input Data	<table border="1"> <tr> <td>St</td><td>D₁</td><td>D₂</td><td>D₃</td><td>D₄</td><td>D₅</td><td>D₆</td><td>D₇</td><td>D₈</td><td>D₉</td><td>Sp</td> </tr> <tr> <td colspan="10">Start code</td> <td>Stop code</td> </tr> </table>	St	D ₁	D ₂	D ₃	D ₄	D ₅	D ₆	D ₇	D ₈	D ₉	Sp	Start code										Stop code											
	St	D ₁	D ₂	D ₃	D ₄	D ₅	D ₆	D ₇	D ₈	D ₉	Sp																								
Start code										Stop code																									
Drawing Data	<table border="1"> <tr> <td>St</td><td>D₁</td><td>D₂</td><td>D₃</td><td>D₄</td><td>D₅</td><td>D₆</td><td>D₇</td><td>D₈</td><td>D₉</td><td>C/D</td><td>Sp</td> </tr> <tr> <td colspan="11">_____</td> </tr> <tr> <td colspan="11">Affix a modulus 43 C/D.</td> </tr> </table>	St	D ₁	D ₂	D ₃	D ₄	D ₅	D ₆	D ₇	D ₈	D ₉	C/D	Sp	_____											Affix a modulus 43 C/D.										
St	D ₁	D ₂	D ₃	D ₄	D ₅	D ₆	D ₇	D ₈	D ₉	C/D	Sp																								

Affix a modulus 43 C/D.																																			
61 digits or more		Not to be drawn																																	

NOTE: Numerals under bars are not characters corresponding to the bars but the characters of the codes received are drawn.

Type of Bar Code: NW7

- (1) No affix
- C/D check
- Auto affix

No. of Input Digits																								
Max. 125 digits	Input Data	<table border="1"> <tr> <td>St</td><td>D₁</td><td>D₂</td><td>D₃</td><td>D₄</td><td>D₅</td><td>D₆</td><td>D₇</td><td>D₈</td><td>D₉</td><td>Sp</td> </tr> <tr> <td colspan="10">Start code</td> <td>Stop code</td> </tr> </table>	St	D ₁	D ₂	D ₃	D ₄	D ₅	D ₆	D ₇	D ₈	D ₉	Sp	Start code										Stop code
	St	D ₁	D ₂	D ₃	D ₄	D ₅	D ₆	D ₇	D ₈	D ₉	Sp													
Start code										Stop code														
Drawing Data	<table border="1"> <tr> <td>St</td><td>D₁</td><td>D₂</td><td>D₃</td><td>D₄</td><td>D₅</td><td>D₆</td><td>D₇</td><td>D₈</td><td>D₉</td><td>Sp</td> </tr> <tr> <td colspan="11">_____</td> </tr> </table>	St	D ₁	D ₂	D ₃	D ₄	D ₅	D ₆	D ₇	D ₈	D ₉	Sp	_____											
St	D ₁	D ₂	D ₃	D ₄	D ₅	D ₆	D ₇	D ₈	D ₉	Sp														

126 digits or more		Not to be drawn																						

Type of Bar Code: No auto selection of CODE128 (Character ">" to be also counted as a digit)

- (1) No affix
- PSEUDO103 check
- Auto affix of PSEUDO103

No. of Input Digits		
Min. 3 digits Max. 125 digits (including start code)	Input Data	St D ₁ D ₂ D ₃ D ₄ D ₅ D ₆ D ₇ D ₈ D ₉ D ₁₀ D ₁₁
	Drawing Data	St D ₁ D ₂ D ₃ D ₄ D ₅ D ₆ D ₇ D ₈ D ₉ D ₁₀ D ₁₁ C/D Sp <div style="text-align: right; margin-top: 5px;">└ Affix PSEUDO103 C/D.</div>
2 digits or less 126 digits or more		Not to be drawn

NOTE: The following characters are not drawn as numerals under bars.
 NUL (00H) to US (1FH), FNC1, FNC2, FNC3, SHIFT, CODE A, CODE B, CODE C

Type of Bar Code: Auto selection of CODE128

- (1) No affix
- C/D check
- Auto affix of C/D

No. of Input Digits		
Max. 60 digits	Input Data	D ₁ D ₂ D ₃ D ₄ D ₅ D ₆ D ₇ D ₈ D ₉ D ₁₀ D ₁₁
	Drawing Data	St D ₁ D ₂ D ₃ D ₄ AD D ₅ D ₆ D ₇ AD D ₈ D ₉ D ₁₀ D ₁₁ C/D Sp <div style="display: flex; justify-content: space-between; margin-top: 5px;"> <div style="width: 30%;">└ Start code</div> <div style="width: 40%;">└ Selection code</div> <div style="width: 25%;">└ Stop code</div> </div> <div style="text-align: right; margin-top: 5px;">└ Affix PSEUDO103 C/D.</div>
61 digits or more		Not to be drawn

NOTE: The following characters are not drawn as numerals under bars.
 NUL (00H) to US (1FH), FNC1, FNC2, FNC3, SHIFT, CODE A, CODE B, CODE C

Type of Bar Code: CODE93

- (1) No affix
- C/D check
- Auto affix of C/D

No. of Input Digits														
Max. 60 digits	Input Data	D ₁ D ₂ D ₃ D ₄ D ₅ D ₆ D ₇ D ₈ D ₉												
	Drawing Data	<table border="1" style="width: 100%; border-collapse: collapse;"> <tr> <td style="width: 20px;">St</td> <td style="width: 20px;">D₁</td> <td style="width: 20px;">D₂</td> <td style="width: 20px;">D₃</td> <td style="width: 20px;">D₄</td> <td style="width: 20px;">D₅</td> <td style="width: 20px;">D₆</td> <td style="width: 20px;">D₇</td> <td style="width: 20px;">D₈</td> <td style="width: 20px;">D₉</td> <td style="width: 20px;">C/D₁</td> <td style="width: 20px;">C/D₂</td> <td style="width: 20px;">Sp</td> </tr> </table> <p style="margin-left: 40px;"> Start code Stop code Affix a modulus 47 "K" C/D. Affix a modulus 47 "C" C/D. </p>	St	D ₁	D ₂	D ₃	D ₄	D ₅	D ₆	D ₇	D ₈	D ₉	C/D ₁	C/D ₂
St	D ₁	D ₂	D ₃	D ₄	D ₅	D ₆	D ₇	D ₈	D ₉	C/D ₁	C/D ₂	Sp		
61 digits or more		Not to be drawn												

NOTE: Numerals under bars are not characters corresponding to the bars but the characters of the codes received are drawn.

Type of Bar Code: UCC/EAN128

- (1) No affix
- C/D check
- Auto affix of C/D

No. of Input Digits																			
19 digits	Input Data	D ₁ D ₂ D ₃ D ₄ D ₅ D ₆ --- D ₁₄ D ₁₅ D ₁₆ D ₁₇ D ₁₈ D ₁₉																	
	Drawing Data	<table border="1" style="width: 100%; border-collapse: collapse;"> <tr> <td style="width: 20px;">St</td> <td style="width: 20px;">FNC1</td> <td style="width: 20px;">D₁</td> <td style="width: 20px;">D₂</td> <td style="width: 20px;">D₃</td> <td style="width: 20px;">D₄</td> <td style="width: 20px;">D₅</td> <td style="width: 20px;">D₆</td> <td style="width: 20px;">---</td> <td style="width: 20px;">D₁₄</td> <td style="width: 20px;">D₁₅</td> <td style="width: 20px;">D₁₆</td> <td style="width: 20px;">D₁₇</td> <td style="width: 20px;">D₁₈</td> <td style="width: 20px;">D₁₉</td> <td style="width: 20px;">C/D₁</td> <td style="width: 20px;">C/D₂</td> <td style="width: 20px;">Sp</td> </tr> </table> <p style="margin-left: 40px;"> Start code Affix a modulus 10 C/D. Affix a modulus 11 C/D. Stop code </p>	St	FNC1	D ₁	D ₂	D ₃	D ₄	D ₅	D ₆	---	D ₁₄	D ₁₅	D ₁₆	D ₁₇	D ₁₈	D ₁₉	C/D ₁	C/D ₂
St	FNC1	D ₁	D ₂	D ₃	D ₄	D ₅	D ₆	---	D ₁₄	D ₁₅	D ₁₆	D ₁₇	D ₁₈	D ₁₉	C/D ₁	C/D ₂	Sp		
Other than 19 digits		Not to be drawn																	

Type of Bar Code: POSTNET

(1) Auto affix of dedicated C/D

No. of Input Digits																		
5 digits	Input Data	D ₁ D ₂ D ₃ D ₄ D ₅																
	Drawing Data	<table border="1" style="display: inline-table; border-collapse: collapse;"> <tr> <td>St</td><td>D₁</td><td>D₂</td><td>D₃</td><td>D₄</td><td>D₅</td><td>C/D</td><td>Sp</td> </tr> </table> Start code (under St to D ₅) Stop code (under C/D) Dedicated check digit (under Sp)	St	D ₁	D ₂	D ₃	D ₄	D ₅	C/D	Sp								
St	D ₁	D ₂	D ₃	D ₄	D ₅	C/D	Sp											
9 digits	Input Data	D ₁ D ₂ D ₃ D ₄ D ₅ D ₆ D ₇ D ₈ D ₉																
	Drawing Data	<table border="1" style="display: inline-table; border-collapse: collapse;"> <tr> <td>St</td><td>D₁</td><td>D₂</td><td>D₃</td><td>D₄</td><td>D₅</td><td>D₆</td><td>D₇</td><td>D₈</td><td>D₉</td><td>C/D</td><td>Sp</td> </tr> </table> Start code (under St to D ₉) Stop code (under C/D) Dedicated check digit (under Sp)	St	D ₁	D ₂	D ₃	D ₄	D ₅	D ₆	D ₇	D ₈	D ₉	C/D	Sp				
St	D ₁	D ₂	D ₃	D ₄	D ₅	D ₆	D ₇	D ₈	D ₉	C/D	Sp							
11 digits	Input Data	D ₁ D ₂ D ₃ D ₄ D ₅ D ₆ D ₇ D ₈ D ₉ D ₁₀ D ₁₁																
	Drawing Data	<table border="1" style="display: inline-table; border-collapse: collapse;"> <tr> <td>St</td><td>D₁</td><td>D₂</td><td>D₃</td><td>D₄</td><td>D₅</td><td>C/D</td><td>Sp</td><td>Fr</td><td>D₆</td><td>D₇</td><td>D₈</td><td>D₉</td><td>D₁₀</td><td>D₁₁</td><td>C/D</td><td>Fr</td> </tr> </table> Start code (under St to D ₅) Frame (under Fr) Stop code (under C/D) Dedicated check digit (under C/D)	St	D ₁	D ₂	D ₃	D ₄	D ₅	C/D	Sp	Fr	D ₆	D ₇	D ₈	D ₉	D ₁₀	D ₁₁	C/D
St	D ₁	D ₂	D ₃	D ₄	D ₅	C/D	Sp	Fr	D ₆	D ₇	D ₈	D ₉	D ₁₀	D ₁₁	C/D	Fr		
Other than 5, 9, and 11 digits		Not to be drawn																

Type of Bar Code: RM4SCC

(1) Auto affix of dedicated C/D

No. of Input Digits																
12 digits	Input Data	(St) D ₁ D ₂ D ₃ D ₄ D ₅ D ₆ D ₇ D ₈ D ₉ D ₁₀ D ₁₁ D ₁₂ (Sp)														
	Drawing Data	<table border="1" style="display: inline-table; border-collapse: collapse;"> <tr> <td>St</td><td>D₁</td><td>D₂</td><td>D₃</td><td>D₄</td><td>D₅</td><td>D₆</td><td>D₇</td><td>D₈</td><td>D₉</td><td>D₁₀</td><td>D₁₁</td><td>D₁₂</td><td>C/D</td><td>Sp</td> </tr> </table> Start code (under St to D ₁₂) Stop code (under Sp) Dedicated check digit (under C/D)	St	D ₁	D ₂	D ₃	D ₄	D ₅	D ₆	D ₇	D ₈	D ₉	D ₁₀	D ₁₁	D ₁₂	C/D
St	D ₁	D ₂	D ₃	D ₄	D ₅	D ₆	D ₇	D ₈	D ₉	D ₁₀	D ₁₁	D ₁₂	C/D	Sp		
13 digits or more		Not to be drawn														

Type of Bar Code: KIX CODE

(1) No affix

No. of Input Digits		
18 digits	Input Data	D ₁ D ₂ D ₃ D ₄ D ₅ D ₆ D ₇ D ₈ D ₉ D ₁₀ D ₁₁ D ₁₂ D ₁₃ D ₁₄ D ₁₅ D ₁₆ D ₁₇ D ₁₈
	Drawing Data	D ₁ D ₂ D ₃ D ₄ D ₅ D ₆ D ₇ D ₈ D ₉ D ₁₀ D ₁₁ D ₁₂ D ₁₃ D ₁₄ D ₁₅ D ₁₆ D ₁₇ D ₁₈
19 digits or more		Not to be drawn

Type of Bar Code: Customer bar code

(1) Auto affix of dedicated C/D

No. of Input Digits																																														
20 digits	Input Data	D ₁ D ₂ D ₃ D ₄ D ₅ D ₆ D ₇ D ₈ D ₉ D ₁₀ D ₁₁ D ₁₂ D ₁₃ D ₁₄ D ₁₅ D ₁₆ D ₁₇ D ₁₈ D ₁₉ D ₂₀																																												
	Drawing Data	<table border="1" style="width: 100%; border-collapse: collapse;"> <tr> <td style="width: 20px;">St</td> <td>D₁</td><td>D₂</td><td>D₃</td><td>D₄</td><td>D₅</td><td>D₆</td><td>D₇</td><td>D₈</td><td>D₉</td><td>D₁₀</td><td>D₁₁</td><td>D₁₂</td><td>D₁₃</td><td>D₁₄</td><td>D₁₅</td><td>D₁₆</td><td>D₁₇</td><td>D₁₈</td><td>D₁₉</td><td>D₂₀</td> <td>C/D</td><td>Sp</td> </tr> <tr> <td colspan="10" style="text-align: center;">Start code</td> <td colspan="10" style="text-align: center;">Dedicated check digit</td> <td colspan="2" style="text-align: center;">Stop code</td> </tr> </table>	St	D ₁	D ₂	D ₃	D ₄	D ₅	D ₆	D ₇	D ₈	D ₉	D ₁₀	D ₁₁	D ₁₂	D ₁₃	D ₁₄	D ₁₅	D ₁₆	D ₁₇	D ₁₈	D ₁₉	D ₂₀	C/D	Sp	Start code										Dedicated check digit										Stop code
St	D ₁	D ₂	D ₃	D ₄	D ₅	D ₆	D ₇	D ₈	D ₉	D ₁₀	D ₁₁	D ₁₂	D ₁₃	D ₁₄	D ₁₅	D ₁₆	D ₁₇	D ₁₈	D ₁₉	D ₂₀	C/D	Sp																								
Start code										Dedicated check digit										Stop code																										
21 digits or more		Data of up to 20 digits is drawn. Data of 21 digits or more is discarded.																																												

Type of Bar Code: Highest priority customer bar code

(1) Auto affix of dedicated C/D

No. of Input Digits																																														
19 digits	Input Data	D ₁ D ₂ D ₃ D ₄ D ₅ D ₆ D ₇ D ₈ D ₉ D ₁₀ D ₁₁ D ₁₂ D ₁₃ D ₁₄ D ₁₅ D ₁₆ D ₁₇ D ₁₈ D ₁₉																																												
	Drawing Data	<table border="1" style="width: 100%; border-collapse: collapse;"> <tr> <td style="width: 20px;">St</td> <td>D₁</td><td>D₂</td><td>D₃</td><td>D₄</td><td>D₅</td><td>D₆</td><td>D₇</td><td>D₈</td><td>D₉</td><td>D₁₀</td><td>D₁₁</td><td>D₁₂</td><td>D₁₃</td><td>D₁₄</td><td>D₁₅</td><td>D₁₆</td><td>D₁₇</td><td>D₁₈</td><td>D₁₉</td> <td>CC7</td><td>C/D</td><td>Sp</td> </tr> <tr> <td colspan="10" style="text-align: center;">Start code</td> <td colspan="10" style="text-align: center;">Dedicated check digit</td> <td colspan="2" style="text-align: center;">Stop code</td> </tr> </table>	St	D ₁	D ₂	D ₃	D ₄	D ₅	D ₆	D ₇	D ₈	D ₉	D ₁₀	D ₁₁	D ₁₂	D ₁₃	D ₁₄	D ₁₅	D ₁₆	D ₁₇	D ₁₈	D ₁₉	CC7	C/D	Sp	Start code										Dedicated check digit										Stop code
St	D ₁	D ₂	D ₃	D ₄	D ₅	D ₆	D ₇	D ₈	D ₉	D ₁₀	D ₁₁	D ₁₂	D ₁₃	D ₁₄	D ₁₅	D ₁₆	D ₁₇	D ₁₈	D ₁₉	CC7	C/D	Sp																								
Start code										Dedicated check digit										Stop code																										
20 digits or more		Data of up to 19 digits is drawn. Data of 20 digits or more is discarded.																																												

Type of Bar Code: RSS-14, RSS-14 Stacked, RSS-14 Stacked Omnidirectional, RSS Limited

(1) Auto affix of dedicated C/D

No. of Input Digits																												
13 digits	Input Data	D ₁ D ₂ D ₃ D ₄ D ₅ D ₆ D ₇ D ₈ D ₉ D ₁₀ D ₁₁ D ₁₂ D ₁₃																										
	Drawing Data	<table border="1" style="width: 100%; border-collapse: collapse;"> <tr> <td style="width: 20px;">D₁</td><td>D₂</td><td>D₃</td><td>D₄</td><td>D₅</td><td>D₆</td><td>D₇</td><td>D₈</td><td>D₉</td><td>D₁₀</td><td>D₁₁</td><td>D₁₂</td><td>D₁₃</td><td>C/D</td> </tr> <tr> <td colspan="13" style="text-align: center;">Dedicated check digit</td> </tr> </table>	D ₁	D ₂	D ₃	D ₄	D ₅	D ₆	D ₇	D ₈	D ₉	D ₁₀	D ₁₁	D ₁₂	D ₁₃	C/D	Dedicated check digit											
D ₁	D ₂	D ₃	D ₄	D ₅	D ₆	D ₇	D ₈	D ₉	D ₁₀	D ₁₁	D ₁₂	D ₁₃	C/D															
Dedicated check digit																												
14 digits or more		Not to be drawn																										

Type of Bar Code: RSS Expanded

(1) Auto affix of dedicated C/D

No. of Input Digits																												
70 digits	Input Data	D ₁ D ₂ D ₃ D ₄ D ₅ D ₆ D ₇ D ₈ D ₉ D ₁₀ D ₁₁ D ₁₂ D ₁₃																										
	Drawing Data	<table border="1" style="width: 100%; border-collapse: collapse;"> <tr> <td style="width: 20px;">D₁</td><td>D₂</td><td>D₃</td><td>D₄</td><td>D₅</td><td>D₆</td><td>D₇</td><td>D₈</td><td>D₉</td><td>D₁₀</td><td>D₁₁</td><td>D₁₂</td><td>D₁₃</td><td>C/D</td> </tr> <tr> <td colspan="13" style="text-align: center;">Dedicated check digit</td> </tr> </table>	D ₁	D ₂	D ₃	D ₄	D ₅	D ₆	D ₇	D ₈	D ₉	D ₁₀	D ₁₁	D ₁₂	D ₁₃	C/D	Dedicated check digit											
D ₁	D ₂	D ₃	D ₄	D ₅	D ₆	D ₇	D ₈	D ₉	D ₁₀	D ₁₁	D ₁₂	D ₁₃	C/D															
Dedicated check digit																												
71 digits or more		Not to be drawn NOTE: Some data cannot be drawn even if the number of input digits is less than 70.																										

15. AUTOMATIC ADDING OF START/STOP CODES

Type of Bar Code	Designation of Start/Stop Codes	Input Data	Drawing Data			
CODE 39	Omit (No designation)	12345ABC	Standard	*12345ABC*		
			Full ASCII	*12345ABC*		
		*12345ABC	Standard	*12345ABC*		
			Full ASCII	*12345ABC*		
		12345ABC*	Standard	*12345ABC*		
			Full ASCII	*12345ABC*		
		12345ABC	Standard	*12345ABC*		
			Full ASCII	*12345ABC*		
		12345*ABC	Standard	*12345*ABC*		
			Full ASCII	*12345/JABC*		
		**12345ABC	Standard	**12345ABC*		
			Full ASCII	*/J12345ABC*		
		*12345ABC**	Standard	*12345ABC**		
			Full ASCII	*12345ABC/J*		
		*12345*ABC*	Standard	*12345*ABC*		
			Full ASCII	*12345/JABC*		
			Add start code	12345ABC	Standard	*12345ABC
				Full ASCII	*12345ABC	
	*12345ABC	Standard		**12345ABC		
		Full ASCII		*/J12345ABC		
	12345ABC*	Standard		*12345ABC*		
		Full ASCII		*12345ABC*		
	12345ABC	Standard		**12345ABC*		
		Full ASCII		*/J12345ABC*		
	12345*ABC	Standard		*12345*ABC		
		Full ASCII		*12345/JABC		
	12345ABC	Standard		*12345ABC		
		Full ASCII		*/J/J12345ABC		
	*12345ABC**	Standard		**12345ABC**		
		Full ASCII		*/J12345ABC/J*		
	*12345*ABC*	Standard		**12345*ABC*		
		Full ASCII		*/J12345/JABC*		
		Add stop code		12345ABC	Standard	12345ABC*
				Full ASCII	12345ABC*	
	*12345ABC		Standard	*12345ABC*		
			Full ASCII	*12345ABC*		
12345ABC*	Standard		12345ABC**			
	Full ASCII		12345ABC/J*			
12345ABC	Standard		*12345ABC**			
	Full ASCII		*12345ABC/J*			
12345*ABC	Standard		12345*ABC*			
	Full ASCII		12345/JABC*			
**12345ABC	Standard		**12345ABC*			
	Full ASCII		*/J12345ABC*			
*12345ABC**	Standard		*12345ABC***			
	Full ASCII		*12345ABC/J/J*			
*12345*ABC*	Standard		*12345*ABC**			
	Full ASCII		*12345/JABC/J*			

Type of Bar Code	Designation of Start/Stop Codes	Input Data	Drawing Data	
CODE 39	Start/stop code not added	12345ABC	Standard	12345ABC
			Full ASCII	12345ABC
		*12345ABC	Standard	*12345ABC
			Full ASCII	*12345ABC
		12345ABC*	Standard	12345ABC*
			Full ASCII	12345ABC*
		12345ABC	Standard	*12345ABC*
			Full ASCII	*12345ABC*
		12345*ABC	Standard	12345*ABC
			Full ASCII	12345/JABC
		**12345ABC	Standard	**12345ABC
			Full ASCII	*/J12345ABC
		*12345ABC**	Standard	*12345ABC**
			Full ASCII	*12345ABC/J*
*12345*ABC*	Standard	*12345*ABC*		
	Full ASCII	*12345/JABC*		

Type of Bar Code	Designation of Start/Stop Codes	Input Data	Drawing Data
NW7	Omit (No designation)	12345678	a12345678a
		a12345678	a12345678
		12345678c	12345678c
		b12345678d	b12345678d
		12345a678	a12345a678a
		ab12345678	ab12345678
		a12345678bc	a12345678bc
		d12345b678c	d12345b678c
	Add start code	12345678	a12345678
		a12345678	aa12345678
		12345678c	a12345678c
		b12345678d	ab12345678d
		12345a678	a12345a678
		ab12345678	aab12345678
		a12345678bc	aa12345678bc
		d12345b678c	ad12345b678c
	Add stop code	12345678	12345678a
		a12345678	a12345678a
		12345678c	12345678ca
		b12345678d	b12345678da
		12345a678	12345a678a
		ab12345678	ab12345678a
		a12345678bc	a12345678bca
		d12345b678c	d12345b678ca
	Start/stop code not added	12345678	12345678
		a12345678	a12345678
		12345678c	12345678c
		b12345678d	b12345678d
		12345a678	12345a678
		ab12345678	ab12345678
		a12345678bc	a12345678bc
		d12345b678c	d12345b678c